

TM 11-5820-555-24P

**TECHNICAL MANUAL**

**ORGANIZATIONAL, DIRECT SUPPORT, AND GENERAL SUPPORT  
MAINTENANCE REPAIR PARTS AND SPECIAL TOOLS LIST  
(INCLUDING DEPOT REPAIR PARTS AND SPECIAL TOOLS)**

**TRANSCEIVER KWT-6 TYPE 8**

---

**HEADQUARTERS DEPARTMENT OF THE ARMY  
NOVEMBER 1973**

TECHNICAL MANUAL }  
 No. 11-5820-55-24P }

HEADQUARTERS  
 DEPARTMENT OF THE ARMY  
 WASHINGTON, D.C., 29 November 1978

**ORGANIZATIONAL, DIRECT SUPPORT, AND GENERAL SUPPORT  
 MAINTENANCE REPAIR PARTS AND SPECIAL TOOLS LIST  
 (INCLUDING DEPOT REPAIR PARTS AND SPECIAL TOOLS)  
 TRANSCEIVER KWT-6 TYPE 8**

Current as of 15 January 1973

SECTION	Paragraph	Page
I. INTRODUCTION		
Scope.....	1-1	1-1
General.....	1-2	1-1
Explanation of columns.....	1-3	1-1
Special information.....	1-4	1-2
Location of repair parts.....	1-5	1-2
Federal supply code for manufacturers.....	1-6	1-3
Reporting of Equipment publication improvements.....	1-7	1-5
II. REPAIR PARTS FOR ORGANIZATIONAL MAINTENANCE.....		2-1
Group 01. Frequency Generator 786E-1.....		2-1
02. Sideband Generator 786F-1.....		2-2
03. Power Supply PP-2154/U.....		2-2
04. Power Supply PP-2153/U.....		2-3
05. Amplifier, Power 367A-3.....		2-4
06. Audio Control Unit 159B-1.....		2-5
07. Cooler, Air, Electrical Equipment HD-347/U.....		2-5
08. Comparator Assembly CM-126/UR.....		2-6
09. Interconnecting Box 153H-3.....		2-6
10. Handset Adapter Assembly C-2691/URC.....		2-6
11. CW and FSK CW-730/URC.....		2-6
12. Rack, Electrical Equipment MT-2251/U.....		2-7
13. Dummy Load, Electrical 172J-1.....		2-7
14. Network, Antenna 18OU-2.....		2-7
SPECIAL TOOLS, TEST AND SUPPORT EQUIPMENT FOR ORGANIZATIONAL MAINTENANCE (NOT APPLICABLE)		
III. REPAIR PARTS FOR DIRECT SUPPORT, GENERAL SUPPORT, AND DEPOT MAINTENANCE.....		3-1
Group 01. Frequency Generator 7863.....		3-1
02. Sideband Generator 786F-1.....		3-113
03. Power Supply PP-2154/U.....		3-156
04. Power Supply PP-2153/U.....		3-163
05. Amplifier, Power 367A-3.....		3-173
06. Audio Control Unit 159B-1.....		3-201
07. Cooler, Air, Electrical Equipment HD-347/U.....		3-213
08. Comparator Assembly CM-126/UR.....		3-216
09. Interconnecting Box 153H-3.....		3-222
10. Handset Adapter Assembly C-2691/URC.....		3-227
11. CW and RSK CW-730/URC.....		3-232
12. Rack, Electrical Equipment MT-2251/U.....		3-243
13. Dummy Load, Electrical 172J-1.....		3-252
14. Network, Antenna 18OU-2.....		3-254
SPECIAL TOOLS, TEST AND SUPPORT EQUIPMENT FOR DIRECT SUPPORT, GENERAL SUPPORT AND DEPOT MAINTENANCE (NOT APPLICABLE)		
IV. INDEX-FEDERAL STOCK NUMBER AND REFERENCE NUMBER CROSS-REFERENCE TO FIGURE AND ITEM NUMBER OR REFERENCE DESIGNATION.....		4-1
V. INDEX-REFERENCE DESIGNATION CROSS-REFERENCE TO PAGE NUMBER.....		5-1

LIST OF ILLUSTRATIONS

Number	Title	Page
3-1.	Major components, Transceiver KWT-6, front view -----	3-268
3-2.	Frequency Generator 786E-1, rear view, cover removed (1A4)-----	3-269
3-3.	Frequency Generator 786E-1, front view (1A4) -----	3-270
3-4.	Frequency Generator 7863-1, module location (1A4) -----	3-271
3-5.	Frequency divider module (1A4A1) -----	3-272
3-6.	Stabilized Master Oscillator, Model A, master oscillator assembly (1A4A3) _____	3-273
3-7.	Stabilized Master Oscillator Module, Model C, i-f mixer assembly (1A4A3A3) ----	3-274
3-8.	Stabilized master oscillator module, 4-kc spectrum generator assembly (1A4A3A6) ____	3-275
3-9.	Stabilized master oscillator module, reference i-f amplifier (1A4A3A7) _____	3-276
3-10.	Stabilized Master Oscillator, Model B, i-f amplifier board (1A4A3A2)-----	3-277
3-11.	Stabilized Master Oscillator, Models B and C, meter amplifier board (1A4A3A8) _____	3-278
3-12.	Sidestep oscillator module (1A4A2) -----	3-279
3-13.	R-F Tuner Module, Model B, front view (1A4A4)-----	3-280
3-14.	R-F tuner module, rear view (1A4A4) -----	3-281
3-15.	R-F tuner module, capacitor location (1A4A4) -----	3-282
3-16.	R-F tuner module, front view (1A4A4) -----	3-283
3-17.	Reference oscillator module (1A4A5)-----	3-284
3-18.	Sideband Generator 786F-1, module location (1A5)-----	3-285
3-19.	TGC module and tgc-vox anti-vox module, tgc assembly, cover removed (1A5A1) ----	3-286
3-20.	Sideband Generator 786F-1 chassis, rear view, cover removed (1A5A7) -----	3-287
3-21.	Sideband Generator 786F-1 chassis, front view (1A5A7) -----	3-288
3-22.	Sideband Generator 786F-1 chassis, rear view (1A5A7) -----	3-289
3-23.	LSB i-f/a-f amplifier module, front view, cover removed (1A5A5) -----	3-290
3-24.	LSB i-f/a-f amplifier module, rear view, cover removed (1A5A5) -----	3-291
3-25.	USB i-f/a-f amplifier module, front view, cover removed (1A5A4) -----	3-292
3-26.	USB i-f/a-f amplifier module, rear view, cover removed (1A5A4) -----	3-293
3-27.	Carrier generator module, front view, cover removed (1A5A2) -----	3-294
3-28.	Carrier generator module, front view, cover removed (1A5A2) _____	3-295
3-29.	Balanced modulator module, usb modulator assembly, cover removed (1A5A3A1) ----	3-296
3-30.	Balanced modulator module, lsb modulator assembly, cover removed (1A5A3A2) ----	3-297
3-31.	AM i-f/a-f amplifier module, front view, cover removed (1A5A6)-----	3-298
3-32.	AM i-f/a-f amplifier module, rear view, cover removed (1A5A6) _____	3-299
3-33.	Low-Voltage Power Supply PP-2154/U, front view, cover removed (1A10)-----	3-300
3-34.	Low-Voltage Power Supply PP-2154/U, rear view, cover removed (1A10) - - - - -	3-301
3-35.	High-Voltage Power Supply PP-2153/U, front view, cover removed (1A12) -----	3-302
3-36.	Power Amplifier 367A-3, front panel, rear view (1A3) _____	3-303
3-37.	Power Amplifier 367A-3, front view, front panel removed (1A3) _____	3-304
3-38.	Power Amplifier 367A-3, rear view, cover removed (1A3) -----	3-305
3-39.	Audio and Control Unit 159B-1, module location (1A7) _____	3-306
3-40.	Mike or line amplifier module, component side (1A7A1, 1A7A2, and 1A7A3) _____	3-307
3-41.	Mike or line amplifier module, wiring side (1A7A1, 1A7A2, and 1A7A3) _____	3-308
3-42.	Audio and Control Unit 159B-1 chassis, front view (1A7) -----	3-309
3-43.	Audio and Control Unit 159B-1 chassis, rear view (1A7) -----	3-310
3-44.	Speaker amplifier module, wiring side (1A7A4)-----	3-311
3-45.	Speaker amplifier module, component side (1A7A7) -----	3-312
3-46.	Blower HD-347/U, front cover and filter removed (1A11) -----	3-313
3-47.	Frequency Comparator CM-126/UR, front view, cover removed (1A8) -----	3-314
3-48.	Frequency Comparator CM-126/UR, rear view, cover removed (1A8)-----	3-315
3-49.	Thermal relay input protector, bottom view, cover removed (1A1) - - - - -	3-316
3-50.	Handset adapter, front view, cover removed (1A9) -----	3-317
3-51.	Handset adapter, rear view, cover removed (1A9)-----	3-318
3-52.	CW and fsk unit, front view, cover removed (1A6)-----	3-319
3-53.	CW and fsk unit, rear view, cover removed (1A6) -----	3-320

Number	Title	Page
3-54.	BFO subassembly (1A6A1)-----	3-321
3-55.	Dynamic handset (1A13A3) -----	3-322
3-56.	Dummy Antenna 172J-1, cover removed (1A14)-----	3-323
3-57.	Antenna Network 180U-2, operating controls (1A2) _____	3-324
3-58.	Antenna Network 180U-2, input and output connectors (1A2) -----	3-325

**SECTION I**  
**INTRODUCTION**

**1-1. Scope**

This manual lists repair parts required for the performance of organizational, direct support, general support, and depot maintenance of the Transceiver KWT-6 Type 8.

NOTE

No special tools, test, or support equipment are required.

**1-2. General**

This Repair Parts List is divided into the following sections:

a. **Repair Parts for Organizational Maintenance-Section II.** A list of repair parts authorized for the performance of maintenance at the organizational level.

b. **Repair Parts for Direct Support, General Support, and Depot Maintenance-Section III.** A list of repair parts authorized for the performance of maintenance at the direct support, general support, and depot level.

c. **Index-Federal Stock Number and Reference Number Cross-Reference to Figure and Item Number or Reference Designation-Section IV** A list of Federal stock numbers in ascending numerical sequence, followed by a list of reference numbers in ascending alpha-numeric sequence, cross-referenced to the illustration figure number and reference designation.

d. **Index-Reference Designation Cross-Reference to Page Number-Section V.** A list of reference designations cross-referenced to page numbers.

**1-3. Explanation of Columns**

The following provides an explanation of columns in the tabular lists:

a. **Source, Maintenance, and Recoverability Codes (SMR).**

(1) Source code indicates the selection status and source for the listed item. Source codes are:

Code	Explanation
P-	Repair parts which are stocked in or sup-

Code	Explanation
	plied from the GSA/DSA, or Army supply system, and authorized for use at indicated maintenance categories.
P2-	Repair parts which are procured and stocked for insurance purposes because the combat or military essentiality of the end item dictates that a minimum quantity be available in the supply system.
P9-	Assigned to items which are NSA design controlled: unique repair parts, special tools, test measuring and diagnostic equipment, which are stocked and supplied by the Army COMSEC logistic system and which are not subject to the provisions of AR 380-41.
P10-	Assigned to items which are NSA design controlled: special tools, test, measuring and diagnostic equipment for COMSEC support, which are accountable under the provisions of AR 380-41, and which are stocked and supplied by the Army COMSEC logistic system.
M-	Repair parts which are not procured or stocked, but are to be manufactured at indicated maintenance levels.
A-	Assemblies which are not procured or stocked as such, but are made up of two or more units. Such component units carry individual stock numbers and descriptions, are procured and stocked separately, and can be assembled to form the required assembly at indicated maintenance categories.
X--	Parts and assemblies which are not procured or stocked and the mortality of which normally is below that of the applicable end item or component. The failure of such part or assembly should result in retirement of the end item from the supply system.
X1-	Repair parts which are not procured or stocked. The requirement for such items will be filled by use of the next higher assembly or component.

<i>Code</i>	<i>Explanation</i>
X2-	Repair parts which are not stocked. The indicated maintenance category requiring such repair parts will attempt to obtain same through cannibalization. Where such repair parts are not obtainable through cannibalization, requirements will be requisitioned, with accompanying justification, through normal supply channels.
G-	Major assemblies that are procured with PEMA funds for initial issue only as exchange assemblies at DSU and GSU level. These assemblies will not be stocked above DS and GS level or returned to depot supply level.

(2) Maintenance code indicates the lowest category of maintenance authorized to install the listed item. The maintenance level codes are:

<i>code</i>	<i>Explanation</i>
C_ _ _ _ _	-Operator/crew
O- - - - -	-Organizational maintenance
F_ _ _ _ _	-Direct support maintenance
H_ _ _ _ _	-General support maintenance
D_ _ _ _ _	-Depot maintenance

(3) Recoverability code indicates whether unserviceable items should be returned for recovery or salvage. Items not coded are expendable. Recoverability codes are:

<i>code</i>	<i>Explanation</i>
R--	Repair parts and assemblies that are economically repairable at DSU and GSU activities and normally are furnished by supply on an exchange basis.
S-	Repair parts and assemblies which are economically repairable at DSU and GSU activities and which normally are furnished by supply on an exchange basis. When items are determined by a GSU to be uneconomically repairable, they will be evacuated to a depot for evaluation and analysis before final disposition.
T-	High dollar value recoverable repair parts which are subject to special handling and are issued on an exchange basis. Such repair parts normally are repaired or overhauled at depot maintenance activities.
U-	Repair parts specifically selected for salvage by reclamation units because of precious metal content, critical materials, or high dollar value reusable castings or castings.

**b. Federal Stock Number.** Indicates the Federal stock number assigned to the item and will be used for requisitioning purposes.

**c. Description.** Indicates the Federal item name and any additional description of the item required. A part number or other reference number is *followed* by the applicable five-digit Federal supply code for manufacturers in parentheses.

**d. Unit of Measure (U/M).** A two-character alphabetic abbreviation indicating the amount or quantity of the item upon which the allowances are based, e.g., ft, pr, ea, etc.

**e. Quantity Incorporated in Unit.** Indicates the quantity of the item used in the assembly group. Subsequent appearances of the same item in the same assembly are indicated by the letters "REF". A "V" appearing in this column in lieu of a quantity indicates that a definite quantity cannot be indicated (e.g., shims, spacers, etc).

**f. Allowances (15-Day Organizational Maintenance, 30-Day DS/GS Maintenance, 1 Year Per Equipment (Contingency), and Depot Maintenance.** Items authorized for requisition as required are identified by an asterisk in the allowances column.

**g. Illustration**

(1) **Figure number.** Indicates the figure number of the illustration in which the item is shown.

(2) **Item number or reference designation.** Indicates the reference designation used to identify the item in the illustration.

**1-4. Special Information**

The following publication pertains to the KWT-6 Type 8 and its components:

TM 11-5820-555-15      Organizational, DS, GS,  
and Depot Maintenance Manual;  
Transceiver KWT-6  
Type 8.

**1-5. Location of Repair Parts**

a. This manual contains two cross-reference indexes (sec IV and sec V) to be used to locate a repair part when either the Federal stock number, reference number (manufacturer's part number), or reference designation is known. The first column in each index is prepared in numerical or alpha-numeric sequence in ascending order. When a Federal stock number is not listed or not known refer to the reference number (manufacturer's Part

number) immediately following the last listed Federal stock number.

b. When the Federal stock number or reference number is known, follow the procedures given in (1) and (2) below.

(1) Refer to the index of Federal stock numbers and reference numbers (sec IV) and locate the Federal stock number or reference number. The Federal stock number and reference numbers are cross-referenced to the applicable figure and reference designation.

(2) When the reference designation is determined, refer to the reference designation index (sec V). The reference designations are listed in ascending order and are cross-referenced to the page number on which they appear in the repair parts lists (sec II and IIF). Refer to the page number noted in the index and locate the reference designation in the repair parts list.

c. When the reference designation is known, follow the procedures given in b(2) above.

d. When neither the FSN, reference number, nor reference designation is known, identify the part in the illustration and follow directions given in c above; or scrutinize column 3 of the repair parts lists (sec II and sec III).

### 1-6. Federal Supply Code for Manufactures

<i>Code</i>	<i>Manufacturer</i>
00213	Sage Electronics Corp.
00656	Aervox Corp.
00779	AMP, Inc.
00121	Allen-Bradley Co.
01146	Harris Mfg. Co.
01281	TRW Inc. Semiconductor Division
01526	General Electric Co. Communication and Control Devices Dept.
01634	Aluminum Co. of America
01686	RCL Electronics, Inc.
01881	Anaconda American Brass Co.
01939	Sprague Electric Co. of Wisconsin
02114	Ferroxcube Corp.
02660	Bunker-Ramo Corp. The Amphenol Connector Div.
03497	General Electric Co. Low-Voltage Switchgear Dept.
03890	Markel L Frank and Sons
04009	Arrow-Hart, Inc.
04221	Aemco Division of Midtex, Inc.
04740	Duramark, Inc.
04796	Sequoia Wire Co.
05284	Gasket Engineering Co., Inc.
05411	DuPage Mfg. Co.
05657	Corbin Hose Clamp Division of Emhart Corp.
05973	Haveg Industries, Inc. Super Temp Wire Div.
06090	Raychem Corp.
06978	Aladdin Electronics Division of Aladdin Industries, Inc.
06980	Varian Eimac Division
07263	Fairchild Semiconductor A Division of Fairchild Camera and Instrument Corp.
07688	Joint Electron Device Engineering Council
07886	National Radio Co., Inc. Commercial Products Division
08289	Blinn Delbert Co., Inc., The
08664	Bristol Co. Division of American Chain and Cable Co., Inc.
08795	Rayclad Tubes, Inc.
08805	General Electric Co. Large Lamp Dept.
09250	Electro Assemblies, Inc.
09922	Burndy Corp.
10583	Columbia Technical Corp. Industrial MICA Division
10646	Carborundum Co., The
12014	Chicago Rivet and Machine Co.
12615	U.S. Terminals, Inc.
12998	Quality Name Plate, Inc.
13499	Collins Radio Co.
14018	Anaconda Wire and Cable Co.
14655	Cornell-Dubilier Electric Corp. Division Federal Pacific Electric co.
14674	Corning Glass Works
17264	Mid-States Screw Corp.
19500	Edison, Thomas A. Industries Division of McGraw-Edison, NJ.
19701	Electro/Midland Corp.
19728	Prestolite Co., Inc. Division of Eltra Corp.
20254	Coilform Co., Inc.
21537	Screw Craft Products
24817	Gibson Electric Co.
2514	Globe Industries Division of TRW, Inc.
25472	Goodrich, B. F. Co., The
37942	Mallory P. R. and Co., Inc.
40920	Miniature Bearing Division MPB Corp.
42489	National Chair Co.
43334	New Departure-Hyatt

Code	Manufacturer	Code	Manufacturer
	Bearings Division		Electron Dynamics Division
	General Motors Corp.	<b>78386</b> -----	Freed Transformer Co., Inc.
<b>44038</b> ----	North Electric Co.	<b>73831</b> -----	Hammond Mfg. Co., Ltd:
<b>44655</b> ----	Ohmite Mfg. Co.	<b>73899</b> -----	J.F.D. Electronics Co.
<b>46722</b> - - -	-Parker-Kalon Corp.	<b>73949</b> -----	Guardian Electric Mfg. Co,
<b>46384</b> ----	Penn Engineering and Mfg. Corp.	<b>73957</b> ----	Groov-Pin Corp.
<b>49671</b> ----	Radio Corp. of America	<b>74048</b> ----	Meyercord Co.
<b>49956</b> ---	Raytheon Co.	74116----	New England Electric Wire Corp.
53021-----	Sangamo Electric Co.	<b>74217</b> ----	Radio Switch Corp.
<b>54715</b> -----	Shure Bros. Inc.	<b>74868</b> -----	Bunkerramo Corp., The
<b>54753</b> -----	General Instrument Corp.		Amphenol RF Division
	Sickles F. W. Division	74921----	Iten Fibre Co., The
56289----	Sprague Electric Co.	<b>74970</b> ----	Johnson, E. F. Co.
<b>56878</b> - - -	-Standard Pressed Steel Co.	<b>75037</b> ----	Minnesota Mining and Mfg. Co.
<b>57771</b> ----	Stimpson Edwin B. Co., Inc.		Electra Products Div.
<b>59730</b> -----	Thomas and Betts Co., The	75183----	Johnson Rubber Co., The
<b>60380</b> -----	Torrington Co., The	<b>75376</b> -----	Kurz-Kasch, Inc.
	Subsidiary of Ingersoll-Rand Corp.	<b>75382</b> ----	Kulka Electric Corp.
61463----	United States Rubber Co.	<b>75543</b> ----	Lavelle Rubber Co.
61864-----	United-Carr Inc.	75618_____	Lion Fastener Co. Inc.
61957---	USM Corp.	75818-----	Lenz Electric Mfg. Co.
70371----	American Lava Corp.	75915-----	Littlefuse, Inc.,
70417---	Chrysler Corp.	<b>76005</b> -----	Lord Mfg. Co.
	Amplex Division		Division of Lord Corp.
<b>70567</b> -----	Anaconda Co.	<b>76487</b> ----	Millen James Mfg. Co., Inc.
70601-----	Anti-Corrosive Metal Products Co.,	<b>76854</b> -----	Oak Mfg. Co.
	Inc.		Division of Oak Electro/Netics
<b>70674</b> ---	ADC Products		Corp.
	Division of Magnetic Controls Co.	<b>77147</b> ----	Patton Mac-Guyer Co.
71034-----	Bliley Electric Co.		Division of Avid Corp.
<b>71279</b> -----	Cambridge Thermionic Corp.	<b>77250</b> -----	Pheoll Mfg. Co.
71286_____	Rex Chainbelt, Inc.		Division of Allied Products Corp.
	Camloc Division	77342_____	AMF, Inc.
71400-----	Bussmann Mfg.		Potter and Brumfield Division
	Division of McGraw-Edison Co.	78189_____	Illinois Tool Work's, Inc.
71450---	CTS Corp.		Shakeproof Division
71468---	ITT Cannon Electric Inc.	<b>78277</b> -----	Sigma Instruments, Inc.
71590-----	Globe Union, Inc.	<b>78488</b> -----	Stackpole Carbon Co.
	Centralab Division	<b>78553</b> _____	Tinnerman Products, Inc.
<b>71628</b> -----	Phelps Dodge Communications Co.	79136-----	Waldes Kohinoor, Inc.
	Division of Phelps Dodge Copper	79251-----	Wenco Mfg. Co.
	Products	79515-----	Wheaton, Inc.
71785_____	Cinch Mfg. Co.	79807_____	Wrought Washer Mfg. Co.
	Division of TRW Inc.	79963-----	Zierick Mfg. Co.
71984----	Dow Corning Corp.	<b>80008</b> _____	Electro Engineering Works, Inc.
72136-----	Electro Motive Mfg. Co. Inc., The	<b>80033</b> ----	Prestole Everlock, Inc.
72512____	--Davies, Harry Molding Co.	<b>80058</b> -----	Joint Electronic Type Designation
72619-----	Dialight Corp.		System
<b>72765</b> -----	Drake Mfg. Co.	80079-----	Communication Products Co.
72914_____	Grimes Mfg. Co.	80089-----	Essex Wire Corp.
<b>72962</b> -----	Elastic Stop Nut		Controls Division
	Division of Amerace Esna Corp.	<b>80223</b> -----	United Transformer Co.
<b>72982</b> -----	Erie Technological Products Inc.	<b>80294</b> -----	Bourns, Inc.
<b>73168</b> -----	Fenwal, Inc.	80331-----	Utah-American Corp.
73293-----	Hughes Aircraft Co.	<b>80368</b> -----	Sylvania Electric Products, Inc.



<i>Code</i>	<i>Manufacturer</i>
<b>80483</b> -----	<b>Aladdin Industries, Inc.</b>
<b>80583</b> -----	<b>Hammorlund Mfg. Co., Inc., The</b>
<b>80694</b> -----	<b>Forest Electric Co.</b>
<b>81030</b> -----	<b>International Instruments, Inc.</b>
	<b>Division Sigma Instruments, Inc.</b>
<b>81312</b> -----	<b>Winchester Electronics</b>
	<b>Division Litton Industries, Inc.</b>
<b>81349</b> -----	<b>Military Specifications</b>
<b>81350</b> -----	<b>Joint Army-Navy Specifications</b>
81554-----	Anaconda Wire and Cable Co.
81640----	Controls Co. of America
	Control Switch Division
81815-----	Communication Coil Co.
81861 ____	Bently Harris Mfg. Co.
82068-----	Burnell-Nytronics
82096---	General Television and Radio Corp.
82110 ____	Gudebrod Bros. Silk Co. Inc.
82142-----	Airco Speer Electronics
	Div. of Air Reduction Co., Inc.
82219-----	Sylvania Electric Products, Inc.
	Electronic Tube Div.
	Receiving Tube Operations
82386-----	Sun Electric Corp.
82872---	Roanwell Corp.
82877-----	Rotron, Inc.
83014-----	Hartwell Corp.
83086-----	New Hampshire Ball Bearings, Inc.
83722 ____	Paul and Beekman, Inc.
83827-----	Resistors, Inc.
86684----	Radio Corp. of America
	Electronic Components
88044-----	Aeronautical Standards
88245-----	Litton Precision Products, Inc.
	Useco Div. Litton Industries
<b>88252</b> -----	<b>NAPCO Chemical Co.</b>
<b>88797</b> -----	<b>Robintech, Inc.</b>
	<b>Electro Mechanical Div.</b>
<b>89185</b> -----	<b>Aeronautical Radio, Inc.</b>
<b>90030</b> -----	<b>USM Corp.</b>
	<b>USM Machinery Div.</b>
<b>90484</b> -----	<b>ITT</b>
	<b>Surprenant Div.</b>

<i>Code</i>	<i>Manufacturer</i>
91314____	Lewis Spring and Mfg. Co.
91500-----	Asheville-Schoonmaker Mica Co.
91637----	Dale Electronics, Inc.
91662-----	Elco Corp.
91663-----	Armel Electronics, Inc.
91929 ____	Honeywell, Inc.
	Microswitch Div.
92064----	Radio Cores, Inc.
92825 -----	Whitso, Inc.
93929-----	GV Controls, Inc.
94151-----	Sylvania Electric Products, Inc.
	Electronic Tube Division
	Picture Tube Operations
94375----	Automatic Metal Products Corp.
94991 ____	Sylvania Electric Products, Inc.
	Wire, Metal and Plastic Parts Div.
95088____	Transonic, Inc.
95238-----	Continental Connector Corp.
96214 ____	Texas Instruments, Inc.
	Government Products Div. of
	Equipment Group
96906-----	Military Standards
97315-----	Ballastran Corp.
97814-----	Sealtron Co.
98291-----	Seaelectro Corp.
99378-----	Atlee Corp.
99800-----	Delevan Division
	American Precision Industries,
	Inc.

### 1-7. Reporting of Equipment Publication Improvements

The reporting of errors, omissions, and recommendations for improving this publication by the individual user is encouraged. Reports should be submitted on DA Form 2028 (Recommended Changes to Publications) and forwarded direct to Commander, US Army Electronic Command, ATTN: AMSEL-MA-CT, Fort Monmouth, NJ 07703.

SECTION II REPAIR PARTS FOR ORGANIZATIONAL MAINTENANCE

(1) SIB CODE	(2) FEDERAL STOCK NUMBER	(3) DESCRIPTION	(4) UNIT OF MEAS	(5) QTY INC IN UNIT	(6) 15-DAY ORGANIZATIONAL MAINTENANCE ALW				(7) ILLUSTRATIONS	
					(a) 1-5	(b) 6-20	(c) 21-50	(d) 51-100	(a) FIG NO.	(b) ITEM NO. OR REFERENCE DESIGNATION
		Reference Number & Mfr Code								
A-O-R		TRANSMITTER KW16-8 (THIS ITEM IS NONREPAIRABLE)  TRANSMITTER 522-2052-011 (13499)  GROUP 01- FREQUENCY GENERATOR 786-1	EA	1						1
A-O-R		FREQUENCY GENERATOR 522-0860-013 (13499)	EA	1					3-1	1A4
A-O-R		GENERATOR, FREQUENCY 542-7787-000 (13499)	EA	1						
P-O	6240-155-7836	LAMP, INCANDESCENT MS25237-327 (96906)	EA	4	*	*	*	*	3-3	1A4DS1
P-O	6240-155-7836	LAMP, INCANDESCENT MS25237-327 (96906)	EA	REF	*	*	*	*	3-3	1A4DS2
P-O	6240-155-7836	LAMP, INCANDESCENT MS25237-327 (96906)	EA	REF	*	*	*	*		1A4DS3
P-O	6240-155-7836	LAMP, INCANDESCENT MS25237-327 (96906)	EA	REF	*	*	*	*		1A4DS4
P-O	6210-813-2725	LIGHT, INDICATOR A9849-1 (72914)	EA	4	*	*	*	*	3-3	1A4XDS1
P-O	6210-813-2725	LIGHT, INDICATOR A9849-1 (72914)	EA	REF	*	*	*	*	3-3	1A4XDS2
P-O	6210-813-2725	LIGHT, INDICATOR A9849-1 (72914)	EA	REF	*	*	*	*		1A4XDS3
P-O	6210-813-2725	LIGHT, INDICATOR A9849-1 (72914)	EA	REF	*	*	*	*		1A4XDS4
P-O	5355-817-5564	KNOB 116-217 (74970)	EA	1	*	*	*	*	3-3	1A401
P-O	5355-821-5824	KNOB 116-260 (74970)	EA	1	*	*	*	*	3-3	1A402
P-O	5310-054-1830	WASHER, LOCK ME35338-80 (96906)	EA	50	*	*	*	*		
P-O	5120-813-0232	WRENCH 544-6032-002 (13499)	EA	1	*	*	*	*		
XI-O		KEY, SOCKET HEAD SCREW B096 (08664)	EA	1						
XI-O		SHAFT, WRENCH 505-3800-002 (13499)	EA	1						
XI-O		HANDLE, WRENCH 544-6033-002 (13499)	EA	1						
A-O-R		STABILIZED OSCILLATOR 528-0176-005 (13499)	EA	1						
P-O	5960-045-8639	ELECTRON TUBE 5654 (89185)	EA	2	*	*	*	*	3-6	1A4A3V1
P-O	5960-045-8639	ELECTRON TUBE 5654 (89185)	EA	REF	*	*	*	*	3-6	1A4A3V3
P-O	5960-262-3002	ELECTRON TUBE 5750 (89185)	EA	1	*	*	*	*	3-6	1A4A3V2
P-O	5960-188-6584	ELECTRON TUBE 5670 (89185)	EA	1	*	*	*	*	3-6	1A4A3V4
A-O-R		TUNER, RADIO FREQUENCY 546-2148-005 (13499)	EA	1					3-4	1A4A4
P-O	5960-262-0210	ELECTRON TUBE 5814A (89185)	EA	2	*	*	*	*	3-16	1A4A4V1

SECTION II REPAIR PARTS FOR ORGANIZATIONAL MAINTENANCE (CONTINUED)

(1) SIB CODE	(2) FEDERAL STOCK NUMBER	(3) DESCRIPTION  USABLE ON CODE	(4) UNIT OF MEAS	(5) QTY INC IN UNIT	(6) 15-DAY ORGANIZATIONAL MAINTENANCE ALW				(7) ILLUSTRATIONS	
					(a) 1-5	(b) 6-20	(c) 21-50	(d) 51-100	(a) FIG NO.	(b) ITEM NO. OR REFERENCE DESIGNATION
					Reference Number & Mfr Code					
P-O	5960-262-0210	ELECTRON TUBE 5814A (89185)	EA	REF	*	*	*	*	3-16	1A2A4V3
P-O	5960-134-6004	ELECTRON TUBE 5749 (89185)	EA	6	*	*	*	*	3-16	1A2A4V2
P-O	5960-134-6004	ELECTRON TUBE 5749 (89185)	EA	REF	*	*	*	*	3-16	1A2A4V4
P-O	5960-134-6004	ELECTRON TUBE 5749 (89185)	EA	REF	*	*	*	*	3-16	1A2A4V5
P-O	5960-134-6004	ELECTRON TUBE 5749 (89185)	EA	REF	*	*	*	*	3-16	1A2A4V7
P-O	5960-134-6004	ELECTRON TUBE 5749 (89185)	EA	REF	*	*	*	*	3-16	1A2A4V8
P-O	5960-134-6004	ELECTRON TUBE 5749 (89185)	EA	REF	*	*	*	*	3-16	1A2A4V10
P-O	5960-134-0243	ELECTRON TUBE 6C16 (49671)	EA	1	*	*	*	*	3-16	1A2A4V6
P-O	5960-045-8639	ELECTRON TUBE 5654 (89185)	EA	1	*	*	*	*	3-16	1A2A4V9
P-O		KIT, MOUNTING 541-1477-002 (13499)	EA	9	*	*	*	*		
P-O	5310-054-1830	WASHER, LOCK MS35338-80 (96906)	EA	REF	*	*	*	*		
P-O		WASHER, FLAT 310-0167-000 (79807)	EA	72	*	*	*	*		
P-O		WASHER, LOCK 310-0286-000 (13499)	EA	76	*	*	*	*		
P-O	5305-579-3507	SCREW, MACHINE MS35216-40 (96906)	EA	30	*	*	*	*		
P-O		SCREW, MACHINE P343-0247-000 (77250)	EA	72	*	*	*	*		
		GROUP 02 - SIDEBAND GENERATOR 786F-1								
A-O-R		SIDEBAND GENERATOR 786F-1 522-0861-034 (13499)	EA	1					3-1	1A5
P-O	5960-262-0210	ELECTRON TUBE 5814A (89185)	EA	1	*	*	*	*	3-21	1A5A7V1
P-O		KIT, MOUNTING 541-1477-002 (13499)	EA	REF	*	*	*	*		
P-O	5310-054-1830	WASHER, LOCK MS35338-80 (96906)	EA	REF	*	*	*	*		
P-O		WASHER, FLAT 310-0167-000 (79807)	EA	REF	*	*	*	*		
P-O		WASHER, LOCK 310-0286-000 (13499)	EA	REF	*	*	*	*		
P-O	5305-579-3507	SCREW, MACHINE MS35216-40 (96906)	EA	REF	*	*	*	*		
P-O		SCREW, MACHINE P343-0247-000 (77250)	EA	REF	*	*	*	*		
		GROUP 03 - POWER SUPPLY PP-2154/U								
A-O-R		POWER SUPPLY, LOW VOLTAGE PP-2154/U 522-0862-003 (13499)	EA	1					3-1	1A10
A-O		PANEL, POWER DISTRIBUTOR 542-7405-005 (13499)	EA	1						

SECTION II REPAIR PARTS FOR ORGANIZATIONAL MAINTENANCE (CONTINUED)

(1) SNR CODE	(2) FEDERAL STOCK NUMBER	(3) DESCRIPTION	(4) UNIT OF MEAS	(5) QTY INC IN UNIT	(6) 15-DAY ORGANIZATIONAL MAINTENANCE ALW				(7) ILLUSTRATIONS		
					USABLE ON CODE	(a)	(b)	(c)	(d)	(a) FIG NO.	(b) ITEM NO. OR REFERENCE DESIGNATION
						1-5	6-20	21-50	51-100		
P-0	6240-155-8706	LAMP, INCANDESCENT MS15571-2 (96906)	EA	1	*	*	*	*	3-33	1A1011	
P-0	5210-067-8381	LIGHT, INDICATOR 81410-1PC (72619)	EA	1	*	*	*	*	3-33	1A10X11	
P-0	5210-583-9437	LENS, INDICATOR LIGHT 25-100RED (72765)	EA	1	*	*	*	*	3-33	1A10DS1	
P-0	5920-518-1796	FUSE, CARTRIDGE FO2A250V3AS (81349)	EA	1	*	*	*	*	3-33	1A10F1	
P-0	5310-054-1830	WASHER, LOCK MS35338-80 (96906)	EA	REF	*	*	*	*			
P-0		KIT, MOUNTING 024-0100-000 (13499)	EA	REF	*	*	*	*			
P-0	5310-054-1830	WASHER, LOCK MS35338-80 (96906)	EA	REF	*	*	*	*			
P-0		WASHER, FLAT 310-0167-000 (79807)	EA	REF	*	*	*	*			
P-0		WASHER, LOCK 310-0286-000 (13499)	EA	REF	*	*	*	*			
P-0	5305-579-3507	SCREW, MACHINE MS35216-40 (96906)	EA	REF	*	*	*	*			
P-0		SCREW, MACHINE P343-0247-000 (77250)	EA	REF	*	*	*	*			
GROUP 04 - POWER SUPPLY PP-2153/U											
A-O-R		POWER SUPPLY PP-2153/U 522-0863-006 (13499)	EA	1					3-1	1A12	
P-0	5920-636-0957	FUSE, CARTRIDGE F60C500V1A (81349)	EA	1	*	*	*	*	3-35	1A12F3	
P-0	5240-143-3060	LAMP, INCANDESCENT MS15567-1 (96906)	EA	1	*	*	*	*	3-35	1A12DS1	
P-0	6210-061-2633	LENS, INCANDESCENT LIGHT 51-111 (72619)	EA	1	*	*	*	*		1A12DS2	
A-0		POWER SUPPLY SUBASSEMBLY 543-466-004 (13499)	EA	1							
P-0	5920-669-6859	FUSE, CARTRIDGE FO2B250V3-8AS (81349)	EA	1	*	*	*	*		1A12F2	
A-0		KIT, FUSE 543-1441-000 (13499)	EA	1							
M-0		ENVELOPE, PACKAGING 025-0001-000 (13499)	EA	4							
P-0	5920-519-7733	FUSE, CARTRIDGE FO3A250V8AS (81349)	EA	1	*	*	*	*	3-35	1A12F1	
P-0	5920-243-3788	FUSE, CARTRIDGE FO3A250V15AS (81349)	EA	1	*	*	*	*	3-35	1A12F1	
P-0		KIT, MOUNTING 541-1477-002 (13499)	EA	REF	*	*	*	*			
P-0	5310-054-1830	WASHER, LOCK MS35338-80 (96906)	EA	REF	*	*	*	*			
P-0		WASHER, FLAT 310-0167-000 (79807)	EA	REF	*	*	*	*			
P-0		WASHER, LOCK 310-0286-000 (13499)	EA	REF	*	*	*	*			
P-0	5305-579-3507	SCREW, MACHINE MS35216-40 (96906)	EA	REF	*	*	*	*			

SECTION II REPAIR PARTS FOR ORGANIZATIONAL MAINTENANCE (CONTINUED)

FEDERAL STOCK NUMBER	DESCRIPTION	USABLE ON CODE	UNIT OF MEAS	QTY INC IN UNIT	15-DAY ORGANIZATIONAL MAINTENANCE ALLOW				FIG NO.	ILLUSTRATIONS (b) ITEM NO. OR REFERENCE DESIGNATION
					(a)	(b)	(c)	(d)		
					1-5	6-20	21-50	51-100		
	Reference Number & Mfr Code									
P-O	SCREW, MACHINE F343-0247-000 (77250)		EA	REF	*	*	*	*		
	GROUP 05 - AMPLIFIER, POWER 367A-3									
A-O-R	AMPLIFIER, POWER 367A-3 522-0864-000 (13499)		EA	1					3-1 1A3	
P-O	5355-814-8340 KNOB 542-7447-003 (13499)		EA	1	*	*	*	*	1A301	
P-O	5355-774-5221 KNOB, DIAL COUNTER 542-7411-002 (13499)		EA	3	*	*	*	*		
P-O	5820-936-8378 JIG, ADJUSTING 547-9149-002 (13499)		EA	5	*	*	*	*		
M-C	ENVELOPE, PACKAGING 025-0001-000 (13499)		EA	REF						
A-O	PANEL, POWER 543-0421-004 (13499)		EA	1						
P-O	6240-223-9100 LAMP, GLOW ME51 (08805)		EA	1	*	*	*	*	3-36 1A303	
P-O	6210-299-3025 LENS, INDICATOR 52-991 (72619)		EA	1	*	*	*	*	1A304	
P-O	5355-668-3295 KNOB-BAR 508-1103-200 (13499)		EA	2	*	*	*	*		
A-O	KIT, FUSE 543-0301-000 (13499)		EA	1						
M-O	ENVELOPE, PACKAGING 025-0001-000 (13499)		EA	REF						
P-O	5920-281-0224 FUSE, CARTRIDGE FO2A250V1-2AS (81349)		EA	1	*	*	*	*	3-36 1A301	
P-O	5920-280-4465 FUSE, CARTRIDGE FO2A250V1AS (81349)		EA	1	*	*	*	*	3-36 1A302	
P-O	5355-668-3295 KNOB-BAR 508-1103-200 (13499)		EA	REF	*	*	*	*		
A-O	AMPLIFIER SUBASSEMBLY 543-0300-000 (13499)		EA	1						
P-O	5960-615-0243 ELECTRON TUBE 6CL6 (86684)		EA	2	*	*	*	*	3-37 1A301	
P-O	5960-615-0243 ELECTRON TUBE 6CL6 (86684)		EA	REF	*	*	*	*	3-37 1A302	
P-O	KIT, MOUNTING 541-1477-002 (13499)		EA	REF	*	*	*	*		
P-O	5310-054-1830 WASHER, LOCK MS35338-80 (96906)		EA	REF	*	*	*	*		
P-O	WASHER, FLAT 310-0167-000 (79807)		EA	REF	*	*	*	*		
P-O	WASHER, LOCK 310-0286-000 (13499)		EA	REF	*	*	*	*		
P-O	5305-579-3507 SCREW, MACHINE MS35216-40 (96906)		EA	REF	*	*	*	*		
P-O	SCREW, MACHINE F343-0247-000 (77250)		EA	REF	*	*	*	*		
P-O	5310-054-1830 WASHER, LOCK MS35338-80 (96906)		EA	REF	*	*	*	*		
P-O	5305-054-5635 SCREW, MACHINE MS51957-1 (96906)		EA	REF	*	*	*	*		

SECTION II REPAIR PARTS FOR ORGANIZATIONAL MAINTENANCE (CONTINUED)

(1) SHR CODE	(2) FEDERAL STOCK NUMBER	(3) DESCRIPTION	(4) USABLE ON CODE	(5) QTY INC IN UNIT	(6) 15-DAY ORGANIZATIONAL MAINTENANCE ALLOW				(7) ILLUSTRATIONS	
					(a) 1-5	(b) 6-20	(c) 21-50	(d) 51-100	(a) FIG NO.	(b) ITEM NO. OR REFERENCE DESIGNATION
		GROUP 06 - AUDIO CONTROL UNIT 159B-1								
A-0		AUDIO CONTROL UNIT 159B-1 522-0963-000 (13499)		EA 1					3-1	1A7
A-0		AUDIO CONTROL UNIT SUBASSEMBLY 543-3046-000 (13499)		EA 1						
A-0		AMPLIFIER 522-0388-003 (13499)		EA 1					3-39	1A7A4
P-0	5920-280-4465	FUSE, CARTRIDGE FO2A250V1AS (81349)		EA 1	*	*	*	*	3-44	1A7A4F201
P-0		SCREW, TAPPING, TILthead 2X1-GRANEDTYPBGAFL (14722)		EA REF	*	*	*	*		
P-0	5305-054-5635	SCREW, MACHINE MS51957-1 (96906)		EA REF	*	*	*	*		
P-0		KIT, MOUNTING 541-1477-002 (13499)		EA REF	*	*	*	*		
P-0	5310-054-1830	WASHER, LOCK MS35338-80 (96906)		EA REF	*	*	*	*		
P-0		WASHER, FLAT 310-0167-000 (79807)		EA REF	*	*	*	*		
P-0		WASHER, LOCK 310-0286-000 (13499)		EA REF	*	*	*	*		
P-0	5305-579-3507	SCREW, MACHINE 310-0286-C30 (13499)		EA REF	*	*	*	*		
P-0		SCREW, MACHINE P343-0247-000 (77250)		EA REF	*	*	*	*		
XI-0		PLATE, SLIDING MS21044D06 (96906)		EA REF						
		GROUP 07 - COOLER, AIR, ELECTRICAL EQUIPMENT HD-347/U								
A-0-R		COOLER, AIR, ELECTRICAL EQUIPMENT HD-347/U 522-0983-005 (13499)		EA 1					3-1	1A11
P-0		KIT, FUSE 543-3409-000 (13499)		EA 1	*	*	*	*	3-46	1A11F1
M-0		ENVELOPE, PACKAGING 025-0001-000 (13499)		EA REF						
P-0	5920-855-4260	FUSE, CARTRIDGE FO2B125V2AS (81349)		EA 1	*	*	*	*		
P-0	5920-850-6091	FUSE, CARTRIDGE FO2B250V1AS (81349)		EA 1	*	*	*	*		
XI-0		PLATE, SHORTING 543-3410-002 (13499)		EA 1						
XI-0		PLATE, SHORTING 543-3411-002 (13499)		EA 1						
P-0		KIT, MOUNTING 541-1477-002 (13499)		EA REF	*	*	*	*		
P-0	5310-054-1830	WASHER, LOCK MS35338-80 (96906)		EA REF	*	*	*	*		
P-0		WASHER, FLAT 310-0167-000 (79807)		EA REF	*	*	*	*		
P-0		WASHER, LOCK 310-0286-000 (13499)		EA REF	*	*	*	*		
P-0	5305-579-3507	SCREW, MACHINE MS35216-40 (96906)		EA REF	*	*	*	*		
P-0		SCREW, MACHINE P343-0247-000 (77250)		EA REF	*	*	*	*		

SECTION II REPAIR PARTS FOR ORGANIZATIONAL MAINTENANCE (CONTINUED)

(1) SNR CODE	(2) FEDERAL STOCK NUMBER	(3) DESCRIPTION	(4) USABLE ON CODE	(8) KIT OR MEAS	(5) QTY INC IN UNIT	(6) 15-DAY ORGANIZATIONAL MAINTENANCE ALW				(7) ILLUSTRATIONS	
						(a) 1-5	(b) 6-20	(c) 21-50	(d) 51-100	(a) FIG NO.	(b) ITEM NO. OR REFERENCE DESIGNATION
		Reference Number & W/r Code									
		GROUP 08 - COMPARATOR ASSEMBLY CW-126/UR									
		COMPARATOR ASSEMBLY CW-126/UR 522-1074-000 (13499)		EA	1					3-1	1A8
P-O	5960-792-7432	ELECTRON, TUBE 32B2WA (49671)		EA	1	*	*	*	*	3-47	1A8V1
P-O	5960-556-1332	ELECTRON TUBE 6BB6 (49671)		EA	1	*	*	*	*	3-47	1A8V2
A-O		PLATE ASSEMBLY 543-4351-000 (13499)		EA	1						
		GROUP 09 - INTERCONNECTING BOX 153H-3									
A-O-R		INTERCONNECTING BOX 153H-3 522-2363-005 (13499)		EA	1					3-1	1A1
A-O		RELAY, THERMAL-RECEIVER 547-1324-000 (13499)		EA	1						
P-O	5240-179-1811	LAMP, GLOW NE2 (08805)		EA	1	*	*	*	*	3-49	1A1DS2
P-O	5210-688-5543	LENS, INDICATOR LIGHT 8L-111PC (72619)		EA	1	*	*	*	*		1A1E1
P-O	6240-155-8714	LAMP, INCANDESCENT MS15571-4 (96906)		EA	1	*	*	*	*	3-49	1A1DS1
		GROUP 10 - HANDSET ADAPTOR ASSEMBLY C2691/URC									
A-O-R		HANDSET ADAPTER ASSEMBLY C2691/URC 543-6094-000 (13499)		EA	1					3-1	1A9
A-O		PLATE ASSEMBLY 543-6099-000 (13499)		EA	1						
P-O		SCREW, TAPPING, THREAD 2X1-8PANHDTYPECADPL (45722)		EA	REF	*	*	*	*		
		GROUP 11 - UNIT ASSEMBLY CW AND FSK CW-730/URCtext									
A-O-R		UNIT ASSEMBLY - CW and FSK CW-730/URC 543-8129-000 (13499)		EA	1					3-1	1A6
P-O	6240-155-8706	LAMP, INCANDESCENT MS15571-2 (96906)		EA	1	*	*	*	*	3-52	1A6DS2
P-O	6240-155-8714	LAMP, INCANDESCENT MS15571-4 (96906)		EA	1	*	*	*	*	3-52	1A6DS1
P-O	6210-583-9437	LENS, INDICATOR LIGHT 25-100RED (72756)		EA	1	*	*	*	*		1A6DS3
P-O	5960-636-2218	ELECTRON, TUBE 12AU7 (49671)		EA	1	*	*	*	*	3-53	1A6V2
P-O	5960-846-6619	ELECTRON, TUBE 12AT7 (49671)		EA	1	*	*	*	*	3-53	1A6V1
P-O		KIT, MOUNTING 543-2477-002 (13499)		EA	REF	*	*	*	*		
P-O	5310-054-1830	WASHER, LOCK MS35338-80 (96906)		EA	REF	*	*	*	*		
P-O		WASHER, FLAT 310-0167-000 (79807)		EA	REF	*	*	*	*		
P-O		WASHER, LOCK 310-0286-000 (13499)		EA	REF	*	*	*	*		
P-O	5305-579-3507	SCREW, MACHINE MS35216-40 (96906)		EA	REF	*	*	*	*		

SECTION II REPAIR PARTS FOR ORGANIZATIONAL MAINTENANCE (CONTINUED)

(1) SAR CODE	(2) FEDERAL STOCK NUMBER	(3) DESCRIPTION	USABLE ON CODE	(4) UNIT OF MEAS	(5) QTY INC IN UNIT	(6) 15-DAY ORGANIZATIONAL MAINTENANCE ALW				(7) ILLUSTRATIONS	
						(a) 1-5	(b) 6-20	(c) 21-50	(d) 51-100	(a) FIG NO.	(b) ITEM NO. OR REFERENCE DESIGNATION
P-0		SCREW, MACHINE P343-0247-003 (77250)		EA	REF	*	*	*	*		
		GROUP 12 - BACK, ELECTRICAL EQUIPMENT MT-2251/U									
P-0	5920-686-0025	FUSE, CARTRIDGE F60C500V20A (81349)		EA	2	*	*	*	*		1A13F1
P-0	5920-686-0025	FUSE, CARTRIDGE F60C500V20A (81349)		EA	REF	*	*	*	*		1A13F2
A-0-R		HANDSET, H-169/U H169U (80058)		EA	1						
P-0		HANDSET CASE 65B762A (54715)		EA	1	*	*	*	*		
		GROUP 13 - DUMMY LOAD ELECTRICAL 172I-1									
A-0-R		DUMMY LOAD, ELECTRICAL 172J-1 522-1741-000 (13499)		EA	1						1A14
		GROUP 14 - NETWORK, ANTENNA 1800-2									
A-0-R		NETWORK, ANTENNA 180U-2 522-1398-000 (13499)		EA	1					3-1	1A2
X1-0		PANEL, MOUNTING 544-7216-004 (13499)		EA	1						
X2-0		BOX, SPEAKER 544-7215-004 (13499)		EA	1						
X1-0		BOX, SPEAKER 544-7214-004 (13499)		EA	1						
P-0	5310-918-7213	NUT, CAPTIVE NCM4-2-2-1 (07886)		EA	REF	*	*	*	*		
P-0		NUT, CAPTIVE NCM6-2-2-1 (07886)		EA	REF	*	*	*	*		
X2-0		PANEL, FRONT 544-7212-003 (13499)		EA	1						
X2-0		PLATE, SWITCH 544-7207-003 (13499)		EA	1						
X2-0		COVER, PRESSED LEFT 544-7210-002 (13499)		EA	1						
X2-0		COVER, WELDED 544-7209-002 (13499)		EA	1						
P-0	5310-918-7213	NUT, CAPTIVE NCM4-2-2-1 (07886)		EA	REF	*	*	*	*		
A-0-R		TUNER, TRANSMISSION LINE 544-7230-000 (13499)		EA	1						1A2A2
X2-0		TRANSMISSION 544-7219-005 (13499)		EA	1						
X2-0		BOX WELDED 544-7218-005 (13499)		EA	1						
P-0		NUT, CAPTIVE NCM6-2-2-1 (07886)		EA	REF	*	*	*	*		
P-0		WASHER, LOCK 1722-01CADPL (78189)		EA	REF	*	*	*	*		
P-0	5310-269-6291	NUT, PLAIN, HEXAGON 8947-151 (04009)		EA	REF	*	*	*	*		
P-0	5355-814-8340	KNOB 542-7447-003 (13499)		EA	1	*	*	*	*	3-57	1A2A201



SECTION II REPAIR PARTS FOR ORGANIZATIONAL MAINTENANCE (CONTINUED)

(1) SIR CODE	(2) FEDERAL STOCK NUMBER	(3) DESCRIPTION	USABLE OR CODE	(4) UNIT OF MEAS	(5) QTY INC IN UNIT	(6) 15-DAY ORGANIZATIONAL MAINTENANCE ALW				(7) ILLUSTRATIONS	
						(a) 1-5	(b) 6-20	(c) 21-50	(d) 51-100	(a) FIG NO.	(b) ITEM NO. OR REFERENCE DESIGNATION
P-0	5305-054-5648	SCREW, MACHINE MS51937-14 (96906)		EA	REF	*	*	*	*		
P-0		PIN, SHOULDER, HEADED 542-7413-002 (13499)		EA	REF	*	*	*	*		
P-0	5355-774-5221	KNOB, DIAL-COUNTER 542-7411-002 (13499)		EA	REF	*	*	*	*		
P-0	5305-818-9349	SETScrew 328-0022-000 (08664)		EA	REF	*	*	*	*		
P-0		SCREW, MACHINE F321-0292-000 (77250)		EA	2	*	*	*	*		
P-0	5355-814-8192	KNOB-MODIFIED 544-7206-002 (13499)		EA	1	*	*	*	*		
XI-0		KNOB 064969-1G (82090)		EA	2					3-57	1A2A204
XI-0		SETScrew 335-0041-000 (08664)		EA	REF						
XI-0		KNOB 540-6241-002 (13499)		EA	1					3-57	1A201
P-0		SETScrew 328-0012-000 (08664)		EA	4	*	*	*	*		
P-0	5310-934-9748	NUT, PLAIN, HEXAGON MS37649-44 (96906)		EA	REF	*	*	*	*		
P-0	5305-054-5648	SCREW, MACHINE MS51937-14 (96906)		EA	REF	*	*	*	*		

SECTION III REPAIR PARTS FOR DIRECT SUPPORT, GENERAL SUPPORT, AND DEPOT MAINTENANCE

(1) SR CODE	(2) FEDERAL STOCK NUMBER	(3) DESCRIPTION  USABLE ON CODE	(4) UNIT OF MEAS	(5) QTY REQ IN UNIT	(6) 30-DAY DS MAINT ALLOWANCE			(7) 30-DAY GS MAINT ALLOWANCE			(8) 1 YR ALW PER EQUIP CATEG	(9) DEPOT MAINT ALW PER 100 EQUIP	(10) ILLUSTRATIONS	
					(a)	(b)	(c)	(a)	(b)	(c)			(a)	(b)
					1-20	21-50	51-100	1-20	21-50	51-100			FIG NO.	ITEM NO. OR REFERENCE DESIGNATION
		TRANSCEIVER KDF6-B (THIS ITEM IS NONDEPENDABLE)												
A-O-R		TRANSCEIVER 522-2052-011 (13499)	EA	1										1
		GROUP 01-FREQUENCY GENERATOR 786-1												
A-O-R		FREQUENCY GENERATOR 522-0860-013 (13499)	EA	1								3-1	1A4	
M-D		PLATE, IDENTIFICATION 280-1254-000 (12998)	EA	13										
M-D		PLATE, IDENTIFICATION 546-7989-002 (13499)	EA	1										
P-F		SCREW, TAPPING, THREAD 2XL-8PANEDTYPBCADPL (45722)	EA	30	*	*	*	*	*	*	*			
P-F	5305-054-5635	SCREW, MACHINE MS1957-1 (96906)	EA	20	*	*	*	*	*	*	*			
A-O-R		GENERATOR, FREQUENCY 542-7787-000 (13499)	EA	1										
P-C	6240-155-7836	LAMP, INCANDESCENT MS25237-327 (96906)	EA	4	*	*	*	*	*	*	*	3-3	1A4DS1	
P-O	6240-155-7836	LAMP, INCANDESCENT MS25237-327 (96906)	EA	REF	*	*	*	*	*	*	*	3-3	1A4DS2	
P-O	6240-155-7836	LAMP, INCANDESCENT MS25237-327 (96906)	EA	REF	*	*	*	*	*	*	*		1A4DS3	
P-O	6240-155-7836	LAMP, INCANDESCENT MS25237-327 (96906)	EA	REF	*	*	*	*	*	*	*		1A4DS4	
P-O	6210-813-2725	LIGHT, INDICATOR A9849-1 (72914)	EA	4	*	*	*	*	*	*	*	3-3	1A4XDS1	
P-O	6210-813-2725	LIGHT, INDICATOR A9849-1 (72914)	EA	REF	*	*	*	*	*	*	*	3-3	1A4XDS2	
P-O	6210-813-2725	LIGHT, INDICATOR A9849-1 (72914)	EA	REF	*	*	*	*	*	*	*		1A4XDS3	
P-O	6210-813-2725	LIGHT, INDICATOR A9849-1 (72914)	EA	REF	*	*	*	*	*	*	*		1A4XDS4	
P-F	6210-814-3204	LIGHT, INDICATOR A9848-1 (72914)	EA	4	*	*	*	*	*	*	*	3-3	1A4E1	
P-F	6210-814-3204	LIGHT, INDICATOR A9848-1 (72914)	EA	REF	*	*	*	*	*	*	*	3-3	1A4E2	
P-F	6210-814-3204	LIGHT, INDICATOR A9848-1 (72914)	EA	REF	*	*	*	*	*	*	*		1A4E3	
P-F	6210-814-3204	LIGHT, INDICATOR A9848-1 (72914)	EA	REF	*	*	*	*	*	*	*		1A4E4	
P-F	5935-577-8713	CONNECTOR, RECEPTACLE, ELECTRICAL 143-010-01 (02660)	EA	4	*	*	*	*	*	*	*	3-2	1A4J3	
P-F	5935-577-8713	CONNECTOR, RECEPTACLE, ELECTRICAL 143-010-01 (02660)	EA	REF	*	*	*	*	*	*	*	3-2	1A4J5	
P-F	5935-577-8713	CONNECTOR, RECEPTACLE, ELECTRICAL 143-010-01 (02660)	EA	REF	*	*	*	*	*	*	*	3-2	1A4J6	
P-F	5325-263-6632	GROMMET, RUBBER MS37489-6 (96906)	EA	2	*	*	*	*	*	*	*			
P-F		NUT, FLAT, HEXAGON P334-0254-000 (77250)	EA	31	*	*	*	*	*	*	*			
P-F		TERMINAL, LUG 4007-6SHOTTIBRED (77147)	EA	4	*	*	*	*	*	*	*			

SECTION III REPAIR PARTS FOR DIRECT SUPPORT, GENERAL SUPPORT, AND DEPOT MAINTENANCE (CONTINUED)

(1) SR CODE	(2) FEDERAL STOCK NUMBER	(3) DESCRIPTION  REFERENCE NUMBER & MFR. CODE	(4) UNIT OF MEAS	(5) QTY INC IN UNIT	(6) 30-DAY DS MAINT ALLOWANCE			(7) 30-DAY GS MAINT ALLOWANCE			(8) 1 YR ALW PER EQUIP CNTCTY	(9) DEPOT MAINT ALW PER 100 EQUIP	(10) ILLUSTRATIONS		
					USABLE ON CODE	(a) 1-20	(b) 21-50	(c) 51-100	(a) 1-20	(b) 21-50			(c) 51-100	(a) FIG NO.	(b) ITEM NO. OR REFERENCE DESIGNATION
P-F		TERMINAL, LUG 2104-06-02-2520N (78189)	EA	24	*	*	*	*	*	*	*				
P-F	5930-577-0135	SWITCH, TOGGLE 86709EM (04009)	EA	1	*	*	*	*	*	*	*	3-3	1A452		
P-O	5355-817-5564	KNOB 116-217 (74970)	EA	1	*	*	*	*	*	*	*	3-3	1A401		
P-O	5355-821-5824	KNOB 116-260 (74970)	EA	1	*	*	*	*	*	*	*	3-3	1A402		
P-O	5310-054-1830	WASHER, LOCK MS35338-80 (96906)	EA	50	*	*	*	*	*	*	*				
P-F	5310-275-1347	WASHER, FLAT 310-0046-000 (79807)	EA	42	*	*	*	*	*	*	*				
P-F		SCREW, MACHINE P342-0154-000 (77250)	EA	9	*	*	*	*	*	*	*				
P-F	5305-054-5649	SCREW, MACHINE MS51957-15 (96906)	EA	21	*	*	*	*	*	*	*				
P-F	5310-595-5421	WASHER, FLAT 310-6320-000 (79807)	EA	26	*	*	*	*	*	*	*				
P-F	5310-011-1041	WASHER, LOCK MS35338-79 (96906)	EA	313	*	*	*	*	*	*	*				
P-F		NUT, FLAIN, HEXAGON P313-0051-000 (77250)	EA	65	*	*	*	*	*	*	*				
P-F	5310-042-9609	WASHER, LOCK MS35338-78 (96906)	EA	217	*	*	*	*	*	*	*				
P-F		WASHER, FLAT 310-0044-000 (79807)	EA	8	*	*	*	*	*	*	*				
P-F	5310-058-2950	WASHER, LOCK MS35337-77 (96906)	EA	12	*	*	*	*	*	*	*				
P-F		NUT, FLAIN, HEXAGON P313-0053-000 (77250)	EA	26	*	*	*	*	*	*	*				
X2-F		HOLDER, WRENCH 505-0834-003 (13499)	EA	1	*	*	*	*	*	*	*				
P-F		NUT, FLAIN, HEXAGON P313-0149-000 (77250)	EA	69	*	*	*	*	*	*	*				
P-F	5310-271-4640	NUT, FLAIN, HEXAGON MS35649-24 (96906)	EA	69	*	*	*	*	*	*	*				
P-F	5340-634-7444	RING, RETAINING MS16632-1018 (96906)	EA	22	*	*	*	*	*	*	*				
P-F		SETScrew 10-32X5-56SPLINE416SST (08664)	EA	14	*	*	*	*	*	*	*				
P-F	5305-765-4257	SCREW, MACHINE MS51959-43 (96906)	EA	28	*	*	*	*	*	*	*				
P-F	5305-071-1322	SCREW, MACHINE MS35201-55 (96906)	EA	2	*	*	*	*	*	*	*				
P-F	5305-764-0064	SCREW, MACHINE MS51959-32 (96906)	EA	4	*	*	*	*	*	*	*				
P-F	5635-763-6963	SCREW, MACHINE MS51959-28 (96906)	EA	71	*	*	*	*	*	*	*				
P-F	5305-719-5064	SCREW, MACHINE MS51959-30 (96906)	EA	8	*	*	*	*	*	*	*				
P-F		SCREW, MACHINE P342-0168-000 (77250)	EA	12	*	*	*	*	*	*	*				
P-F		SCREW, MACHINE P343-0330-000 (77250)	EA	9	*	*	*	*	*	*	*				

SECTION III REPAIR PARTS FOR DIRECT SUPPORT, GENERAL SUPPORT, AND DEPOT MAINTENANCE (CONTINUED)

(1) SFR CODE	(2) FEDERAL STOCK NUMBER	(3) DESCRIPTION  REFERENCE NUMBER & MFR. CODE	(4) UNIT OF MEAS	(5) QTY INC IN UNIT	(6) 30-DAY DS MAINT ALLOWANCE			(7) 30-DAY GS MAINT ALLOWANCE			(8) 1 YR ALW PER EQUIP CONTACT	(9) DEPOT MAINT ALW PER 100 EQUIP	(10) ILLUSTRATIONS	
					(a) 1-20	(b) 21-50	(c) 51-100	(a) 1-20	(b) 21-50	(c) 51-100			(a) FIG NO.	(b) ITEM NO. OR REFERENCE DESIGNATION
P-F	5305-054-6654	SCREW, MACHINE MS51957-30 (96906)	EA	25	*	*	*	*	*	*	*			
P-F	5305-054-5647	SCREW, MACHINE MS51957-13 (96906)	EA	160	*	*	*	*	*	*	*			
P-O	5120-813-0232	WRENCH 544-6032-002 (13499)	EA	1	*	*	*	*	*	*	*			
XI-O		KEY, SOCKET HEAD SCREW 8096 (08664)	EA	1										
XI-O		SHAFT, WRENCH 505-0800-002 (13499)	EA	1										
XI-O		HANDLE, WRENCH 544-6033-002 (13499)	EA	1										
P-F	5305-054-5650	SCREW, MACHINE MS51957-16 (96906)	EA	9	*	*	*	*	*	*	*			
P-F	5305-054-6651	SCREW, MACHINE MS51957-27 (96906)	EA	113	*	*	*	*	*	*	*			
P-F	5305-763-3357	SCREW, MACHINE MS51959-6 (96906)	EA	12	*	*	*	*	*	*	*			
P-F	5305-054-6653	SCREW, MACHINE MS51957-29 (96906)	EA	89	*	*	*	*	*	*	*			
P-F		WASHER, LOCK 1718-02 (A)PL (78189)	EA	20	*	*	*	*	*	*	*			
P-F		SCREW, MACHINE MS35200-3 (96906)	EA	2	*	*	*	*	*	*	*			
P-F	5305-579-3508	SCREW, MACHINE MS35216-43 (96906)	EA	4	*	*	*	*	*	*	*			
P-F		CONNECTOR, RECEPTACLE, ELECTRICAL UG1094U (80058)	EA	6	*	*	*	*	*	*	*	3-2	1A4J10	
P-F		CONNECTOR, RECEPTACLE, ELECTRICAL UG1094U (80058)	EA	REF	*	*	*	*	*	*	*	3-2	1A4J11	
P-F		CONNECTOR, RECEPTACLE, ELECTRICAL UG1094U (80058)	EA	REF	*	*	*	*	*	*	*	3-2	1A4J12	
P-F		CONNECTOR, RECEPTACLE, ELECTRICAL UG1094U (80058)	EA	REF	*	*	*	*	*	*	*	3-2	1A4J13	
P-F		CONNECTOR, RECEPTACLE, ELECTRICAL UG1094U (80058)	EA	REF	*	*	*	*	*	*	*	3-2	1A4J14	
P-F	5935-853-7596	CONNECTOR, RECEPTACLE, ELECTRICAL UG1094U (80058)	EA	REF	*	*	*	*	*	*	*	3-2	1A4J15	
P-F		CONNECTOR, RECEPTACLE, ELECTRICAL MS35179-1094A (96906)	EA	6	*	*	*	*	*	*	*	3-2	1A4J10	
P-F		CONNECTOR, RECEPTACLE, ELECTRICAL MS35179-1094A (96906)	EA	REF	*	*	*	*	*	*	*	3-2	1A4J11	
P-F		CONNECTOR, RECEPTACLE, ELECTRICAL MS35179-1094A (96906)	EA	REF	*	*	*	*	*	*	*	3-2	1A4J12	
P-F		CONNECTOR, RECEPTACLE, ELECTRICAL MS35179-1094A (96906)	EA	REF	*	*	*	*	*	*	*	3-2	1A4J13	
P-F		CONNECTOR, RECEPTACLE, ELECTRICAL MS35179-1094A (96906)	EA	REF	*	*	*	*	*	*	*	3-2	1A4J14	
P-F		CONNECTOR, RECEPTACLE, ELECTRICAL MS35179-1094A (96906)	EA	REF	*	*	*	*	*	*	*	3-2	1A4J15	
P-F	5310-058-3599	WASHER, LOCK MS35335-57 (96906)	EA	94	*	*	*	*	*	*	*			
P-F	5310-209-1366	WASHER, LOCK MS35335-58 (96906)	EA	166	*	*	*	*	*	*	*			

SECTION III REPAIR PARTS FOR DIRECT SUPPORT, GENERAL SUPPORT, AND DEPOT MAINTENANCE (CONTINUED)

(1) SIC CODE	(2) FEDERAL STOCK NUMBER	(3) DESCRIPTION  USABLE ON CODE	(4) UNIT OF MEAS	(5) QTY REQ IN UNIT	(6) 30-DAY DS MAINT ALLOWANCE			(7) 30-DAY GS MAINT ALLOWANCE			(8) 1 YR ALY PER EQUIP CWTQY	(9) DEPOT MAINT ALY PER 100 EQUIP	(10) ILLUSTRATIONS	
					(a)	(b)	(c)	(a)	(b)	(c)			(a) FIG NO.	(b) ITEM NO. OR REFERENCE DESIGNATION
					1-20	21-60	61-100	1-20	21-60	61-100				
P-F		WASHER, LOCK 1714-03CADPL (78189)	EA	77	*	*	*	*	*	*	*	*		
P-F	6625-679-9555	ARMSTER 1008200K1CS (81030)	EA	1	*	*	*	*	*	*	*	*	3-3	1A4M1
XZ-F		PLATE, PIVOT 540-7369-002 (13499)	EA	2										
P-F	5315-791-7836	SCREW, EXTERNALLY THREADED 540-6241-002 (13499)	EA	16	*	*	*	*	*	*	*	*		
XZ-F		PLATE, HINGE 540-6240-002 (13499)	EA	16										
XI-F		BLOCK, SPACER 540-6433-002 (13499)	EA	1										
XI-F		BLOCK, SPACER 540-6434-002 (13499)	EA	1										
P-F		POST, FRONT 540-6435-002 (13499)	EA	2	*	*	*	*	*	*	*	*		
P-F		POST, SPACING 540-9221-003 (13499)	EA	4	*	*	*	*	*	*	*	*		
P-F		POST, SPACING 542-7523-002 (13499)	EA	6	*	*	*	*	*	*	*	*		
P-F		POST, SPACING 542-7524-002 (13499)	EA	15	*	*	*	*	*	*	*	*		
P-F		POST, STAND OFF 561-2169-002 (13499)	EA	26	*	*	*	*	*	*	*	*		
P-F		POST, MOUNTING 543-3079-002 (13499)	EA	1	*	*	*	*	*	*	*	*		
P-F		POST, SUPPORT 543-3142-002 (13499)	EA	2	*	*	*	*	*	*	*	*		
XZ-F		BRACKET, CONNECTOR 543-3188-002 (13499)	EA	1										
XZ-F		BRACKET, CONNECTOR 543-3187-002 (13499)	EA	1										
P-F		BUT, CAPTIVE HENS-2-2-1 (07886)	EA	43	*	*	*	*	*	*	*	*		
P-F		WASHER, LOCK 1722-01CADPL (78189)	EA	8	*	*	*	*	*	*	*	*		
P-F		TERMINAL, LUG 409080TT188D (77147)	EA	6	*	*	*	*	*	*	*	*		
XZ-F		COVER, ELECTRICAL CONNECTOR 543-3185-002 (13499)	EA	1										
XZ-F		PLATE, SIDING 543-3186-002 (13499)	EA	1										
M-H		BUMPER, CHASSIS 543-3184-002 (13499)	EA	2										
XZ-F		PLATE, HINGE 543-3183-002 (13499)	EA	1										
XI-F		FIN, GROOVED 541-3627-002 (13499)	EA	32										
XI-F		PLATE, HINGE 543-3182-002 (13499)	EA	1										
M-H		WIRING HARNESS 543-3060-000 (13499)	EA	1										
M-H		WIRE, ELECTRICAL MILW168781YF822-9 (81349)	FT	95										

SECTION III REPAIR PARTS FOR DIRECT SUPPORT, GENERAL SUPPORT, AND DEPOT MAINTENANCE (CONTINUED)

(1) SR CODE	(2) FEDERAL STOCK NUMBER	(3) DESCRIPTION  REFERENCE NUMBER & MFR. CODE	(4) UNIT OF MEAS	(5) QTY REQ. IN UNIT	(6) 30-DAY DS MAINT ALLOWANCE			(7) 30-DAY GS MAINT ALLOWANCE			(8) 1 YR ALY PER EQUIP CMTY	(9) DEPOT MAINT ALY PER 100 EQUIP	(10) ILLUSTRATIONS	
					(a)	(b)	(c)	(a)	(b)	(c)			(a)	(b)
					1-20	21-50	51-100	1-20	21-50	51-100			FIG NO.	ITEM NO. OR REFERENCE DESIGNATION
M-H		WIRE, ELECTRICAL MILW16878TTPER22-90 (81349)	FT	36										
M-H		WIRE, ELECTRICAL MILW16878TTPER22-91 (81349)	FT	46										
M-H		WIRE, ELECTRICAL MILW16878TTPER22-92 (81349)	FT	36										
M-H		WIRE, ELECTRICAL MILW16878TTPER22-93 (81349)	FT	35										
M-H		WIRE, ELECTRICAL MILW16878TTPER22-95 (81349)	FT	49										
M-H		WIRE, ELECTRICAL MILW16878TTPER22-96 (81349)	FT	23										
M-H		WIRE, ELECTRICAL MILW16878TTPER22-902 (81349)	FT	31										
M-H		WIRE, ELECTRICAL MILW16878TTPER22-903 (81349)	FT	24										
M-H		WIRE, ELECTRICAL MILW16878TTPER22-905 (81349)	FT	27										
M-H		WIRE, ELECTRICAL MILW16878TTPER22-906 (81349)	FT	21										
M-H		WIRE, ELECTRICAL MILW16878TTPER22-912 (81349)	FT	24										
M-H		WIRE, ELECTRICAL MILW16878TTPER22-913 (81349)	FT	30										
M-H		WIRE, ELECTRICAL MILW16878TTPER22-915 (81349)	FT	26										
M-H		WIRE, ELECTRICAL MILW16878TTPER22-916 (81349)	FT	16										
M-H		WIRE, ELECTRICAL MILW16878TTPER22-926 (81349)	FT	36										
M-H		WIRE, ELECTRICAL MILW16878TTPER22-912-3 (81349)	FT	15										
M-H		WIRE, ELECTRICAL MILW16878TTPER22-935 (81349)	FT	24										
M-H		WIRE, ELECTRICAL MILW16878TTPER22-936 (81349)	FT	25										
M-H		WIRE, ELECTRICAL MILW16878TTPER22-902-3 (81349)	FT	13										
M-H		WIRE, ELECTRICAL MILW16878TTPER22-902-5 (81349)	FT	15										
M-H		WIRE, ELECTRICAL MILW16878TTPER22-902-6 (81349)	FT	19										
M-H		CABLE, SPECIAL PURPOSE, ELECTRICAL 1S8U8730890 (90484)	FT	13										
M-H		CABLE, SPECIAL PURPOSE, ELECTRICAL 1S8U8730891 (90484)	FT	13										
M-H		CABLE, SPECIAL PURPOSE, ELECTRICAL 1S8U8730892 (90484)	FT	16										
M-H		CABLE, SPECIAL PURPOSE, ELECTRICAL 1S8U8730893 (90484)	FT	15										
M-H		CABLE, SPECIAL PURPOSE, ELECTRICAL 1S8U8730895 (90484)	FT	7										
M-H		CABLE, RADIO FREQUENCY RCL96AN (80058)	FT	22										

SECTION III REPAIR PARTS FOR DIRECT SUPPORT, GENERAL SUPPORT, AND DEPOT MAINTENANCE (CONTINUED)

(1) SIR CODE	(2) FEDERAL STOCK NUMBER	(3) DESCRIPTION  REFERENCE NUMBER & MFR. CODE	(4) UNIT OF MEAS	(5) QTY REQ PER UNIT	(6) 30-DAY DS MAINT ALLOWANCE			(7) 30-DAY GS MAINT ALLOWANCE			(8) 1 YR ALW PER EQUIP CENTRY	(9) DEPOT MAINT ALW PER 100 EQUIP	(10) ILLUSTRATIONS	
					(a) 1-20	(b) 21-50	(c) 51-100	(a) 1-20	(b) 21-50	(c) 51-100			(a) FIG NO.	(b) ITEM NO. OR REFERENCE DESIGNATION
M-H		WIRE, ELECTRICAL 00702-1322 (70567)	FT	51										
M-H		WIRE, ELECTRICAL MILW168787TTPRC20-90 (81349)	FT	1										
M-H		WIRE, ELECTRICAL MILW168787TTPRC20-91 (81349)	FT	4										
P-F	5935-989-4399	CONNECTOR, RECEPTACLE, ELECTRICAL DCF37S (71468)	EA	2	*	*	*	*	*	*	*	*	3-2	1A4J1
P-F	5935-989-4399	CONNECTOR, RECEPTACLE, ELECTRICAL DCF37S (71468)	EA	REF	*	*	*	*	*	*	*	*	3-2	1A4J7
P-F	5935-993-2181	CONNECTOR, RECEPTACLE, ELECTRICAL DAF15S (71468)	EA	1	*	*	*	*	*	*	*	*	3-2	1A4J2
P-F	5935-577-8713	CONNECTOR, RECEPTACLE, ELECTRICAL 143-010-01 (96906)	EA	REF	*	*	*	*	*	*	*	*	3-2	1A4J4
M-H		INSULATION SLEEVING, ELECTRICAL TPTVLAB (81851)	FT	2										
M-H		INSULATION SLEEVING, ELECTRICAL TPTVLIB (81851)	FT	6										
M-H		INSULATION SLEEVING, ELECTRICAL TPTVLOB (81851)	FT	7										
P-F	5325-249-6341	GRANITE, RUBBER MS35489-67 (96906)	EA	1	*	*	*	*	*	*	*	*		
P-H		CORD, NYLON 435-1014-000 (13499)	FT	504				*	*	*	*	*		
P-F	5935-965-5571	ADAPTER, CABLE YK1620F32 (09922)	EA	9	*	*	*	*	*	*	*	*		
X2-F		BLOCK, CENTER 543-3201-003 (13499)	EA	1										
X2-F		PLATE, SPACER 543-3202-003 (13499)	EA	1										
X2-F		PANEL, COUNTER 544-9803-003 (13499)	EA	1										
X2-F		BRACKET, SUPPORT 544-4808-004 (13499)	EA	1										
A-F		GEAR TRAIN STABILIZED MO TUNER 543-3196-003 (13499)	EA	1										
P-F		SCREW, CAPTIVE, SOCKET HEAD 4-40X1-26SPLDRCAEFL (08664)	EA	6	*	*	*	*	*	*	*	*		
P-F		SCREW, CAPTIVE 324-1682-100 (13499)	EA	12	*	*	*	*	*	*	*	*		
P-F		NUT, PLAIN SQUARE P334-0486-080 (77250)	EA	13	*	*	*	*	*	*	*	*		
P-F	5305-763-6963	SCREW, MACHINE MS51959-30 (96906)	EA	REF	*	*	*	*	*	*	*	*		
P-F	5305-054-6653	SCREW, MACHINE MS51957-29 (96906)	EA	REF	*	*	*	*	*	*	*	*		
P-F	3030-814-9043	BEELT, POSITIVE DRIVE 9471X1-8 (61463)	EA	1	*	*	*	*	*	*	*	*		
X2-F		PLATE, GEAR 543-3194-003 (13499)	EA	1										
X1-F		BEARING, SLEEVE F219M116085A (70417)	EA	2										1A4MP42
X1-F		BEARING, SLEEVE F219M116085A (70417)	EA	REF										1A4MP45

SECTION III REPAIR PARTS FOR DIRECT SUPPORT, GENERAL SUPPORT, AND DEPOT MAINTENANCE (CONTINUED)

(1) S&R CODE	(2) FEDERAL STOCK NUMBER	(3) DESCRIPTION  REFERENCE NUMBER & MFR. CODE	(4) UNIT OF MEAS	(5) QTY INC IN UNIT	(6) 30-DAY DS MAINT ALLOWANCE			(7) 30-DAY GS MAINT ALLOWANCE			(8) 1 YR ALN PER EQUIP CWBCT	(9) DEPOT MAINT ALN PER 100 EQUIP	(10) ILLUSTRATIONS		
					USABLE ON CODE	(a) 1-20	(b) 21-50	(c) 51-100	(a) 1-20	(b) 21-50			(c) 51-100	(a) FIG NO.	(b) ITEM NO. OR REFERENCE DESIGNATION
X2-F		PLATE, GEAR 543-3198-003 (13499)	EA	1											
P-F	5310-550-0989	SELF-LOCKING, CLINCH 68NC4-62 (72962)	EA	4	*	*	*	*	*	*	*				
X2-F		PLATE, GEAR 543-3199-003 (13499)	EA	1											
X1-F		BEARING, SLEEVE F219M116085A (70417)	EA	REF											
X2-F		PLATE, GEAR 543-3197-003 (13499)	EA	1											
P-F	5310-297-9071	NUT, SELF-LOCKING, CLINCH 68NC2-62 (72962)	EA	17	*	*	*	*	*	*	*				
P-F	5820-787-6030	GEAR SUBASSEMBLY 543-3088-002 (13499)	EA	1	*	*	*	*	*	*	*				
X1-F		PIN, SPRING MS16562-190 (96906)	EA	2											
P-F	5340-634-7444	RING, RETAINING MS16632-1018 (96906)	EA	REF	*	*	*	*	*	*	*				
X1-F		PULLEY, STAKED 543-3079-002 (13499)	EA	2								3-3	1AAMP39		
X1-F		PULLEY, STAKED 543-3079-002 (13499)	EA	REF								3-3	1AAMP46		
P-F		WASHER, PULLEY 542-7483-003 (13499)	EA	3	*	*	*	*	*	*	*				
X1-F		PULLEY, BELT 543-3137-002 (13499)	EA	1											
X2-F		CLAMP, SHAFT 543-3078-002 (13499)	EA	4								3-3	1AAMP47		
X2-F		CLAMP, SHAFT 543-3078-002 (13499)	EA	REF								3-3	1AAMP71		
X2-F		CLAMP, SHAFT 543-3078-002 (13499)	EA	REF								3-3	1AAMP72		
X2-F		CLAMP, SHAFT 543-3078-002 (13499)	EA	REF								3-3	1AAMP77		
P-F	5820-794-2034	GEAR, SPUR 543-3124-002 (13499)	EA	1	*	*	*	*	*	*	*	3-3	1AAMP48		
X1-F		SHAFT, STRAIGHT 543-3124-002 (13499)	EA	1								3-3	1AAMP49		
P-F		WASHER, PULLEY 542-7483-003 (13499)	EA	REF	*	*	*	*	*	*	*				
P-F		NUT, FLAIN, SQUARE P334-0485-000 (77250)	EA	3	*	*	*	*	*	*	*				
P-F		NUT, FLAIN SQUARE P334-0486-000 (77250)	EA	REF	*	*	*	*	*	*	*				
P-F		SCREW, CAPTIVE, SOCKETHEAD 4-40X1-26SPLINEGADFL (08664)	EA	REF	*	*	*	*	*	*	*				
P-F		SCREW, CAPTIVE 324-1682-100 (13499)	EA	REF	*	*	*	*	*	*	*				
P-F	5820-787-6032	GEAR, SUBASSEMBLY 543-3089-002 (13499)	EA	1	*	*	*	*	*	*	*				
P-H	5820-936-8375	HUB ASSEMBLY-GEAR 756-4309-002 (13499)	EA	1				*	*	*	*				
X1-H		HUB-GEAR 543-3122-002 (13499)	EA	1											



SECTION III REPAIR PARTS FOR DIRECT SUPPORT, GENERAL SUPPORT, AND DEPOT MAINTENANCE (CONTINUED)

(1) SIR CODE	(2) FEDERAL STOCK NUMBER	(3) DESCRIPTION  REFERENCE NUMBER & MFR. CODE	(4) USABLE OR CODE	(5) UNIT OF MEAS  QTY INC IN UNIT	(6) 30-DAY DS MAINT ALLOWANCE			(7) 30-DAY GS MAINT ALLOWANCE			(8) 1 YR ALW PER EQUIP CATGRY	(9) DEPOT MAINT ALW PER 100 EQUIP	(10) ILLUSTRATIONS	
					(a) 1-20	(b) 21-50	(c) 51-100	(a) 1-20	(b) 21-50	(c) 51-100			(a) FIG NO.	(b) ITEM NO. OR REFERENCE DESIGNATION
XI-H		SHAFT 543-3125-002 (13499)		EA	1									
P-H	5820-795-9328	GEAR-FLOATING 543-3076-002 (13499)		EA	1			*	*	*	*	*		
P-H	5820-794-2040	GEAR-FIXED 543-3131-002 (13499)		EA	1			*	*	*	*	*		
P-F	5340-634-7444	RING, RETAINING MS16632-1018 (96906)		EA	REF	*	*	*	*	*	*	*		
P-H	5820-537-4835	SPRING, HELICAL 506-2068-002 (13499)		EA	10			*	*	*	*	*	3-3	1AAMP15
P-H	5820-537-4835	SPRING, HELICAL 506-2068-002 (13499)		EA	REF			*	*	*	*	*	3-3	1AAMP16
P-H	5820-537-4835	SPRING, HELICAL 506-2068-002 (13499)		EA	REF			*	*	*	*	*	3-3	1AAMP50
P-H	5820-537-4835	SPRING, HELICAL 506-2068-002 (13499)		EA	REF			*	*	*	*	*	3-3	1AAMP51
P-H	5820-537-4835	SPRING, HELICAL 506-2068-002 (13499)		EA	REF			*	*	*	*	*	3-3	1AAMP56
P-H	5820-537-4835	SPRING, HELICAL 506-2068-002 (13499)		EA	REF			*	*	*	*	*	3-3	1AAMP57
P-H	5820-537-4835	SPRING, HELICAL 506-2068-002 (13499)		EA	REF			*	*	*	*	*	3-3	1AAMP58
P-H	5820-537-4835	SPRING, HELICAL 506-2068-002 (13499)		EA	REF			*	*	*	*	*	3-3	1AAMP59
P-H	5820-537-4835	SPRING, HELICAL 506-2068-002 (13499)		EA	REF			*	*	*	*	*	3-3	1AAMP80
P-H	5820-537-4835	SPRING, HELICAL 506-2068-002 (13499)		EA	REF			*	*	*	*	*	3-3	1AAMP81
P-F	5820-788-5143	GEAR SUBASSEMBLY 543-3090-002 (13499)		EA	1	*	*	*	*	*	*	*		
P-F		SETScrew 4-48X1-86SPLINROVPT18-8 SST (08664)		EA	6	*	*	*	*	*	*	*		
P-F	5340-200-2637	RING, RETAINING MS16624-12 (96906)		EA	6	*	*	*	*	*	*	*		
P-H	5820-537-4835	SPRING, HELICAL 506-2068-002 (13499)		EA	REF			*	*	*	*	*		
P-H	5820-794-2050	GEAR, SPUR-FLOATING 543-3077-002 (13499)		EA	2			*	*	*	*	*	3-3	1AAMP61
P-H	5820-794-2050	GEAR, SPUR-FLOATING 543-3077-002 (13499)		EA	REF			*	*	*	*	*	3-3	1AAMP62
P-H	5820-794-2035	GEAR, SPUR-DRIVE 543-3123-002 (13499)		EA	2			*	*	*	*	*	3-3	1AAMP63
P-H	5820-794-2035	GEAR, SPUR-DRIVE 543-3123-002 (13499)		EA	REF			*	*	*	*	*	3-3	1AAMP64
P-H	5820-794-2036	GEAR, SPUR-FIXED 543-3130-002 (13499)		EA	1			*	*	*	*	*	3-3	1AAMP66
XI-H		SHAFT, STRAIGHT-GEAR 543-3127-002 (13499)		EA	1								3-3	1AAMP67
P-F	5820-788-5144	GEAR SUBASSEMBLY 543-3091-002 (13499)		EA	1	*	*	*	*	*	*	*		
P-F		SETScrew 4-48X1-86SPLINROVPT18-8SST (08664)		EA	REF	*	*	*	*	*	*	*		
P-F	5340-200-2637	RING, RETAINING MS16624-12 (96906)		EA	REF	*	*	*	*	*	*	*		

SECTION III REPAIR PARTS FOR DIRECT SUPPORT, GENERAL SUPPORT, AND DEPOT MAINTENANCE (CONTINUED)

(1) SR CODE	(2) FEDERAL STOCK NUMBER	(3) DESCRIPTION  REFERENCE NUMBER & MFR. CODE	(4) USABLE ON CODE	(5) UNIT OF MEAS  QTY INC 1# UNIT	(6) 30-DAY DS MAINT ALLOWANCE			(7) 30-DAY GS MAINT ALLOWANCE			(8) 1 YR ALM PER EQUIP CTRYCY	(9) DEPOT MAINT ALW PER 100 EQUIP	(10) ILLUSTRATIONS	
					(a) 1-20	(b) 21-50	(c) 51-100	(a) 1-20	(b) 21-50	(c) 51-100			(a) FIG NO.	(b) ITEM NO. OR REFERENCE DESIGNATION
					P-H	5820-537-4835	SPRING, HELICAL 506-2068-002 (13499)		EA	REF				
P-H	3020-794-2033	GEAR, SPUR-FIXED 543-3121-002 (13499)		EA	1				*	*	*		3-3	1AAMP60
P-H	5820-794-2050	GEAR, SPUR-FLOATING 543-3077-002 (13499)		EA	REF				*	*	*			
P-H	5820-794-2035	GEAR, SPUR-DRIVE 543-3123-002 (13499)		EA	REF				*	*	*			
XI-H		SHAFT, STRAIGHT-GEAR 543-3126-002 (13499)		EA	1								3-3	1AAMP65
X2-H		SUPPORT, GEAR 543-3092-002 (13499)		EA	1									
X2-H		SUPPORT, GEAR 543-3093-002 (13499)		EA	1									
P-H	5820-787-6029	IDLER, PRESSED 543-3087-002 (13499)		EA	1				*	*	*		3-3	1AAMP68
P-F	5340-903-7567	RING, RETAINING MS16624-18 (96906)		EA	7	*	*	*	*	*	*			
XI-H		SHAFT LOCK, ELECTRICAL 543-3062-002 (13499)		EA	1									
XI-H		SHAFT, STRAIGHT 543-3061-002 (13499)		EA	1									
X2-H		IDLER, RIVETED 543-3065-002 (13499)		EA	1									
P-H	5820-812-1968	COUPLING HALF 543-3099-002 (13499)		EA	3				*	*	*		3-3	1AAMP38
P-H	5820-812-1968	COUPLING HALF 543-3099-002 (13499)		EA	REF				*	*	*		3-3	1AAMP69
P-H	5820-812-1968	COUPLING HALF 543-3099-002 (13499)		EA	REF				*	*	*		3-3	1AAMP70
XI-H		COUPLING HALF 543-3193-003 (13499)		EA	3									
P-F	5315-852-5329	PIN, GROOVED HEAD GP7-093X375-50 (73957)		EA	3	*	*	*	*	*	*			
P-F		SPACER, DOWEL 543-3120-002 (13499)		EA	4	*	*	*	*	*	*			
X2-H		CLAMP, SHAFT 543-3078-002 (13499)		EA	REF									
P-H		BEARING BALL, ANNULAR S618FCRHP37102 (40920)		EA	2				*	*	*		3-3	1AAMP73
P-H		BEARING BALL, ANNULAR S618FCRHP37102 (40920)		EA	REF				*	*	*		3-3	1AAMP74
P-H		BEARING, BALL ANNULAR S6632FCRHP37102 (40920)		EA	10				*	*	*		3-3	1AAMP5
P-H		BEARING, BALL ANNULAR S6632FCRHP37102 (40920)		EA	REF				*	*	*		3-3	1AAMP6
P-H		BEARING, BALL ANNULAR S6632FCRHP37102 (40920)		EA	REF				*	*	*		3-3	1AAMP26
P-H		BEARING, BALL ANNULAR S6632FCRHP37102 (40920)		EA	REF				*	*	*		3-3	1AAMP40
P-H		BEARING, BALL ANNULAR S6632FCRHP37102 (40920)		EA	REF				*	*	*		3-3	1AAMP41
P-H		BEARING, BALL ANNULAR S6632FCRHP37102 (40920)		EA	REF				*	*	*		3-3	1AAMP43

SECTION III REPAIR PARTS FOR DIRECT SUPPORT, GENERAL SUPPORT, AND DEPOT MAINTENANCE (CONTINUED)

(1) SR CODE	(2) FEDERAL STOCK NUMBER	(3) DESCRIPTION  USABLE ON CODE	(4) UNIT OF MEAS	(5) QTY INC IN UNIT	(6) 30-DAY DS MAINT ALLOWANCE			(7) 30-DAY GS MAINT ALLOWANCE			(8) 1 YR ALN PER EQUIP CNTGTY	(9) DEPOT MAINT ALN PER 100 EQUIP	(10) ILLUSTRATIONS	
					(a)	(b)	(c)	(a)	(b)	(c)			(a) FIG NO.	(b) ITEM NO. REFERENCE DESIGNATION
					1-20	21-50	51-100	1-20	21-50	51-100				
P-H		BEARING, BALL ANNULAR S6632FCBHP37L02 (40920)	EA	REF				*	*	*	*	*	3-3	1AAMP75
P-H		BEARING, BALL ANNULAR S6632FCBHP37L02 (40920)	EA	REF				*	*	*	*	*	3-3	1AAMP76
P-H		BEARING, BALL ANNULAR S6632FCBHP37L02 (40920)	EA	REF				*	*	*	*	*	3-3	1AAMP82
P-F	5310-042-9606	WASHER, LOCK MS3538-78 (96906)	EA	REF	*	*	*	*	*	*	*	*		
P-F		WASHER 541-1234-003 (13499)	EA	3	*	*	*	*	*	*	*	*		
P-F		WASHER 543-5588-003 (13499)	EA	9	*	*	*	*	*	*	*	*		
X2-F		PLATE, MOUNTING 543-3210-004 (13499)	EA	1										
P-F		NUT, SELF-LOCKING CLINCH F22NC2434-2-82 (72962)	EA	34	*	*	*	*	*	*	*	*		
P-F		POST, MOUNTING CONNECTOR 543-1377-002 (13499)	EA	8	*	*	*	*	*	*	*	*		
X2-F		PLATE, MOUNTING, FREQUENCY 543-3215-005 (13499)	EA	1										
P-F		NUT, CAPTIVE NCR6-1-4 (07886)	EA	11	*	*	*	*	*	*	*	*		
X2-F		PANEL, POWER 543-3207-004 (13499)	EA	1										
A-F		PANEL, POWER 543-3211-005 (13499)	EA	1										
P-F	5930-679-9349	SWITCH SECTION, ROTARY 82661K (76854)	EA	1	*	*	*	*	*	*	*	*	3-3	1A651
P-F	5325-276-4221	GROMMET, RUBBER 911 (75543)	EA	4	*	*	*	*	*	*	*	*		
P-F		NUT, PLAIN, HEXAGON P313-0045-000 (77250)	EA	56	*	*	*	*	*	*	*	*		
P-F	5340-903-7567	RING, RETAINING MS16624-18 (96906)	EA	REF	*	*	*	*	*	*	*	*		
P-F	5340-282-0782	RING, RETAINING 5100-29C (79136)	EA	5	*	*	*	*	*	*	*	*		
P-F	5340-263-5877	RING, RETAINING MS16624-15 (96906)	EA	1	*	*	*	*	*	*	*	*		
F	5330-530-3549	WASHER, NON-METALLIC 8942 (76854)	EA	4	*	*	*	*	*	*	*	*		
P-F	5305-763-6961	SCREW, MACHINE MS51959-26 (96906)	EA	3	*	*	*	*	*	*	*	*		
P-F	5305-054-6652	SCREW, MACHINE MS51957-28 (96906)	EA	110	*	*	*	*	*	*	*	*		
P-F	5305-054-6650	SCREW, MACHINE MS51957-26 (96906)	EA	87	*	*	*	*	*	*	*	*		
P-F	5305-054-5647	SCREW, MACHINE MS51957-13 (96906)	EA	REF	*	*	*	*	*	*	*	*		
P-F	5305-7776039	SCREW, MACHINE MS51959-12 (96906)	EA	116	*	*	*	*	*	*	*	*		
P-F		SCREW, MACHINE P347-0008-000 (77250)	EA	2	*	*	*	*	*	*	*	*		
P-F	5305-054-6654	SCREW, MACHINE MS51957-30 (96906)	EA	REF	*	*	*	*	*	*	*	*		

SECTION III REPAIR PARTS FOR DIRECT SUPPORT, GENERAL SUPPORT, AND DEPOT MAINTENANCE (CONTINUED)

(1) SNR CODE	(2) FEDERAL STOCK NUMBER	(3) DESCRIPTION  REFERENCE NUMBER & MFR. CODE	USABLE OR CODE	(4) UNIT OF MEAS	(5) QTY INC 1st UNIT	(6) 30-DAY DS MAINT ALLOWANCE			(7) 30-DAY GS MAINT ALLOWANCE			(8) 1 YR ALW PER EQUIP CWTGCT	(9) DEPOT MAINT ALW PER 100 EQUIP	(10) ILLUSTRATIONS	
						(a) 1-20	(b) 21-50	(c) 51-100	(a) 1-20	(b) 21-50	(c) 51-100			(a) FIG NO.	(b) ITE: NO. OR REFERENCE DESIGNATION
						P-F	5310-907-0958	WASHER, FLAT 310-0045-000 (79807)		EA	15			*	*
P-F	5310-209-1366	WASHER, LOCK MS35335-58 (96906)		EA	REF	*	*	*	*	*	*	*	*		
P-F	5310-042-9609	WASHER, LOCK MS35335-78 (96906)		EA	REF	*	*	*	*	*	*	*	*		
P-F		SPACER, SLEEVE 541-597-002 (13499)		EA	2	*	*	*	*	*	*	*	*		
P-F		SCREW, MACHINE F325-0062-000 (77250)		EA	4	*	*	*	*	*	*	*	*		
P-F	5310-275-1347	WASHER, FLAT 310-0046-000 (79807)		EA	REF	*	*	*	*	*	*	*	*		
P-F		POST, SPACING 542-7525-002 (13499)		EA	3	*	*	*	*	*	*	*	*		
P-F		POST, SPACING 542-7521-002 (13499)		EA	4	*	*	*	*	*	*	*	*		
P-F		POST, SPACING 542-7522-002 (13499)		EA	3	*	*	*	*	*	*	*	*		
XI-F		PIN, SPRING MS16562-190 (96906)		EA	REF	*	*	*	*	*	*	*	*		
A-F		PANEL, POWER 543-3206-004 (13499)		EA	1	*	*	*	*	*	*	*	*		
X2-F		PANEL, POWER 543-3204-004 (13499)		EA	1	*	*	*	*	*	*	*	*		
P-F		POST, GEAR 545-7747-002 (13499)		EA	1	*	*	*	*	*	*	*	*		
X2-F		SHAFT, SHOULDERED 543-3163-002 (13499)		EA	1	*	*	*	*	*	*	*	*		
P-F		POST, GEAR 545-7748-002 (13499)		EA	1	*	*	*	*	*	*	*	*		
P-F		POST, GEAR 545-7749-002 (13499)		EA	1	*	*	*	*	*	*	*	*		
P-F	33120-725-3852	BEARING, SLEEVE F346-AMILL6085A (70417)		EA	3	*	*	*	*	*	*	*	*	3-3	1AAMP2
P-F	33120-725-3852	BEARING, SLEEVE F346-AMILL6085A (70417)		EA	REF	*	*	*	*	*	*	*	*	3-3	1AAMP4
P-F	33120-725-3852	BEARING, SLEEVE F346-AMILL6085A (70417)		EA	REF	*	*	*	*	*	*	*	*	3-3	1AAMP11
P-F		PIN, SHOULDER, HEADED 543-3096-002 (13499)		EA	4	*	*	*	*	*	*	*	*		
A-F		PLATE ASSEMBLY 543-3097-002 (13499)		EA	2	*	*	*	*	*	*	*	*		
P-F	5310-011-1041	WASHER, LOCK MS35338-79 (96906)		EA	REF	*	*	*	*	*	*	*	*		
P-F	5340-543-3443	SLEEVE, SPRING 340-0641-000 (91314)		EA	2	*	*	*	*	*	*	*	*		
P-F		SCREW, MACHINE F347-0040-000 (77250)		EA	2	*	*	*	*	*	*	*	*		
P-F		BUSHING, CAPTIVE 543-3095-002 (13499)		EA	2	*	*	*	*	*	*	*	*		
X2-F		PLATE, BUSHING 543-3094-002 (13499)		EA	2	*	*	*	*	*	*	*	*		
M-H		LINING, FRICTION 543-3132-002 (13499)		EA	1	*	*	*	*	*	*	*	*		

SECTION III REPAIR PARTS FOR DIRECT SUPPORT, GENERAL SUPPORT, AND DEPOT MAINTENANCE (CONTINUED)

(1) SIC CODE	(2) FEDERAL STOCK NUMBER	(3) DESCRIPTION  USABLE OR CODE	(4) UNIT OF MEAS	(5) QTY REQ IN UNIT	(6) 30-DAY DS MAINT ALLOWANCE			(7) 30-DAY GS MAINT ALLOWANCE			(8) 1 YR ALW PER EQUIP CMTY	(9) DEPOT MAINT ALW PER 100 EQUIP	(10) ILLUSTRATIONS	
					(a) 1-20	(b) 21-50	(c) 51-100	(a) 1-20	(b) 21-50	(c) 51-100			(a) FIG NO.	(b) ITEM NO. OR REFERENCE DESIGNATION
P-F		NUT, CAPTIVE NCR6-1-3 (07786)	EA	6	*	*	*	*	*	*	*			
P-F	3120-725-3851	BEARING, SLEEVE F347-4MILL6089A (70417)	EA	1	*	*	*	*	*	*	*		1A4MP3	
M-H		INSULATION SLEEVING, ELECTRICAL 152-2254-000 (13499)	FT	1										
A-F		PLATE, SWITCH 543-3085-002 (13499)	EA	1										
P-F	3120-725-3852	BEARING, SLEEVE F347-4MILL6089A (70417)	EA	REF	*	*	*	*	*	*	*			
X2-F		PLATE, SWITCH 543-3143-002 (13499)	EA	1										
P-F		POST, DETENT ARM 543-3148-002 (13499)	EA	1	*	*	*	*	*	*	*			
P-F		NUT, CAPTIVE NCR4-1-2 (07886)	EA	6	*	*	*	*	*	*	*			
P-F		ARM, DETENT 543-3084-002 (13499)	EA	1	*	*	*	*	*	*	*			
P-F		ARM, DETENT 543-3147-002 (13499)	EA	1	*	*	*	*	*	*	*			
X2-F		FOLLOWER, DETENT 543-3149-002 (13499)	EA	1										
X2-F		PLATE, HINGE 543-3074-002 (13499)	EA	2										
X2-F		PLATE, HINGE END 543-3071-002 (13499)	EA	2										
X1-F		BUSHING, SLEEVE 543-3141-002 (13499)	EA	2										
X2-F		BLOCK, BEARING 545-7586-002 (13499)	EA	1										
A-F		DIAL, CONTROL 543-3086-002 (13499)	EA	1										
P-F	5315-823-8740	PIN, SPRING MS16562-192 (96906)	EA	1	*	*	*	*	*	*	*			
P-F		HUB-DIAL 543-3145-002 (13499)	EA	1	*	*	*	*	*	*	*	3-3	1A4MP7	
P-F	5820-795-9331	WHEEL-DETENT 543-3146-002 (13499)	EA	1	*	*	*	*	*	*	*	3-3	1A4MP8	
X2-F		SHAFT-SWITCH 543-3150-002 (13499)	EA	1								3-3	1A4MP9	
X2-F		DIAL-SWITCH 543-3152-002 (13499)	EA	1								3-3	1A4DS5	
A-F		GEAR ASSEMBLY, STOP 543-3083-000 (13499)	EA	1								3-3	1A4MP10	
P-F	5340-663-2282	RING, RETAINING 5100-43C (79136)	EA	1	*	*	*	*	*	*	*			
P-F	5820-794-2051	GEAR, SPUR 543-3081-002 (13499)	EA	1	*	*	*	*	*	*	*			
X2-F	5320-117-6010	RIVET, SOLID MS20426AD2-3 (96906)	EA	50										
P-F	5820-794-2042	GEAR, SPUR 543-3109-002 (13499)	EA	1	*	*	*	*	*	*	*			
P-F	5820-794-2044	GAM, PAWL 543-3112-002 (13499)	EA	2	*	*	*	*	*	*	*			

SECTION III REPAIR PARTS FOR DIRECT SUPPORT, GENERAL SUPPORT, AND DEPOT MAINTENANCE (CONTINUED)

(1) SR CODE	(2) FEDERAL STOCK NUMBER	(3) DESCRIPTION  REFERENCE NUMBER & MFR. CODE	(4) UNIT OF MEAS	(5) QTY REQ IN UNIT	(6) 30-DAY DS MAINT ALLOWANCE			(7) 30-DAY GS MAINT ALLOWANCE			(8) 1 YR ALM PER EQUIP ENVTCTY	(9) DEPOT MAINT ALM PER 100 EQUIP	(10) ILLUSTRATIONS	
					(a) 1-20	(b) 21-60	(c) 51-100	(a) 1-20	(b) 21-60	(c) 51-100			(a) FIG NO.	(b) ITEM NO. OR REFERENCE DESIGNATION
X2-F		HUB, STOP GEAR 543-3111-002 (13499)	EA	1										
P-F	5820-794-2052	GEAR, SPUR 543-3082-002 (13499)	EA	1	*	*	*	*	*	*	*			
X2-F	5320-117-6010	PLUET, SOLID MS20426AD2-3 (96906)	EA	REF										
P-F	5820-794-2041	GEAR, SPUR 543-3110-002 (13499)	EA	1	*	*	*	*	*	*	*			
P-F	5820-794-2044	CAM, PAWL 543-3112-002 (13499)	EA	REF	*	*	*	*	*	*	*			
X2-F		PLATE, RETAINING BEARING 543-3072-002 (13499)	EA	1										
P-F	3120-725-3852	BEARING, SLEEVE F346-4MIL16085A (70417)	EA	REF	*	*	*	*	*	*	*			
P-F	5820-787-6034	GEAR, CLUSTER 543-3100-002 (13499)	EA	1	*	*	*	*	*	*	*	3-3	1AAMP12	
P-F		BEARING, SLEEVE 545-7769-002 (13499)	EA	2	*	*	*	*	*	*	*			
P-F	5340-254-4904	RING, RETAINING 5100-37C (79136)	EA	1	*	*	*	*	*	*	*			
X1-F		GEAR, SPUR 543-3167-002 (13499)	EA	1										
P-F	5820-795-5374	GEAR, SPUR-FIXED 543-3168-002 (13499)	EA	1	*	*	*	*	*	*	*			
P-F	5820-795-1537	GEAR, SPUR 543-3169-002 (13499)	EA	1	*	*	*	*	*	*	*			
P-H	5820-537-4835	SPRING-HELICAL 506-2068-002 (13499)	EA	REF				*	*	*	*			
P-F	5820-787-6035	GEAR, SUBASSEMBLY 543-3101-002 (13499)	EA	1	*	*	*	*	*	*	*			
P-F	5315-614-3586	PIN, SPRING MS 16562-212 (96906)	EA	1	*	*	*	*	*	*	*			
X1-F		GEAR, SPUR-DRIVE 543-3102-002 (13499)	EA	1								3-3	1AAMP17	
X1-F		GEAR, SPUR-DRIVE 543-3104-002 (13499)	EA	1										
X1-F		HUB, DRIVE GEAR 543-3105-002 (13499)	EA	1										
X1-F		GEAR, SUBASSEMBLY 543-3103-002 (13499)	EA	1								3-3	1AAMP18	
X1-F		SHAFT, STRAIGHT-DRIVE 543-3106-002 (13499)	EA	1										
X1-F		GEAR, SPUR-STOP 543-3107-002 (13499)	EA	1										
X1-F		GEAR, SPUR-STOP 543-3108-000 (13499)	EA	1										
X1-F		STRIKER, STOP 543-3119-002 (13499)	EA	1										
P-F		SPRING, HELICAL 543-3080-002 (13499)	EA	1	*	*	*	*	*	*	*	3-3	1AAMP19	
P-F		INSULATION SLEEVING, ELECTRICAL TEFTW22B (81851)	FT	19	*	*	*	*	*	*	*			
P-F	5305-792-2294	SCREW, SPECIAL 543-3144-002 (13499)	EA	1	*	*	*	*	*	*	*			

SECTION III REPAIR PARTS FOR DIRECT SUPPORT, GENERAL SUPPORT, AND DEPOT MAINTENANCE (CONTINUED)

(1) SRC CODE	(2) FEDERAL STOCK NUMBER	(3) DESCRIPTION	USABLE ON CODE	(4) UNIT OF MEAS	(5) QTY INC IN UNIT	(6) 30-DAY DS MAINT ALLOWANCE			(7) 30-DAY GS MAINT ALLOWANCE			(8) 1 YR ALW PER EQUIP CMTGTY	(9) DEPOT MAINT ALW PER 100 EQUIP	(10) ILLUSTRATIONS	
						(a)	(b)	(c)	(a)	(b)	(c)			(a)	(b)
						1-20	21-50	51-100	1-20	21-50	51-100			FIG NO.	ITEM NO. OR REFERENCE DESIGNATION
P-F	5820-788-2638	GUIDE, DETENT 543-3151-002 (13499)		EA	1	*	*	*	*	*	*	*	*		
XI-F		POST, PAWL 543-3115-002 (13499)		EA	1										
X2-F		SHAFT, STRAIGHT-LINE 545-7584-002 (13499)		EA	1										
P-F		SHIM 545-3191-002 (13499)		EA	1	*	*	*	*	*	*	*	*		
A-F		PAWL AND LIFTER 543-3118-002 (13499)		EA	1										
XI-F		PAWL 543-3116-002 (13499)		EA	1										
XI-F		LIFTER, PAWL 543-3117-002 (13499)		EA	1										
P-F		SHAFT, SHOULDERED-STOP GEAR 543-3113-002 (13499)		EA	1	*	*	*	*	*	*	*	*	3-3	1A4MP22
P-F		GUIDE, PAWL 543-3114-002 (13499)		EA	1	*	*	*	*	*	*	*	*		
P-F	5820-788-2634	GEAR, CLUSTER 543-3178-002 (13499)		EA	1	*	*	*	*	*	*	*	*	3-3	1A4MP23
XI-F		BEARING, SLEEVE A205-1M116085 (70417)		EA	1										
XI-F		GEAR, SPUR-COMP 543-3176-002 (13499)		EA	1										
XI-F		GEAR, BEVEL 543-3177-002 (13499)		EA	1										
P-F	3020-788-2642	GEAR, SPUR 545-7740-002 (13499)		EA	1	*	*	*	*	*	*	*	*		
P-F	5310-011-1041	WASHER, LOCK MS35338-79 (96906)		EA	REF	*	*	*	*	*	*	*	*		
P-F	3020-787-8291	GEAR, SPUR 545-7743-002 (13499)		EA	1	*	*	*	*	*	*	*	*	3-3	1A4MP27
P-F	1430-956-4907	BEARING, BALL ANNULAR SS77R3XR1E (43334)		EA	4	*	*	*	*	*	*	*	*	3-3	1A4MP28
P-F	1430-956-4907	BEARING, BALL, ANNULAR SS77R3XR1E (43334)		EA	REF	*	*	*	*	*	*	*	*	3-3	1A4MP34
XI-F		GEAR, SPUR 545-7744-002 (13499)		EA	1										
P-F		POST, GEAR 545-7741-002 (13499)		EA	1	*	*	*	*	*	*	*	*		
P-F		ACTUATOR, BRAKE 543-3136-002 (13499)		EA	1	*	*	*	*	*	*	*	*	3-3	1A4MP29
P-F		SCREW, MACHINE P343-0329-000 (77250)		EA	24	*	*	*	*	*	*	*	*		
P-H	5340-020-3153	DISCONNECT, PRESSURE 756-3264-003 (13499)		EA	1				*	*	*	*	*		
P-F	5820-788-2637	GEAR, CLUSTER 543-3162-002 (13499)		EA	1	*	*	*	*	*	*	*	*	3-3	1A4MP30
XI-F		GEAR, SPUR 543-3159-002 (13499)		EA	1										
XI-F		GEAR, SPUR 543-3160-002 (13499)		EA	1										
XI-F		GEAR, SPUR 543-3161-002 (13499)		EA	1										

SECTION III REPAIR PARTS FOR DIRECT SUPPORT, GENERAL SUPPORT, AND DEPOT MAINTENANCE (CONTINUED)

(1) SRR CODE	(2) FEDERAL STOCK NUMBER	(3) DESCRIPTION  REFERENCE NUMBER & MFR. CODE	(4) UNIT OF MEAS	(5) QTY INC IN UNIT	(6) 30-DAY DS MAINT ALLOWANCE			(7) 30-DAY GS MAINT ALLOWANCE			(8) 1 YR ALW PER EQUIP CMTY	(9) DEPOT MAINT ALW PER 100 EQUIP	(10) ILLUSTRATIONS	
					(a) 1-20	(b) 21-50	(c) 51-100	(a) 1-20	(b) 21-50	(c) 51-100			(a) FIG NO.	(c) ITEM NO. OR REFERENCE DESIGNATION
P-F		SPRING, HELICAL 543-3165-002 (13499)	EA	1	*	*	*	*	*	*	*	3-3	1A4MP31	
P-F		SPRING, HELICAL 543-3166-002 (13499)	EA	1	*	*	*	*	*	*	*	3-3	1A4MP32	
P-F	5310-167-0847	WASHER, LOCK AN936B6B (88044)	EA	19	*	*	*	*	*	*	*			
P-F		POST-GEAR 545-7746-002 (13499)	EA	1	*	*	*	*	*	*	*			
P-F	5820-787-8292	GEAR-SPUR 545-7745-002 (13499)	EA	1	*	*	*	*	*	*	*	3-3	1A4MP33	
P-F	1430-956-4907	BEARING, BALL ANNULAR SS77R3XRIE (43334)	EA	REF	*	*	*	*	*	*	*			
X1-F		GEAR, SPUR 545-7742-002 (13499)	EA	1	*	*	*	*	*	*	*			
X2-F		COUNTER, FIXED 015-0681-000 (13499)	EA	1	*	*	*	*	*	*	*	3-3	1A4MP	
P-F		NUT, PLAIN, HEXAGON P313-014G-000 (77250)	EA	20	*	*	*	*	*	*	*			
P-F		TERMINAL, LUG 4007-6HOTFINNED (77147)	EA	REF	*	*	*	*	*	*	*			
M-H		WIRE, ELECTRICAL 00702-1322 (70567)	FT	REF	*	*	*	*	*	*	*			
P-F		POST, SPACING 542-7523-002 (13499)	EA	REF	*	*	*	*	*	*	*			
P-F		SHIM 543-3180-002 (13499)	EA	13	*	*	*	*	*	*	*			
P-F		WASHER 500-1084-003 (13499)	EA	3	*	*	*	*	*	*	*			
P-F		SHIM 543-3181-002 (13499)	EA	4	*	*	*	*	*	*	*			
P-F		SCREW, MACHINE 330-2411-000 (13499)	EA	2	*	*	*	*	*	*	*			
P-F	5355-817-7933	KNOB 1450BZBLK (72512)	EA	1	*	*	*	*	*	*	*			
P-F		WASHER, LOCK 310-3340-000 (79807)	EA	1	*	*	*	*	*	*	*			
P-F	5305-055-7108	SCREW, CAPTIVE SOCKET HEAD B2A440-4C3 (08664)	EA	61	*	*	*	*	*	*	*			
P-F		SCREW, CAPTIVE 324-1682-070 (13499)	EA	61	*	*	*	*	*	*	*			
P-F	5820-787-6043	GEAR, BEVEL 543-3138-002 (13499)	EA	1	*	*	*	*	*	*	*			
P-F		WASHER 541-1200-003 (13499)	EA	1	*	*	*	*	*	*	*			
P-F		WASHER 543-5582-003 (13499)	EA	1	*	*	*	*	*	*	*			
X2-F		CLAMP, BEVEL 544-6037-002 (13499)	EA	1	*	*	*	*	*	*	*	3-3	1A4MP79	
P-F	5340-634-7444	RING, RETAINING MS16632-1018 (96906)	EA	REF	*	*	*	*	*	*	*			
P-F		SPRING, HELICAL 544-9804-002 (13499)	EA	1	*	*	*	*	*	*	*			
P-F		SETScrew 335-0041-000 (08664)	EA	22	*	*	*	*	*	*	*			
P-H		BEARING, BALL, ANNULAR S6632FCHP37L02 (40920)	EA	REF	*	*	*	*	*	*	*			
P-F		SETScrew 4-48X1-86SPLINEOVRT18-8SST (08664)	EA	REF	*	*	*	*	*	*	*			
P-F		RETAINER, BEARING 545-7585-002 (13499)	EA	2	*	*	*	*	*	*	*			
P-F		WASHER 542-7475-003 (13499)	EA	3	*	*	*	*	*	*	*			
P-F	5340-282-6296	RING, RETAINING 5555-18MD (79136)	EA	1	*	*	*	*	*	*	*			
A-F		PLENUM STABILIZER 543-3217-005 (13499)	EA	1	*	*	*	*	*	*	*			
X2-F		PLENUM STABILIZER 543-3216-005 (13499)	EA	1	*	*	*	*	*	*	*			



SECTION III REPAIR PARTS FOR DIRECT SUPPORT, GENERAL SUPPORT, AND DEPOT MAINTENANCE (CONTINUED)

(1) S/R CODE	(2) FEDERAL STOCK NUMBER	(3) DESCRIPTION	USABLE ON CODE	(4) UNIT OF MEAS	(5) QTY INC IN UNIT	(6) 30-DAY DS MAINT ALLOWANCE			(7) 30-DAY GS MAINT ALLOWANCE			(8) 1 YR ALW PER EQUIP CATGCT	(9) DEPOT MAINT ALW PER 100 EQUIP	(10) ILLUSTRATIONS	
						(a)	(b)	(c)	(a)	(b)	(c)			(a)	(b)
						1-20	21-50	51-100	1-20	21-50	51-100			FIG NO.	ITEM NO. OR REFERENCE DESIGNATION
P-F		NUT, CAPTIVE MCM6-2-2-1 (07886)		EA	REF	*	*	*	*	*	*	*	*		
P-F		SCREW, MACHINE P347-0024-000 (77250)		EA	8	*	*	*	*	*	*	*	*		
P-F	5910-615-4101	CAPACITOR, FIXED, CERAMIC DIELECTRIC 327-029X3T0102Z (72982)		EA	19	*	*	*	*	*	*	*	*	3-2	1A4C1
P-F	5910-615-4101	CAPACITOR, FIXED, CERAMIC DIELECTRIC 327-029X3T0102Z (72982)		EA	REF	*	*	*	*	*	*	*	*	3-2	1A4C2
P-F	5910-615-4101	CAPACITOR, FIXED, CERAMIC DIELECTRIC 327-029X3T0102Z (72982)		EA	REF	*	*	*	*	*	*	*	*	3-2	1A4C3
P-F	5910-615-4101	CAPACITOR, FIXED, CERAMIC DIELECTRIC 327-029X3T0102Z (72982)		EA	REF	*	*	*	*	*	*	*	*	3-2	1A4C4
P-F	5910-615-4101	CAPACITOR, FIXED, CERAMIC DIELECTRIC 327-029X3T0102Z (72982)		EA	REF	*	*	*	*	*	*	*	*	3-2	1A4C5
P-F	5910-615-4101	CAPACITOR, FIXED, CERAMIC DIELECTRIC 327-029X3T0102Z (72982)		EA	REF	*	*	*	*	*	*	*	*	3-2	1A4C6
P-F	5910-615-4101	CAPACITOR, FIXED, CERAMIC DIELECTRIC 327-029X3T0102Z (72982)		EA	REF	*	*	*	*	*	*	*	*	3-2	1A4C7
P-F	5910-615-4101	CAPACITOR, FIXED, CERAMIC DIELECTRIC 327-029X3T0102Z (72982)		EA	REF	*	*	*	*	*	*	*	*	3-2	1A4C8
P-F	5910-615-4101	CAPACITOR, FIXED, CERAMIC DIELECTRIC 327-029X3T0102Z (72982)		EA	REF	*	*	*	*	*	*	*	*	3-2	1A4C9
P-F	5910-615-4101	CAPACITOR, FIXED, CERAMIC DIELECTRIC 327-029X3T0102Z (72982)		EA	REF	*	*	*	*	*	*	*	*	3-2	1A4C10
P-F	5910-615-4101	CAPACITOR, FIXED, CERAMIC DIELECTRIC 327-029X3T0102Z (72982)		EA	REF	*	*	*	*	*	*	*	*	3-2	1A4C11
P-F	5910-615-4101	CAPACITOR, FIXED, CERAMIC DIELECTRIC 327-029X3T0102Z (72982)		EA	REF	*	*	*	*	*	*	*	*	3-2	1A4C12
P-F	5910-615-4101	CAPACITOR, FIXED, CERAMIC DIELECTRIC 327-029X3T0102Z (72982)		EA	REF	*	*	*	*	*	*	*	*	3-2	1A4C13
P-F	5910-615-4101	CAPACITOR, FIXED, CERAMIC DIELECTRIC 327-029X3T0102Z (72982)		EA	REF	*	*	*	*	*	*	*	*	3-2	1A4C14
P-F	5910-615-4101	CAPACITOR, FIXED, CERAMIC DIELECTRIC 327-029X3T0102Z (72982)		EA	REF	*	*	*	*	*	*	*	*	3-2	1A4C15
P-F	5910-615-4101	CAPACITOR, FIXED, CERAMIC DIELECTRIC 327-029X3T0102Z (72982)		EA	REF	*	*	*	*	*	*	*	*	3-2	1A4C16
P-F	5910-615-4101	CAPACITOR, FIXED, CERAMIC DIELECTRIC 327-029X3T0102Z (72982)		EA	REF	*	*	*	*	*	*	*	*	3-2	1A4C17
P-F	5910-615-4101	CAPACITOR, FIXED, CERAMIC DIELECTRIC 327-029X3T0102Z (72982)		EA	REF	*	*	*	*	*	*	*	*	3-2	1A4C18
P-F	5910-615-4101	CAPACITOR, FIXED, CERAMIC DIELECTRIC 327-029X3T0102Z (72982)		EA	REF	*	*	*	*	*	*	*	*	3-2	1A4C19
P-F	5305-054-6652	SCREW, MACHINE MS11927-28 (96906)		EA	REF	*	*	*	*	*	*	*	*		
P-F		WASHER, FLAT 310-6360-000 (79807)		EA	64	*	*	*	*	*	*	*	*		
P-F	5310-857-5547	NUT, SELF-LOCKING, HEXAGON MS21044D06 (96906)		EA	7	*	*	*	*	*	*	*	*		
P-F	5340-205-4731	RING, RETAINING MS16633-1009 (96906)		EA	22	*	*	*	*	*	*	*	*		
P-F		NUT, PLAIN, HEXAGON MS35699-64 (96906)		EA	74	*	*	*	*	*	*	*	*		
M-H		INSULATION SLEEVING, ELECTRICAL XF12BL (81851)		FT	2										
P-F	5905-247-8732	RESISTOR, FIXED, COMPOSITION RC32GF471K (81349)		EA	4	*	*	*	*	*	*	*	*	3-3	1A4R1
P-F	5905-247-8732	RESISTOR, FIXED, COMPOSITION RC32GF4 (81349)		EA	REF	*	*	*	*	*	*	*	*	3-3	1A4R2
P-F	5905-247-8732	RESISTOR, FIXED, COMPOSITION RC32GF471K (81349)		EA	REF	*	*	*	*	*	*	*	*		1A4R3
P-F	5905-247-8732	RESISTOR, FIXED, COMPOSITION RC32GF471K (81349)		EA	REF	*	*	*	*	*	*	*	*		1A4R4
P-F	5905-106-1273	RESISTOR, FIXED, COMPOSITION RC20GF153J (81349)		EA	1	*	*	*	*	*	*	*	*	3-2	1A4R5
P-F	5950-679-9345	COIL, RADIO FREQUENCY 240-0272-000 (95105)		EA	2	*	*	*	*	*	*	*	*	3-2	1A4L1

SECTION III REPAIR PARTS FOR DIRECT SUPPORT, GENERAL SUPPORT, AND DEPOT MAINTENANCE (CONTINUED)

(1) S&C CODE	(2) FEDERAL STOCK NUMBER	(3) DESCRIPTION  REFERENCE NUMBER & MFR. CODE	(4) UNIT OF MEAS	(5) QTY INC IN UNIT	(6) 30-DAY DS MAINT ALLOWANCE			(7) 30-DAY GS MAINT ALLOWANCE			(8) 1 YR ALW PER EQUIP CNTGCTY	(9) DEPOT MAINT ALW PER 100 EQUIP	(10) ILLUSTRATIONS				
					USABLE ON CODE	REF	*	*	*	*			*	*	*	(a) FIG NO.	(b) ITEM NO. OR REFERENCE DESIGNATION
P-F	5950-679-9345	COIL, RADIO FREQUENCY 240-0272-000 (95105)	EA	REF	*	*	*	*	*	*	*	*	3-2	1A4L17			
P-F	5910-949-7366	CAPACITOR, FIXED, PAPER DIELECTRIC SDA3K01334K (53021)	EA	2	*	*	*	*	*	*	*	*	3-2	1A4C34			
P-F	5910-949-7366	CAPACITOR, FIXED, PAPER DIELECTRIC SDA3K01334K (53021)	EA	REF	*	*	*	*	*	*	*	*	3-2	1A4C43			
P-F	5945-542-7041	RELAY, ARMATURE 95-2943 (04221)	EA	2	*	*	*	*	*	*	*	*	3-2	1A4K1			
P-F	5910-803-2882	CAPACITOR, FIXED, PAPER DIELECTRIC C224BKB224 (81349)	EA	7	*	*	*	*	*	*	*	*	3-2	1A4C21			
P-F	5910-803-2882	CAPACITOR, FIXED, PAPER DIELECTRIC C224BKB224 (81349)	EA	REF	*	*	*	*	*	*	*	*	3-2	1A4C22			
P-F	5910-803-2882	CAPACITOR, FIXED, PAPER DIELECTRIC C224BKB224 (81349)	EA	REF	*	*	*	*	*	*	*	*	3-2	1A4C29			
P-F	5910-803-2882	CAPACITOR, FIXED, PAPER DIELECTRIC C224BKB224 (81349)	EA	REF	*	*	*	*	*	*	*	*	3-2	1A4C30			
P-F	5910-803-2882	CAPACITOR, FIXED, PAPER DIELECTRIC C224BKB224 (81349)	EA	REF	*	*	*	*	*	*	*	*	3-2	1A4C33			
P-F	5910-803-2882	CAPACITOR, FIXED, PAPER DIELECTRIC C224BKB224 (81349)	EA	REF	*	*	*	*	*	*	*	*	3-2	1A4C37			
P-F	5910-803-2882	CAPACITOR, FIXED, PAPER DIELECTRIC C224BKB224 (81349)	EA	REF	*	*	*	*	*	*	*	*	3-2	1A4C40			
P-F	5910-803-2882	CAPACITOR, FIXED, MICA DIELECTRIC CM07F20303 (81349)	EA	1	*	*	*	*	*	*	*	*	3-17	1A4C45			
P-F		TERMINAL, LUG 4007-4HOTINNED (77147)	EA	32	*	*	*	*	*	*	*	*					
P-F	5910-556-1425	CAPACITOR, FIXED, CERAMIC DIELECTRIC 33C2 (01939)	EA	3	*	*	*	*	*	*	*	*	3-2	1A4C41			
P-F	1910-556-1425	CAPACITOR, FIXED, CERAMIC DIELECTRIC 33C2 (01939)	EA	REF	*	*	*	*	*	*	*	*	3-2	1A4C42			
P-F	1910-556-1425	CAPACITOR, FIXED, CERAMIC DIELECTRIC 33C2 (01939)	EA	REF	*	*	*	*	*	*	*	*	3-2	1A4C44			
P-F	5950-796-3120	COIL, RADIO FREQUENCY 18-1117 (09250)	EA	4	*	*	*	*	*	*	*	*	3-2	1A4L3			
P-F	5950-796-3120	COIL, RADIO FREQUENCY 18-1117 (09250)	EA	REF	*	*	*	*	*	*	*	*	3-2	1A4L5			
P-F	5950-796-3120	COIL, RADIO FREQUENCY 18-1117 (09250)	EA	REF	*	*	*	*	*	*	*	*	3-2	1A4L8			
P-F	5950-796-3120	COIL, RADIO FREQUENCY 18-1117 (09250)	EA	REF	*	*	*	*	*	*	*	*	3-2	1A4L11			
P-F	5950-796-3120	COIL, RADIO FREQUENCY 2500-42 (99800)	EA	4	*	*	*	*	*	*	*	*	3-2	1A4L3			
P-F	5950-796-3120	COIL, RADIO FREQUENCY 2500-42 (99800)	EA	REF	*	*	*	*	*	*	*	*	3-2	1A4L5			
P-F	5950-796-3120	COIL, RADIO FREQUENCY 2500-42 (99800)	EA	REF	*	*	*	*	*	*	*	*	3-2	1A4L8			
P-F	5950-796-3120	COIL, RADIO FREQUENCY 2500-42 (99800)	EA	REF	*	*	*	*	*	*	*	*	3-2	1A4L11			
P-F	5950-991-3367	COIL, RADIO FREQUENCY LT7K205 (81349)	EA	5	*	*	*	*	*	*	*	*	3-2	1A4L4			
P-F	5950-991-3367	COIL, RADIO FREQUENCY LT7K205 (81349)	EA	REF	*	*	*	*	*	*	*	*	3-2	1A4L6			
P-F	5950-991-3367	COIL, RADIO FREQUENCY LT7K205 (81349)	EA	REF	*	*	*	*	*	*	*	*	3-2	1A4L7			
P-F	5950-991-3367	COIL, RADIO FREQUENCY LT7K205 (81349)	EA	REF	*	*	*	*	*	*	*	*	3-2	1A4L9			
P-F	5950-991-3367	COIL, RADIO FREQUENCY LT7K205 (81349)	EA	REF	*	*	*	*	*	*	*	*	3-2	1A4L10			
P-F	5950-823-3222	COIL, RADIO FREQUENCY LT7K210 (81349)	EA	2	*	*	*	*	*	*	*	*	3-2	1A4L12			
P-F	5950-823-3222	COIL, RADIO FREQUENCY LT7K210 (81349)	EA	REF	*	*	*	*	*	*	*	*	3-2	1A4L13			
P-F	5305-054-6650	SCREW, MACHINE MS51957-26 (96906)	EA	2	*	*	*	*	*	*	*	*					

SECTION III REPAIR PARTS FOR DIRECT SUPPORT, GENERAL SUPPORT, AND DEPOT MAINTENANCE (CONTINUED)

(1) SQR CODE	(2) FEDERAL STOCK NUMBER	(3) DESCRIPTION  REFERENCE NUMBER & MFR. CODE	(4) UNIT OF MEAS	(5) QTY INC IN UNIT	(6) 30-DAY DS MAINT ALLOWANCE			(7) 30-DAY GS MAINT ALLOWANCE			(8) 1 YR ALW PER EQUIP CNTCTY	(9) DEPOT MAINT ALW PER 100 EQUIP	(10) ILLUSTRATIONS	
					(a) 1-20	(b) 21-50	(c) 51-100	(a) 1-20	(b) 21-50	(c) 51-100			(a) FIG NO.	(b) ITEM NO. OR REFERENCE DESIGNATION
P-F	5305-763-7822	SCREW, MACHINE MS51959-14 (96906)	EA	49	*	*	*	*	*	*	*			
P-F		TERMINAL, STUD 2B10B12 (92825)	EA	7	*	*	*	*	*	*	*	3-2	1A4E5	
P-F		TERMINAL, STUD 2B10B12 (92825)	EA	REF	*	*	*	*	*	*	*	3-2	1A4E6	
P-F		TERMINAL, STUD 2B10B12 (92825)	EA	REF	*	*	*	*	*	*	*	3-2	1A4E7	
P-F		TERMINAL, STUD 2B10B12 (92825)	EA	REF	*	*	*	*	*	*	*	3-2	1A4E8	
P-F		TERMINAL, STUD 2B10B12 (92825)	EA	REF	*	*	*	*	*	*	*	3-2	1A4E9	
P-F		TERMINAL, STUD 2B10B12 (92825)	EA	REF	*	*	*	*	*	*	*	3-2	1A4E10	
P-F		TERMINAL, STUD 2B10B12 (92825)	EA	REF	*	*	*	*	*	*	*	3-2	1A4E11	
P-F		TERMINAL, STUD 2A1DB12 (92825)	EA	2	*	*	*	*	*	*	*	3-2	1A4E13	
P-F		TERMINAL, STUD 2A1DB12 (92825)	EA	REF	*	*	*	*	*	*	*	3-2	1A4E14	
X2-F		BRACKET, CAPACITOR 543-6260-002 (13499)	EA	1										
X2-F		BRACKET, CAPACITOR 543-6261-002 (13499)	EA	1										
X2-F		BRACKET, ANGLE 543-6259-002 (13499)	EA	1										
X2-F		PANEL, EDGE LITE 544-6034-003 (13499)	EA	1										
P-F	5305-777-6039	SCREW, MACHINE MS51959-12 (96906)	EA	REF	*	*	*	*	*	*	*			
P-F	5310-934-9748	NUT, PLAIN, HEXAGON MS39649-44 (96906)	EA	43	*	*	*	*	*	*	*			
P-F	5935-204-7705	CONNECTOR, RECEPTACLE, ELECTRICAL 26-4401-16S (02660)	EA	1	*	*	*	*	*	*	*	3-2	1A4J17	
P-F	5935-296-8720	CONNECTOR, RECEPTACLE, ELECTRICAL 26-4403-16S (02660)	EA	1	*	*	*	*	*	*	*	3-2	1A4J16	
P-F	5310-183-4354	WASHER, FLAT 506-7367-002 (13499)	EA	28	*	*	*	*	*	*	*			
P-F		TERMINAL, LDG 2110-04-00BOTTINNED (78189)	EA	3	*	*	*	*	*	*	*			
P-F		TERMINAL, LDG 2110-06-00BOTTINNED (78189)	EA	1	*	*	*	*	*	*	*			
M-R		CLAMP, LOOP HP6N (09922)	EA	8										
M-R		CLAMP, LOOP HP4N (09922)	EA	6										
M-R		CLAMP, LOOP HP7N (09922)	EA	5										
M-R		WIRE, ELECTRICAL 00702-1320 (70567)	FT	38										
M-R		WIRE, ELECTRICAL 00702-1322 (70567)	FT	REF										
M-R		WIRE, ELECTRICAL 00702-1326 (70567)	FT	11										

SECTION III REPAIR PARTS FOR DIRECT SUPPORT, GENERAL SUPPORT, AND DEPOT MAINTENANCE (CONTINUED)

(1) SIC CODE	(2) FEDERAL STOCK NUMBER	(3) DESCRIPTION  REFERENCE NUMBER & MFR. CODE	(4) UNIT OF MEAS	(5) QTY INC IN UNIT	(6) 30-DAY DS MAINT ALLOWANCE			(7) 30-DAY GS MAINT ALLOWANCE			(8) 1 YR ALW PER EQUIP CATGCT	(9) DEPOT MAINT ALW PER 100 EQUIP	(10) ILLUSTRATIONS	
					(a) 1-20	(b) 21-50	(c) 51-100	(a) 1-20	(b) 21-50	(c) 51-100			(a) FIG NO.	(b) ITEM NO. OR REFERENCE DESIGNATION
M-H		CABLE, RADIO FREQUENCY RG196AU (80058)	FT	REF										
M-H		WIRE, ELECTRICAL MILW16878TYPE22-9 (81349)	FT	REF										
M-H		WIRE, ELECTRICAL MILW16878TYPE22-90 (81349)	FT	REF										
M-H		WIRE, ELECTRICAL MILW16878TYPE22-91 (81349)	FT	REF										
M-H		WIRE, ELECTRICAL MILW16878TYPE22-92 (81349)	FT	REF										
M-H		WIRE, ELECTRICAL MILW16878TYPE22-93 (81349)	FT	REF										
M-H		WIRE, ELECTRICAL MILW16878TYPE22-95 (81349)	FT	REF										
M-H		WIRE, ELECTRICAL MILW16878TYPE22-96 (81349)	FT	REF										
M-H		WIRE, ELECTRICAL MILW16878TYPE22-902 (81349)	FT	REF										
M-H		WIRE, ELECTRICAL MILW16878TYPE22-903 (81349)	FT	REF										
M-H		WIRE, ELECTRICAL MILW16878TYPE22-905 (81349)	FT	REF										
M-H		WIRE, ELECTRICAL MILW16878TYPE22-906 (81349)	FT	REF										
M-H		WIRE, ELECTRICAL MILW16878TYPE22-912 (81349)	FT	REF										
M-H		WIRE, ELECTRICAL MILW16878TYPE22-913 (81349)	FT	REF										
M-H		WIRE, ELECTRICAL MILW16878TYPE22-915 (81349)	FT	REF										
M-H		WIRE, ELECTRICAL MILW16878TYPE22-916 (81349)	FT	REF										
M-H		WIRE, ELECTRICAL MILW16878TYPE22-923 (81349)	FT	23										
M-H		WIRE, ELECTRICAL MILW16878TYPE22-925 (81349)	FT	22										
M-H		WIRE, ELECTRICAL MILW16878TYPE22-926 (81349)	FT	REF										
M-H		WIRE, ELECTRICAL MILW16878TYPE22-935 (81349)	FT	REF										
M-H		WIRE, ELECTRICAL MILW16878TYPE22-936 (81349)	FT	REF										
M-H		WIRE, ELECTRICAL MILW16878TYPE22-902-5 (81349)	FT	REF										
M-H		WIRE, ELECTRICAL MILW16878TYPE22-902-6 (81349)	FT	REF										
M-H		WIRE, ELECTRICAL SUB734M90 (90484)	FT	1										
M-H		WIRE, ELECTRICAL SUB734M91 (90484)	FT	1										
M-H		WIRE, ELECTRICAL SUB734M95 (90484)	FT	1										
M-H		WIRE, ELECTRICAL SUB734M915 (90484)	FT	1										

SECTION III REPAIR PARTS FOR DIRECT SUPPORT, GENERAL SUPPORT, AND DEPOT MAINTENANCE (CONTINUED)

(1) 308 CODE	(2) FEDERAL STOCK NUMBER	(3) DESCRIPTION  USABLE ON CODE	(4) UNIT OF MEAS	(5) QTY INC IN UNIT	(6) 30-DAY DS MAINT ALLOWANCE			(7) 30-DAY GS MAINT ALLOWANCE			(8) 1 YR ALW PER EQUIP CNTGTY	(9) DEPOT MAINT ALW PER 100 EQUIP	(10) ILLUSTRATIONS	
					(a)	(b)	(c)	(a)	(b)	(c)			(a) FIG NO.	(b) ITEM NO. OR REFERENCE DESIGNATION
					1-20	21-50	51-100	1-20	21-50	51-100				
P-F		SETScrew 328-0024-000 (08664)	EA	2	*	*	*	*	*	*	*	*		
XI-H		COLLAR, SHAFT 503-3774-002 (13499)	EA	1										
P-F		SETScrew 4-48X1-86SPLINE416SST (08665)	EA	5	*	*	*	*	*	*	*	*		
XI-H		PULLEY, STAKED 543-3075-002 (13499)	EA	REF										
P-F		WASHER, PULLEY 542-7483-003 (13499)	EA	REF	*	*	*	*	*	*	*	*		
P-H		BEARING, BALL, ANNULAR 56632FCHP37L02 (40920)	EA	REF	*	*	*	*	*	*	*	*		
P-F		RETAINER, BEARING 545-7585-002 (13499)	EA	REF	*	*	*	*	*	*	*	*		
P-F		SETScrew 4-48X1-86SPLINEOVPT18-8SST (02664)	EA	REF	*	*	*	*	*	*	*	*		
P-F		NUT, FLAIN, HEXAGON P-313-0045-000 (77250)	EA	REF	*	*	*	*	*	*	*	*		
P-F	5821-657-0429	BUTTON, STAKED 541-5177-002 (13499)	EA	4	*	*	*	*	*	*	*	*		
P-F		SCREW, MACHINE P343-0286-000 (77250)	EA	44	*	*	*	*	*	*	*	*		
P-F	5910-552-9868	CAPACITOR, FIXED, PAPER DIELECTRIC NFTHEP1L (14655)	EA	9	*	*	*	*	*	*	*	*	3-2	1A4C23
P-F	5910-552-9868	CAPACITOR, FIXED, PAPER DIELECTRIC NFTHEP1L (14655)	EA	REF	*	*	*	*	*	*	*	*	3-2	1A4C25
P-F	5910-552-9868	CAPACITOR, FIXED, PAPER DIELECTRIC NFTHEP1L (14655)	EA	REF	*	*	*	*	*	*	*	*	3-2	1A4C26
P-F	5910-552-9868	CAPACITOR, FIXED, PAPER DIELECTRIC NFTHEP1L (14655)	EA	REF	*	*	*	*	*	*	*	*	3-2	1A4C28
P-F	5910-552-9868	CAPACITOR, FIXED, PAPER DIELECTRIC NFTHEP1L (14655)	EA	REF	*	*	*	*	*	*	*	*	3-2	1A4C31
P-F	5910-552-9868	CAPACITOR, FIXED, PAPER DIELECTRIC NFTHEP1L (14655)	EA	REF	*	*	*	*	*	*	*	*	3-2	1A4C32
P-F	5910-552-9868	CAPACITOR, FIXED, PAPER DIELECTRIC NFTHEP1L (14655)	EA	REF	*	*	*	*	*	*	*	*	3-2	1A4C35
P-F	5910-552-9868	CAPACITOR, FIXED, PAPER DIELECTRIC NFTHEP1L (14655)	EA	REF	*	*	*	*	*	*	*	*	3-2	1A4C36
P-F	5910-552-9868	CAPACITOR, FIXED, PAPER DIELECTRIC NFTHEP1L (14655)	EA	REF	*	*	*	*	*	*	*	*	3-2	1A4C38
X2-F		PLATE, COVER 554-4811-003 (13499)	EA	1										
XI-F		PLATE, COVER 554-4810-003 (13499)	EA	1										
P-F	5310-969-6092	NUT, SELF-LOCKING, CLINCH F12NCPM1-82 (72962)	EA	4	*	*	*	*	*	*	*	*		
P-F	5305-579-3511	SCREW, MACHINE MS35216-42 (96906)	EA	5	*	*	*	*	*	*	*	*		
P-F	5305-764-0068	SCREW, MACHINE MS31959-45 (96906)	EA	2	*	*	*	*	*	*	*	*		
M-H		CLAMP, LOOP HP3W (09922)	EA	17										
P-H	5820-672-6312	FREQUENCY DIVIDER 542-7697-004 (13499)	EA	1				*	*	*	*	*	3-4	1A4A1

SECTION III REPAIR PARTS FOR DIRECT SUPPORT, GENERAL SUPPORT, AND DEPOT MAINTENANCE (CONTINUED)

(1) SR CODE	(2) FEDERAL STOCK NUMBER	(3) DESCRIPTION  USABLE ON CODE	(4) UNIT OF MEAS	(5) QTY INC IN UNIT	(6) 30-DAY DS MAINT ALLOWANCE			(7) 30-DAY GS MAINT ALLOWANCE			(8) 1 YR ALM PER EQUIP CNTGTY	(9) DEPOT MAINT ALM PER 100 EQUIP	(10) ILLUSTRATIONS	
					(a) 1-20	(b) 21-50	(c) 51-100	(a) 1-20	(b) 21-50	(c) 51-100			(a) FIG NO.	(b) ITEM NO. OR REFERENCE DESIGNATION
X2-H		PLATE, COVER 549-4448-003 (13499)	EA	1										
X2-H		PLATE, COVER 542-7696-003 (13499)	EA	18										
P-H		WASHER, LOCK 310-0076-000 (79807)	EA	153				*	*	*	*	*		
P-H		WASHER 506-5902-003 (13499)	EA	17				*	*	*	*	*		
P-F	5305-777-6039	SCREW, MACHINE MS91959-12 (96906)	EA	REF	*	*	*	*	*	*	*	*		
P-H	5305-616-2568	SCREW, MACHINE P343-0285-000 (77250)	EA	48				*	*	*	*	*		
M-H		WIRE, ELECTRICAL MILW16878TTP22-9 (81349)	FT	12										
X2-H		PLATE, BASE 542-7684-002 (13499)	EA	1										
P-H		PIN, LOCATING 541-6556-002 (13499)	EA	10				*	*	*	*	*		
X2-H		PLATE, BASE DIVIDER 542-7693-003 (13499)	EA	1										
X2-H		PLATE-CASTING 543-1494-014 (13499)	EA	8										
X2-H		FRAME, CHASSIS 542-7735-002 (13499)	EA	1										
X2-H		FRAME, CHASSIS 542-7736-003 (13499)	EA	1										
X2-H	5320-117-6010	RIVET, SOLID MS20426A12-3 (96906)	EA	REF										
P-H		BRACKET, SCREW 542-7768-002 (13499)	EA	21				*	*	*	*	*		
A-H		CHASSIS, BOARD 542-7687-002 (13499)	EA	1										
P-H		NUT, PLAIN 542-7709-002 (13499)	EA	10				*	*	*	*	*		
X2-H		CHASSIS, ELECTRICAL 542-7690-003 (13499)	EA	1										
P-H	5310-141-1813	NUT, PLAIN, CLINCH CL440-1C (46384)	EA	16				*	*	*	*	*		
P-H		NUT, PLAIN CL440-1C (46384)	EA	16				*	*	*	*	*		
A-H		GENERATOR FREQUENCY 542-7700-004 (13499)	EA	1								3-5	1A4A1Z1	
P-F		INSULATION SLEEVING, ELECTRICAL TEPTW22B (81851)	FT	REF	*	*	*	*	*	*	*	*		
P-H	5961-882-5988	TRANSISTOR 2N117 (07688)	EA	7				*	*	*	*	*	3-5	1A4A1Q1
P-H	5961-882-5988	TRANSISTOR 2N117 (07688)	EA	REF				*	*	*	*	*	3-5	1A4A1Q2
P-H	5961-882-5988	TRANSISTOR 2N117 (07688)	EA	REF				*	*	*	*	*	3-5	1A4A1Q3
P-H	5961-882-5988	TRANSISTOR 2N117 (07688)	EA	REF				*	*	*	*	*	3-5	1A4A1Q4
P-H	5961-882-5988	TRANSISTOR 2N117 (07688)	EA	REF				*	*	*	*	*	3-5	1A4A1Q5

SECTION III REPAIR PARTS FOR DIRECT SUPPORT, GENERAL SUPPORT, AND DEPOT MAINTENANCE (CONTINUED)

(1) SHE CODE	(2) FEDERAL STOCK NUMBER	(3) DESCRIPTION  REFERENCE NUMBER & MFR. CODE	(4) UNIT OF MEAS	(5) QTY INC IN UNIT	(6) 30-DAY DS MAINT ALLOWANCE			(7) 30-DAY GS MAINT ALLOWANCE			(8) 1 YR ALW PER EQUIP CWTQTY	(9) DEPOT MAINT ALW PER 100 EQUIP	(10) ILLUSTRATIONS	
					(a) 1-20	(b) 21-50	(c) 51-100	(a) 1-20	(b) 21-50	(c) 51-100			(a) FIG NO.	(b) ITEM NO. OR REFERENCE DESIGNATION
P-H	5961-284-6516	SEMICONDUCTOR DEVICE, DIODE 1M198 (07688)	EA	1				*	*	*	*	*	3-5	1A4A1CR1
P-H	5961-866-0476	SEMICONDUCTOR DEVICE, DIODE 1M457 (07688)	EA	6				*	*	*	*	*	3-5	1A4A1CR3
P-H	5961-866-0476	SEMICONDUCTOR DEVICE, DIODE 1M457 (07688)	EA	REF				*	*	*	*	*	3-5	1A4A1CR4
P-H	5961-866-0476	SEMICONDUCTOR DEVICE, DIODE 1M457 (07688)	EA	REF				*	*	*	*	*	3-5	1A4A1CR5
P-H	5961-866-0476	SEMICONDUCTOR DEVICE, DIODE 1M458 (07688)	EA	REF				*	*	*	*	*	3-5	1A4A1CR6
M-H		WIRE, ELECTRICAL 00702-1322 (70567)	FT	REF										
P-H	5999-790-0641	PRINTED CIRCUIT BOARD 542-7699-004 (13499)	EA	1				*	*	*	*	*	3-5	1A4A1TB1
XI-H		EYELET, METALLIC SE24CAEPL (90030)	EA	9										
XI-H		EYELET, METALLIC 542-0810-003 (13499)	EA	996										
P-H		TERMINAL, STUD 542-4085-002 (13499)	EA	200				*	*	*	*	*		
XI-H		PRINTED CIRCUIT BOARD 542-7701-004 (13499)	EA	1										
XI-H		BRACKET, ANGLE 542-7688-002 (13499)	EA	1										
P-H	5935-613-3914	JACK TIP SA72BC (98291)	EA	3				*	*	*	*	*	3-5	1A4A1J1
P-H	5935-615-3914	JACK TIP SKT2BC (98291)	EA	REF				*	*	*	*	*	3-5	1A4A1J2
P-H	5935-615-3914	JACK TIP SKT2BC (98291)	EA	REF				*	*	*	*	*	3-5	1A4A1J3
XI-H		BRACKET, ANGLE 542-7689-002 (13499)	EA	1										
P-H	5905-060-2484	RESISTOR, FIXED, FILM RM65D2612F (81349)	EA	3				*	*	*	*	*	3-5	1A4AIR4
P-H	5905-060-2484	RESISTOR, FIXED, FILM RM65D2612F (81349)	EA	REF				*	*	*	*	*	3-5	1A4AIR9
P-H	5905-679-9351	RESISTOR, FIXED, FILM MF1-4 50PFM23-7K (19701)	EA	2				*	*	*	*	*	3-5	1A4AIR8
P-H	5905-951-4045	RESISTOR, FIXED, FILM RM65D4641F (81349)	EA	6				*	*	*	*	*	3-5	1A4AIR3
P-H	5905-951-4045	RESISTOR, FIXED, FILM RM65D4641F (81349)	EA	REF				*	*	*	*	*	3-5	1A4AIR6
P-H	5905-951-4045	RESISTOR, FIXED, FILM RM65D4641F (81349)	EA	REF				*	*	*	*	*	3-5	1A4AIR7
P-H	5905-951-4045	RESISTOR, FIXED, FILM RM65D4641F (81349)	EA	REF				*	*	*	*	*	3-5	1A4AIR10
P-H	5905-279-2019	RESISTOR, FIXED, COMPOSITION RC20GF512J (81349)	EA	1				*	*	*	*	*	3-5	1A4AIR2
P-H	5905-195-6758	RESISTOR, FIXED, COMPOSITION RC20GF273K (81349)	EA	1				*	*	*	*	*	3-5	1A4AIR11
P-H	5905-295-3403	RESISTOR, FIXED, COMPOSITION RC20GF225K (81349)	EA	1				*	*	*	*	*	3-5	1A4AIR1
P-H	5910-927-2735	CAPACITOR, FIXED, MICA DIELECTRIC GM20E202G-500NV (72136)	EA	1				*	*	*	*	*	3-5	1A4A1C3

SECTION III REPAIR PARTS FOR DIRECT SUPPORT, GENERAL SUPPORT, AND DEPOT MAINTENANCE (CONTINUED)

(1) SRR CODE	(2) FEDERAL STOCK NUMBER	(3) DESCRIPTION  REFERENCE NUMBER & MFR. CODE	(4) UNIT OF MEAS	(5) QTY INC IN UNIT	(6) 30-DAY DS MAINT ALLOWANCE			(7) 30-DAY GS MAINT ALLOWANCE			(8) 1 YR ALW PER EQUIP CNTGTY	(9) DEPOT MAINT ALW PER 100 EQUIP	(10) ILLUSTRATIONS	
					(a) 1-20	(b) 21-50	(c) 51-100	(a) 1-20	(b) 21-50	(c) 51-100			(a) FIG NO.	(b) ITEM NO. OR REFERENCE DESIGNATION
P-H	5910-899-8127	CAPACITOR, FIXED, MICA DIELECTRIC CM35E752G0 (72136)	EA	1				*	*	*	*	*	3-5	1A4A1C5
P-H	5910-044-4961	CAPACITOR, FIXED, MICA DIELECTRIC CM35F133003-100V (72136)	EA	1				*	*	*	*	*	3-5	1A4A1C4
P-H	5910-655-0390	CAPACITOR, FIXED, PAPER DIELECTRIC SDB1K01153M (53021)	EA	1				*	*	*	*	*	3-5	1A4A1C7
P-H	5910-825-3252	CAPACITOR, FIXED, PAPER DIELECTRIC SDB1K06222M (53021)	EA	2				*	*	*	*	*	3-5	1A4A1C1
P-H	5910-825-3252	CAPACITOR, FIXED, PAPER DIELECTRIC SDB1K06222M (53021)	EA	REF				*	*	*	*	*	3-5	1A4A1C6
P-H	5910-668-4728	CAPACITOR, FIXED, MICA DIELECTRIC CM20E242G (72136)	EA	1				*	*	*	*	*	3-5	1A4A1C2
P-H	5950-617-8694	TRANSFORMER, PULLEY O2-310 (80483)	EA	1				*	*	*	*	*	3-5	1A4A1T1
P-H	5950-617-8695	TRANSFORMER, PULLEY O2-312 (80483)	EA	1				*	*	*	*	*	3-5	1A4A1T2
P-H	5905-044-5507	RESISTOR, FIXED, FILM MF1-450PFM19-6K (19701)	EA	1				*	*	*	*	*	3-5	1A4A1R5
P-H	5905-141-1130	RESISTOR, FIXED, COMPOSITION RC20GF272J (81349)	EA	1				*	*	*	*	*	3-5	1A4A1R18
A-H		GENERATOR FREQUENCY 542-7706-004 (13499)	EA	1									3-5	1A4A1Z2
P-H	5950-617-8693	TRANSFORMER, PULLEY O2-311 (80483)	EA	1				*	*	*	*	*	3-5	1A4A1T3
M-H		INSULATION SLEEVING, ELECTRICAL TEPIW22B (81851)	FT	REF										
P-H	5910-813-0406	CAPACITOR, FIXED, ELECTROLYTIC CL23CH100T13 (81349)	EA	1				*	*	*	*	*	3-5	1A4A1C16
P-H	5950-594-1217	COIL, RADIO FREQUENCY 18-124 (09250)	EA	1				*	*	*	*	*	3-5	1A4A1L1
P-H	5961-882-5988	TRANSISTOR 2N117 (07688)	EA	REF				*	*	*	*	*	3-5	1A4A1Q6
P-H	5961-882-5988	TRANSISTOR 2N117 (07688)	EA	REF				*	*	*	*	*	3-5	1A4A1Q7
P-H	5961-866-0476	SEMICONDUCTOR DEVICE, DIODE 1N457 (07688)	EA	REF				*	*	*	*	*	3-5	1A4A1CR7
P-H	5961-866-0476	SEMICONDUCTOR DEVICE, DIODE 1N457 (07688)	EA	REF				*	*	*	*	*	3-5	1A4A1CR8
P-H	5999-790-0598	PRINTED CIRCUIT BOARD 542-7705-004 (13499)	EA	1				*	*	*	*	*	3-5	1A4A1TB2
XI-H		PRINTED CIRCUIT BOARD 542-7704-004 (13499)	EA	1										
P-H		TERMINAL, STUD 542-4085-002 (13499)	EA	REF				*	*	*	*	*		
XI-H		EYELET, METALLIC 542-0810-003 (13499)	EA	REF										
P-H	5905-060-2484	RESISTOR, FIXED, FILM RN65D2612F (81349)	EA	REF				*	*	*	*	*	3-5	1A4A1R13
P-H	5905-951-4045	RESISTOR, FIXED, FILM RN65D4641F (81349)	F1	REF				*	*	*	*	*	3-5	1A4A1R12
P-H	5905-951-4045	RESISTOR, FIXED, FILM RN65D4641F (81349)	EA	REF				*	*	*	*	*	3-5	1A4A1R15
P-H	5905-679-9351	RESISTOR, FIXED, FILM MF1-4 50PFM23-7K (19701)	EA	REF				*	*	*	*	*	3-5	1A4A1R14



SECTION III REPAIR PARTS FOR DIRECT SUPPORT, GENERAL SUPPORT, AND DEPOT MAINTENANCE (CONTINUED)

(1) SR CODE	(2) FEDERAL STOCK NUMBER	(3) DESCRIPTION  REFERENCE NUMBER & MFR. CODE	(4) UNIT OF MEAS	(5) QTY INC IN UNIT	(6) 30-DAY GS MAINT ALLOWANCE			(7) 30-DAY GS MAINT ALLOWANCE			(8) 1 YR ALM PER EQUIP CNTCY	(9) DEPOT MAINT ALM PER 100 EQUIP	(10) ILLUSTRATIONS	
					(a) 1-20	(b) 21-50	(c) 51-100	(a) 1-20	(b) 21-50	(c) 51-100			(a) FIG NO.	(b) ITEM NO. OR REFERENCE DESIGNATION
P-H	5905-190-8879	RESISTOR, FIXED, COMPOSITION RC20GF183K (81349)	EA	1				*	*	*	*	*	3-5	1A4A1R16
P-H	5905-279-2628	RESISTOR, FIXED, COMPOSITION RC32GF271K (81349)	EA	1				*	*	*	*	*	3-5	1A4A1R17
P-H	5910-577-6971	CAPACITOR, FIXED, MICA DIELECTRIC CM35F203G03-100V (72136)	EA	4				*	*	*	*	*	3-5	1A4A1C8
P-H	5910-577-6971	CAPACITOR, FIXED, MICA DIELECTRIC CM35F203G03-100V (72136)	EA	REF				*	*	*	*	*	3-5	1A4A1C9
P-H	5910-577-6971	CAPACITOR, FIXED, MICA DIELECTRIC CM35F203G03-100V (72136)	EA	REF				*	*	*	*	*	3-5	1A4A1C10
P-H	5910-577-6971	CAPACITOR, FIXED, MICA DIELECTRIC CM35F203G03-100V (72136)	EA	REF				*	*	*	*	*	3-5	1A4A1C11
P-H	5910-835-2175	CAPACITOR, FIXED, MICA DIELECTRIC SDB1K01102M (53021)	EA	1				*	*	*	*	*	3-5	1A4A1C12
P-H	5910-553-5036	CAPACITOR, FIXED, PAPER DIELECTRIC SDB1K01104M (53021)	EA	3				*	*	*	*	*	3-5	1A4A1C13
P-H	5910-553-5036	CAPACITOR, FIXED, PAPER DIELECTRIC SDB1K01104M (53021)	EA	REF				*	*	*	*	*	3-5	1A4A1C14
P-H	5910-553-5036	CAPACITOR, FIXED, PAPER DIELECTRIC SDB1K01104M (53021)	EA	REF				*	*	*	*	*	3-5	1A4A1C15
M-H		INSULATION SLEEVING, ELECTRICAL TEPTW20R (81851)	FT	25										
P-R		SCREW, SHOULDERED 542-7683-002 (13499)	EA	22				*	*	*	*	*		
X2-H		PLATE, COVER 549-4447-003 (13499)	EA	1										
X2-H		PLATE, COVER 542-7695-003 (13499)	EA	1										
A-O-R		STABILIZED OSCILLATOR 528-0176-005 (13499)	EA	1									3-4	1A4A3
P-O	5960-045-8639	ELECTRON TUBE 5654 (89185)	EA	2	*	*	*	*	*	*	*	*	3-6	1A4A3V1
P-O	5960-045-8639	ELECTRON TUBE 5654 (89185)	EA	REF	*	*	*	*	*	*	*	*	3-6	1A4A3V3
P-O	5960-262-3002	ELECTRON TUBE 5750 (89185)	EA	1	*	*	*	*	*	*	*	*	3-6	1A4A3V2
P-O	5960-188-6584	ELECTRON TUBE 5670 (89185)	EA	1	*	*	*	*	*	*	*	*	3-6	1A4A3V4
P-F		TERMINAL, LUG 4007-4HOTTINNED (77147)	EA	REF	*	*	*	*	*	*	*	*		
P-F	1430-956-4907	BEARING, BALL, ANNULAR SS77R3XR1E (43334)	EA	2	*	*	*	*	*	*	*	*	3-6	1A4A3P27
P-F	1430-956-4907	BEARING, BALL, ANNULAR SS77R3XR1E (43334)	EA	REF	*	*	*	*	*	*	*	*	3-6	1A4A3P28
P-F	5910-042-9609	WASHER, LOCK MS35338-78 (96906)	EA	REF	*	*	*	*	*	*	*	*		
P-F	5310-011-1041	WASHER, LOCK MS35338-79 (96906)	EA	REF	*	*	*	*	*	*	*	*		
P-F		NUT, PLAIN, HEXAGON P313-0132-000 (77250)	EA	113	*	*	*	*	*	*	*	*		
P-F		NUT, PLAIN, SQUARE P334-0485-000 (77250)	EA	REF	*	*	*	*	*	*	*	*		
P-F		NUT, PLAIN P334-0486-000 (77250)	EA	REF	*	*	*	*	*	*	*	*		

SECTION III REPAIR PARTS FOR DIRECT SUPPORT, GENERAL SUPPORT, AND DEPOT MAINTENANCE (CONTINUED)

(1) SIR CODE	(2) FEDERAL STOCK NUMBER	(3) DESCRIPTION  USABLE ON CODE	(4) UNIT OF MEAS	(5) QTY INC IN UNIT	(6) 30-DAY DS MAINT ALLOWANCE			(7) 30-DAY GS MAINT ALLOWANCE			(8) 1 YR ALW PER EQUIP CNTGCT	(9) DEPOT MAINT ALW PER 100 EQUIP	(10) ILLUSTRATIONS	
					(a) 1-20	(b) 21-50	(c) 51-100	(a) 1-20	(b) 21-50	(c) 51-100			(a) FIG NO.	(b) ITEM NO. OR REFERENCE DESIGNATION
P-F		SCREW, CAPTIVE SOCKET HEAD B2A440-5C3 (08664)	EA	14	*	*	*	*	*	*	*			
P-F		SCREW, CAPTIVE 324-1682-060 (13499)	EA	4	*	*	*	*	*	*	*			
P-F		SCREW, CAPTIVE, SOCKET HEAD B2A440-8C3 (08664)	EA	6	*	*	*	*	*	*	*			
P-F		SCREW, CAPTIVE 324-1682-100 (13499)	EA	REF	*	*	*	*	*	*	*			
P-F		SCREW, CAPTIVE SOCKET HEAD 324-0018-000 (08664)	EA	2	*	*	*	*	*	*	*			
P-F	5340-720-8064	RING, RETAINING MS16624-1G25 (96906)	EA	9	*	*	*	*	*	*	*			
P-F	5340-205-4731	RING, RETAINING MS16633-1009 (96906)	EA	REF	*	*	*	*	*	*	*			
P-F	5305-777-6039	SCREW, MACHINE MS51959-12 (96906)	EA	REF	*	*	*	*	*	*	*			
P-F	5305-764-2966	SCREW, MACHINE MS51959-2 (96906)	EA	17	*	*	*	*	*	*	*			
P-F	5305-770-2533	SCREW, MACHINE MS51959-13 (96906)	EA	130	*	*	*	*	*	*	*			
P-F		SCREW, MACHINE P342-0054-000 (77250)	EA	1	*	*	*	*	*	*	*			
P-F		SCREW, MACHINE P347-0021-000 (77250)	EA	4	*	*	*	*	*	*	*			
P-F	5305-764-2964	SCREW, MACHINE MS51959-4 (96906)	EA	2	*	*	*	*	*	*	*			
P-F	5305-766-2422	SCREW, MACHINE MS51959-1 (96906)	EA	2	*	*	*	*	*	*	*			
P-F		SCREW, MACHINE P342-0055-0G3 (77250)	EA	4	*	*	*	*	*	*	*			
P-F	5305-763-6955	SCREW, MACHINE MS51959-21 (96906)	EA	2	*	*	*	*	*	*	*			
P-F	5305-054-5646	SCREW, MACHINE MS51957-12 (96906)	EA	66	*	*	*	*	*	*	*			
P-F		SCREW, MACHINE MS51957-16 (96906)	EA	REF	*	*	*	*	*	*	*			
P-F	5305-054-6659	SCREW, MACHINE MS51957-35 (96906)	EA	4	*	*	*	*	*	*	*			
P-F	5305-054-6657	SCREW, MACHINE MS51957-33 (96906)	EA	2	*	*	*	*	*	*	*			
P-F		SCREW, MACHINE P330-229C-000 (77250)	EA	25	*	*	*	*	*	*	*			
P-F		SCREW, MACHINE P347-0007-000 (77250)	EA	8	*	*	*	*	*	*	*			
P-F	5305-054-5647	SCREW, MACHINE MS51957-13 (96906)	EA	REF	*	*	*	*	*	*	*			
P-F	5310-058-3599	SCREW, MACHINE MS3535-57 (96906)	EA	REF	*	*	*	*	*	*	*			
P-F	5960-858-5172	SHIELD ASSEMBLY 541-6550-003 (13499)	EA	2	*	*	*	*	*	*	*	3-6	14A3E15	
P-F	5960-858-5172	SHIELD ASSEMBLY 541-6550-003 (13499)	EA	REF	*	*	*	*	*	*	*	3-6	14A3E18	

SECTION III REPAIR PARTS FOR DIRECT SUPPORT, GENERAL SUPPORT, AND DEPOT MAINTENANCE (CONTINUED)

(1) SIB CODE	(2) FEDERAL STOCK NUMBER	(3) DESCRIPTION  REFERENCE NUMBER & MFR. CODE	(4) UNIT OF MEAS	(5) QTY REQ IN UNIT	(6) 30-DAY DS MAINT ALLOWANCE			(7) 30-DAY GS MAINT ALLOWANCE			(8) 1 YR ALW PER EQUIP CMTY	(9) DEPOT MAINT ALW PER 100 EQUIP	(10) ILLUSTRATIONS	
					(a)	(b)	(c)	(a)	(b)	(c)			(a) FIG NO.	(b) ITEM NO. OR REFERENCE DESIGNATION
					1-20	21-50	51-100	1-20	21-50	51-100				
XI-F		SHIELD, ELECTRON 121-0F1001 (91662) -OR-	EA	2										
XI-F		SHIELD, ELECTRON 541-8170-002 (13499)	EA	2										
XI-F		SHIELD, ELECTRON 541-8157-002 (13499)	EA	2										
XI-F		SHIELD 541-8157-012 (13499)	EA	2										
P-F	55340-769-2240	SPRING, HELICAL 541-8163-002 (13499)	EA	12	*	*	*	*	*	*	*	*		
XI-F		RETAINER, TUBE 541-6517-002 (13499)	EA	2										
P-F	55960-564-4772	SHIELD ASSEMBLY 541-6551-003 (13499)	EA	1	*	*	*	*	*	*	*	*	3-6	1A4A3E17
P-F	55960-581-8696	SHIELD, ELECTRON 120-0F3001 (91662) -OR-	EA	1	*	*	*	*	*	*	*	*		
P-F	55960-614-8676	SHIELD, ELECTRON 541-8169-002 (13499)	EA	1	*	*	*	*	*	*	*	*		
XI-F		SHIELD, ELECTRON 541-8158-002 (13499)	EA	1										
XI-F		SHIELD 541-8158-012 (13499)	EA	1										
P-F	55340-769-2240	SPRING, HELICAL 541-8163-002 (13499)	EA	REF	*	*	*	*	*	*	*	*		
XI-F		RETAINER, TUBE 541-6518-003 (13499)	EA	1										
P-F	55960-686-7353	SHIELD ASSEMBLY 541-6553-003 (13499)	EA	1	*	*	*	*	*	*	*	*	3-6	1A4A3E16
XI-F		SHIELD, ELECTRON 193-0F1001 (91662) -OR-	EA	1										
XI-F		SHIELD, ELECTRON 541-8167-002 (13499)	EA	1										
XI-F		SHIELD, ELECTRON 541-8160-002 (13499)	EA	1										
XI-F		SHIELD 541-8160-012 (13499)	EA	1										
P-F	55340-769-2243	SPRING, HELICAL 541-8164-002 (13499)	EA	9	*	*	*	*	*	*	*	*		
XI-F		RETAINER, TUBE 541-6520-002 (13499)	EA	1										
P-F		WASHER, FLAT 902-1515-002 (13499)	EA	5	*	*	*	*	*	*	*	*		
P-F	55820-396-3116	CLAMP 504-7537-002 (13499)	EA	2	*	*	*	*	*	*	*	*		
P-F		WASHER 506-5910-003 (13499)	EA	2	*	*	*	*	*	*	*	*		
P-F	55310-183-4354	WASHER, FLAT 506-7367-002 (13499)	EA	REF	*	*	*	*	*	*	*	*		
M-H		INSULATION SLEEVING, ELECTRICAL M1113190C1BA15ZE13-0 (81349)	FT	1										
P-F	55340-090-4035	CLIP, RETAINING 502-6005-002 (13499)	EA	35	*	*	*	*	*	*	*	*		
A-F		PLATE ASSEMBLY-GEAR 543-1802-005 (13499)	EA	1										

SECTION III REPAIR PARTS FOR DIRECT SUPPORT, GENERAL SUPPORT, AND DEPOT MAINTENANCE (CONTINUED)

(1) SR CODE	(2) FEDERAL STOCK NUMBER	(3) DESCRIPTION  REFERENCE NUMBER & MFR. CODE	(4) UNIT OF MEAS	(5) QTY INC IN UNIT	(6)						(8) 1 YR ALM PER EQUIP CRNGCY	(9) DEPOT MAINT ALM PER 100 EQUIP	(10)	
					30-DAY DS MAINT ALLOWANCE			30-DAY GS MAINT ALLOWANCE					(a) FIG NO.	(b) ITEM NO. OR REFERENCE DESIGNATION
					(a) 1-20	(b) 21-50	(c) 51-100	(a) 1-20	(b) 21-50	(c) 51-100				
P-F	5340-720-8064	RING, RETAINING MS16624-1025 (96906)	EA	REF	*	*	*	*	*	*	*			
P-F	5340-282-1633	RING, RETAINING MS16633-1018 (96906)	EA	3	*	*	*	*	*	*	*			
P-F	5305-763-6962	SCREW, MACHINE MS51959-27 (96906)	EA	10	*	*	*	*	*	*	*			
P-F	5305-765-4244	SCREW, MACHINE MS51959-41 (96906)	EA	4	*	*	*	*	*	*	*			
A-F		PLATE, GEAR ASSEMBLY 543-1795-004 (13499)	EA	1										
P-F	5310-809-8135	NUT, PLAIN, CLINCH F632-2 (46384)	EA	2	*	*	*	*	*	*	*			
P-F		BEARING, BALL, ANNULAR S418FCRHP37L02 (40920)	EA	3	*	*	*	*	*	*	*	3-6	1A4A3MP16	
P-F		BEARING, BALL, ANNULAR S418FCRHP37L02 (40920)	EA	REF	*	*	*	*	*	*	*	3-6	1A4A3MP17	
P-F		BEARING, BALL, ANNULAR S418FCRHP37L02 (40920)	EA	REF	*	*	*	*	*	*	*	3-6	1A4A3MP18	
P-F	3110-447-4775	BEARING, BALL, ANNULAR S5632FCRHP37L02 (40920)	EA	2	*	*	*	*	*	*	*	3-6	1A4A3MP8	
P-F	3110-447-4775	BEARING, BALL, ANNULAR S5632FCRHP37L02 (40920)	EA	REF	*	*	*	*	*	*	*	3-6	1A4A3MP19	
X1-F		HUB 543-1633-002 (13499)	EA	2								3-6	1A4A3MP29	
X1-F		HUB 543-1633-002 (13499)	EA	REF								3-6	1A4A3MP30	
X2-F		PLATE, GEAR 543-1794-004 (13499)	EA	1										
X2-F		PLATE, GEAR 543-1792-004 (13499)	EA	1										
X2-F		PLATE, GEAR-REAR 543-1793-004 (13499)	EA	1										
P-F		POST, BEARING 543-1652-002 (13499)	EA	1	*	*	*	*	*	*	*			
P-F		POST, BEARING 543-1654-002 (13499)	EA	1	*	*	*	*	*	*	*			
P-F		WASHER, FLAT 310-6360-000 (79807)	EA	REF	*	*	*	*	*	*	*			
P-F	5340-720-8064	RING, RETAINING MS16624-1025 (96906)	EA	REF	*	*	*	*	*	*	*			
P-F	5305-054-6650	SCREW, MACHINE MS51957-26 (96906)	EA	REF	*	*	*	*	*	*	*			
P-F		PIN, BUMPER 543-1804-002 (13499)	EA	1	*	*	*	*	*	*	*			
P-F		PIN, PIVOT 543-1805-002 (13499)	EA	1	*	*	*	*	*	*	*			
P-H	3020-676-2832	GEAR CLUSTER 543-1650-002 (13499)	EA	1				*	*	*	*	3-6	1A4A3MP1	
P-F		GEAR, BLANK 543-1649-002 (13499)	EA	1	*	*	*	*	*	*	*			
X1-H		GEAR, SPUR 543-1647-002 (13499)	EA	1										
P-F		GEAR, SPUR-CAM 543-1651-002 (13499)	EA	1	*	*	*	*	*	*	*	3-6	1A4A3MP2	

SECTION III REPAIR PARTS FOR DIRECT SUPPORT, GENERAL SUPPORT, AND DEPOT MAINTENANCE (CONTINUED)

(1) SR CODE	(2) FEDERAL STOCK NUMBER	(3) DESCRIPTION  USABLE ON CODE	(4) UNIT OF MEAS	(5) QTY INC IN UNIT	(6) 30-DAY DS MAINT ALLOWANCE			(7) 30-DAY GS MAINT ALLOWANCE			(8) 1 YR ALM PER EQUIP CNTGTY	(9) DEPOT MAINT PER 100 EQUIP	(10) ILLUSTRATIONS	
					(a)	(b)	(c)	(a)	(b)	(c)			(a)	(b)
					1-20	21-50	51-100	1-20	21-50	51-100			FIG NO.	ITEM NO. OR REFERENCE DESIGNATION
P-F		POST, DOWEL 543-1657-002 (13499)	EA	2	*	*	*	*	*	*	*			
P-F		POST, SPACING 543-1658-002 (13499)	EA	3	*	*	*	*	*	*	*			
P-F		SETScrew 335-0022-000 (08664)	EA	2	*	*	*	*	*	*	*			
P-H	3020-676-2836	GEAR, CLUSTER 543-1646-002 (13499)	EA	1				*	*	*	*	3-6	1A4A3MP5	
XI-H		GEAR, BLANK 543-1645-002 (13499)	EA	1										
XI-H		GEAR, SPUR 543-1644-002 (13499)	EA	1								3-6	1A4A3MP35	
P-H	5821-676-2837	GUIDE, REAR 543-1737-002 (13499)	EA	1				*	*	*	*	3-6	1A4A3MP22	
P-F	5310-058-3829	WASHER, LOCK MS35338-77 (96906)	EA	71	*	*	*	*	*	*	*			
P-F		SCREW, MACHINE P347-0921-000 (77250)	EA	REF	*	*	*	*	*	*	*			
XI-F		PLATE, GUIDE 543-1730-002 (13499)	EA	1										
P-F		SPRING, HELICAL 543-1736-002 (13499)	EA	1	*	*	*	*	*	*	*	3-6	1A4A3MP36	
XI-P		GUIDE, HOUSING 543-1738-002 (13499)	EA	1										
P-F		PIN, GUIDE 543-1739-002 (13499)	EA	1	*	*	*	*	*	*	*			
P-F	5340-205-4731	RING, RETAINING MS16633-1009 (96906)	EA	REF	*	*	*	*	*	*	*			
P-F	5340-810-4239	RING, RETAINING MS16633-1012 (96906)	EA	1	*	*	*	*	*	*	*			
P-F	5340-329-0006	SPRING, HELICAL 340-2090-000 (91314)	EA	1	*	*	*	*	*	*	*			
P-F		WASHER, FLAT 502-1515-002 (13499)	EA	REF	*	*	*	*	*	*	*			
P-F		WASHER 504-0750-000 (13499)	EA	1	*	*	*	*	*	*	*			
P-H	5821-676-2834	CAM 543-1806-002 (13499)	EA	1				*	*	*	*	3-6	1A4A3MP12	
P-H	3040-684-3149	COLLAR, SHAFT 543-1807-002 (13499)	EA	1				*	*	*	*			
P-H	3020-676-2835	GEAR, IDLER-PRESSED 543-1811-002 (13499)	EA	1				*	*	*	*			
XI-H		GEAR, CLUSTER 543-1648-002 (13499)	EA	1								3-6	1A4A3MP32	
XI-H		GEAR, BLANK 543-1643-002 (13499)	EA	1										
XI-H		GEAR, SPUR-IDLER 543-1653-002 (13499)	EA	1								3-6	1A4A3MP33	
P-H	3020-832-6622	ARM, STOPPING 543-1812-002 (13499)	EA	1				*	*	*	*			
P-H		FOLLOWER, CAM 543-1813-002 (13499)	EA	1				*	*	*	*			
X2-H		FOLLOWER, CAM 543-1808-002 (13499)	EA	1										

SECTION III REPAIR PARTS FOR DIRECT SUPPORT, GENERAL SUPPORT, AND DEPOT MAINTENANCE (CONTINUED)

(1) SR CODE	(2) FEDERAL STOCK NUMBER	(3) DESCRIPTION  REFERENCE NUMBER & MFR. CODE	(4) UNIT OF MEAS  USABLE ON CODE	(5) QTY REQD IN UNIT	(6) 30-DAY DS MAINT ALLOWANCE			(7) 30-DAY GS MAINT ALLOWANCE			(8) 1 YR ALW PER EQUIP CATEG	(9) DEPOT MAINT ALW PER 100 EQUIP	(10) ILLUSTRATIONS	
					(a)	(b)	(c)	(a)	(b)	(c)			(a) FIG NO.	(b) ITEM NO. OR REFERENCE DESIGNATION
					1-20	21-50	51-100	1-20	21-50	51-100				
P-H		PIN, GROOVED 543-1809-002 (13499)	EA	1				*	*	*	*	*		
P-H		SCREW, SHOULDERED 542-7683-002 (13499)	EA	REF				*	*	*	*	*		
P-H		SPRING, HELICAL 542-5381-002 (13499)	EA	2				*	*	*	*	*	3-6	1A4A3MP9
P-H		SPRING, HELICAL 542-5381-002 (13499)	EA	REF				*	*	*	*	*	3-6	1A4A3MP25
P-H		POST, ROLLER 543-1636-002 (13499)	EA	2				*	*	*	*	*		
X2-H		RACK, SLUG-PRESSED 543-1634-002 (13499)	EA	1										
X2-H		RACK, SLUG 543-6045-003 (13499)	EA	1										
X2-H		BACK-CASTING 543-6045-013 (13499)	EA	1										
P-H		POST, GUIDE 543-1716-002 (13499)	EA	4				*	*	*	*	*		
X2-H		PLATE, LEFT SIDE 543-1754-003 (13499)	EA	1										
X2-H		BLOCK, RETAINING-REAR 543-1638-002 (13499)	EA	1										
X2-H		BLOCK, MOUNTING-REAR 543-1639-002 (13499)	EA	2										
P-H	3020-676-2838	GEAR, SPUR 543-1655-002 (13499)	EA	1				*	*	*	*	*	3-6	1A4A3MP6
P-F	5821-676-2804	BAND, ROLLED 543-1640-002 (13499)	EA	2	*	*	*	*	*	*	*	*		
X1-F		EYELET, METALLIC 2036SILFL (G1881)	EA	4										
X1-F		BAND 543-1637-002 (13499)	EA	2										
P-F		WASHER, FLAT 310-0139-000 (05411)	EA	8	*	*	*	*	*	*	*	*		
X2-F		BLOCK, MOUNTING-LEFT 543-1659-002 (13499)	EA	1										
X2-F		BLOCK, MOUNTING-RIGHT 543-1660-002 (13499)	EA	1										
P-F		POST, RECEPTACLE 543-1661-002 (13499)	EA	2	*	*	*	*	*	*	*	*		
X2-F		PARTITION, FRONT 543-1662-002 (13499)	EA	1										
P-F	5310-918-7213	NUT, CAPTIVE NCM-2-2-1 (07886)	EA	40	*	*	*	*	*	*	*	*		
X2-F		PARTITION, FRONT 543-1755-003 (13499)	EA	1										
X2-F		PARTITION, MIDDLE 543-1663-002 (13499)	EA	1										
P-F	5310-918-7213	NUT, CAPTIVE NCM-2-2-1 (07886)	EA	REF	*	*	*	*	*	*	*	*		
X2-F		PARTITION, MIDDLE 543-1756-003 (13499)	EA	1										
P-H	5340-526-3899	CLIP, SPRING TENSION 100-200-4-0 (99378)	EA	3				*	*	*	*	*		

SECTION III REPAIR PARTS FOR DIRECT SUPPORT, GENERAL SUPPORT, AND DEPOT MAINTENANCE (CONTINUED)

(1) SIR CODE	(2) FEDERAL STOCK NUMBER	(3) DESCRIPTION  USABLE ON CODE	(4) UNIT OF MEAS	(5) QTY INC IN UNIT	(6) 30-DAY DS MAINT ALLOWANCE			(7) 30-DAY GS MAINT ALLOWANCE			(8) 1 YR ALM PER EQUIP CMTGTY	(9) DEPOT MAINT ALM PER 100 EQUIP	(10) ILLUSTRATIONS	
					(a)	(b)	(c)	(a)	(b)	(c)			(a)	(b)
					1-20	21-50	51-100	1-20	21-50	51-100			FIG NO.	ITEM NO. OR REFERENCE DESIGNATION
X1-H		RIVET, TUBULAR R3484X1-8CADPL (12014)	EA	33										
X2-H		PLATE, RIGHT 543-1760-003 (13499)	EA	1										
X2-H		PLATE, REAR 543-6047-003 (13499)	EA	1										
X2-H		COVER, FRONT 548-8055-002 (13499)	EA	1										
P-H	5310-141-1813	NUT, PLAIN, CLINCH CL4401C (46384)	EA	REF				*	*	*	*			
P-H	5310-141-1813	NUT, PLAIN CL4401C (46384)	EA	REF				*	*	*	*			
X2-H		COVER, FRONT 548-8057-003 (13499)	EA	1										
P-F		POST, COVER FRONT 543-1664-002 (13499)	EA	1	*	*	*	*	*	*	*			
P-F		POST, FASTENING 543-1665-002 (13499)	EA	1	*	*	*	*	*	*	*			
A-F		OSCILLATOR 545-5839-005 (13499)	EA	1										
P-F	5935-729-7312	SOCKET, ELECTRON 7490-0189 (80368)	EA	1	*	*	*	*	*	*	*		3-6	1A4A3XV4
P-F	5935-232-3758	SOCKET, ELECTRON 7470-0229 (94991)	EA	3	*	*	*	*	*	*	*		3-6	1A4A3XV1
P-F	5935-232-3758	SOCKET, ELECTRON 7470-0229 (94991)	EA	REF	*	*	*	*	*	*	*		3-6	1A4A3XV2
P-F	5935-232-3758	SOCKET, ELECTRON 7470-0229 (94991)	EA	REF	*	*	*	*	*	*	*		3-6	1A4A3XV3
M-H		INSULATION SLEEVING, ELECTRICAL TEFTW20B (81851)	FT	REF										
P-F	5910-803-2882	CAPACITOR, FIXED, PAPER, DIELECTRIC C224SKB24 (81349)	EA	1	*	*	*	*	*	*	*		3-6	1A4A3C19
P-F	5910-552-9868	CAPACITOR, FIXED, PAPER, DIELECTRIC NPTH3PIL (14655)	EA	1	*	*	*	*	*	*	*		3-6	1A4A3C37
P-F	5310-058-2949	WASHER, LOCK MS35337-78 (96906)	EA	77	*	*	*	*	*	*	*			
P-F		TERMINAL, LUG 4007-4HOTFINNED (77147)	EA	REF	*	*	*	*	*	*	*			
P-F		NUT, PLAIN, HEXAGON P313-0132-000 (77250)	EA	REF	*	*	*	*	*	*	*			
P-F	5305-770-2533	SCREW, MACHINE MS51959-13 (96906)	EA	REF	*	*	*	*	*	*	*			
P-F	5305-054-5647	SCREW, MACHINE MS51957-13 (96906)	EA	REF	*	*	*	*	*	*	*			
P-F	5305-054-5648	SCREW, MACHINE MS51957-14 (96906)	EA	101	*	*	*	*	*	*	*			
P-F	5305-054-5651	SCREW, MACHINE MS51957-17 (96906)	EA	4	*	*	*	*	*	*	*			
P-H	5961-284-6516	SEMICONDUCTOR DEVICE, DIODE LN198 (07688)	EA	1				*	*	*	*			
P-H	5961-552-9852	SEMICONDUCTOR DEVICE, DIODE, LN251 (81349)	EA	6				*	*	*	*		3-6	1A4A3CR1
P-H	5961-552-9852	SEMICONDUCTOR DEVICE, DIODE LN251 (81349)	EA	REF				*	*	*	*		3-6	1A4A3CR2

SECTION III REPAIR PARTS FOR DIRECT SUPPORT, GENERAL SUPPORT, AND DEPOT MAINTENANCE (CONTINUED)

(1) SIC CODE	(2) FEDERAL STOCK NUMBER	(3) DESCRIPTION  USABLE ON CODE	(4) UNIT OF MEAS	(5) QTY INC IN UNIT	(6) 30-DAY DS MAINT ALLOWANCE			(7) 30-DAY GS MAINT ALLOWANCE			(8) 1 YR ALW PER EQUIP CNTGCTY	(9) DEPOT MAINT ALW PER 100 EQUIP	(10) ILLUSTRATIONS	
					(a) 1-20	(b) 21-50	(c) 51-100	(a) 1-20	(b) 21-50	(c) 51-100			(a) FIG NO.	(b) ITEM NO. OR REFERENCE DESIGNATION
P-H	5961-552-9852	SEMICONDUCTOR DEVICE, DIODE 1N251 (81349)	EA	REF				*	*	*	*	*	3-6	1A4A3CR3
P-H	5961-552-9852	SEMICONDUCTOR DEVICE, DIODE 1N251 (81349)	EA	REF				*	*	*	*	*	3-6	1A4A3CR4
P-H	5961-552-9852	SEMICONDUCTOR DEVICE, DIODE 1N251 (81349)	EA	REF				*	*	*	*	*	3-6	1A4A3CR5
P-H	5961-552-9852	SEMICONDUCTOR DEVICE, DIODE 1N251 (81349)	EA	REF				*	*	*	*	*	3-6	1A4A3CR6
M-H		WIRE, ELECTRICAL 00702-1322 (70567)	FT	REF										
M-H		WIRE, ELECTRICAL WTE734ACW91 (90484)	FT	5										
M-H		WIRE, ELECTRICAL WTE734ACW92 (90484)	FT	8										
P-F	5910-894-0917	CAPACITOR, FIXED, MICA, DIELECTRIC 22H5Q51E1 (14655)	EA	1	*	*	*	*	*	*	*	*	3-6	1A4A3C27
P-F		SPACER, SLEEVE 541-5979-002 (13499)	EA	4	*	*	*	*	*	*	*	*		
P-F	5960-088-4211	RETAINER, ELECTRICAL 541-6532-003 (13499)	EA	3	*	*	*	*	*	*	*	*	3-6	1A4A3E19
P-F	5960-088-4211	RETAINER, ELECTRICAL 541-6532-003 (13499)	EA	REF	*	*	*	*	*	*	*	*	3-6	1A4A3E20
P-F	5960-088-4211	RETAINER, ELECTRICAL 541-6532-003 (13499)	EA	REF	*	*	*	*	*	*	*	*	3-6	1A4A3E21
P-F	5933-651-2698	RETAINER, ELECTRICAL 541-6533-003 (13499)	EA	1	*	*	*	*	*	*	*	*	3-6	1A4A3E22
A-F		SHAFT, DRIVE 543-1642-002 (13499)	EA	1									3-6	1A4A3MP15
P-F		ROLLER 543-1627-002 (13499)	EA	2	*	*	*	*	*	*	*	*		
P-F		SHAFT, STRAIGHT 543-1628-002 (13499)	EA	1	*	*	*	*	*	*	*	*		
P-F	5315-291-5471	PIN, SPRING MS16562-189 (96906)	EA	4	*	*	*	*	*	*	*	*		
X2-F		CHASSIS, ELECTRICAL 543-1757-003 (13499)	EA	1										
P-F		TERMINAL, STUD 1985 (12615)	EA	23	*	*	*	*	*	*	*	*		
P-F		TERMINAL, STUD 2619A (12615)	EA	50	*	*	*	*	*	*	*	*		
X1-F		EYELET, METALLIC 307-1060-000 (13499)	EA	1										
X1-F		EYELET, METALLIC A25HOTTINNED (57771)	EA	6										
P-F	5310-918-7213	NUT, CAPTIVE NCM4-2-2-1 (07886)	EA	REF	*	*	*	*	*	*	*	*		
P-F	5935-538-3069	JACK, TIP SKT1 (98291)	EA	1	*	*	*	*	*	*	*	*	3-6	1A4A3E30
X2-F		CHASSIS, ELECTRICAL 543-1791-004 (13499)	EA	1										
P-F	5935-617-6837	JACK, TIP SKT10WHT (98291)	EA	1	*	*	*	*	*	*	*	*	3-6	1A4A3J2
X2-F		PARTITION, RADIO FREQUENCY 543-1672-002 (13499)	EA	1										



SECTION III REPAIR PARTS FOR DIRECT SUPPORT, GENERAL SUPPORT, AND DEPOT MAINTENANCE (CONTINUED)

(1) S&R CODE	(2) FEDERAL STOCK NUMBER	(3) DESCRIPTION  USABLE ON CODE	(4) UNIT OF MEAS	(5) QTY INC IN UNIT	(6) 30-DAY DS MAINT ALLOWANCE			(7) 30-DAY GS MAINT ALLOWANCE			(8) 1 YR ALW PER EQUIP CNTGCT	(9) DEPOT MAINT ALW PER 100 EQUIP	(10) ILLUSTRATIONS	
					(a)	(b)	(c)	(a)	(b)	(c)			(a) FIG NO.	(b) ITEM NO. OR REFERENCE DESIGNATION
					1-20	21-50	51-100	1-20	21-50	51-100				
P-F	5940-482-8942	TERMINAL, FREETHRU FTSM1 (98291)	EA	127	*	*	*	*	*	*	*	*		
X2-F		PARTITION 543-1669-002 (13499)	EA	1										
X2-F		PLATE, ELECTRICAL SHIELD 543-1758-003 (13499)	EA	1										
X2-F		PARTITION 543-1670-002 (13499)	EA	1										
A-F		TERMINAL BOARD 543-1724-002 (13499)	EA	1								3-6	1A4A3R2	
P-F		TERMINAL, STUD 545-3205-002 (13499)	EA	30	*	*	*	*	*	*	*	*		
M-H		TERMINAL BOARD 543-1725-002 (13499)	EA	1										
AL-F		EYELET, METALLIC 542-0810-003 (13499)	EA	REF										
P-F	5950-615-0596	TRANSFORMER, INTERMEDIATE FREQUENCY X064-1 (81815)	EA	1	*	*	*	*	*	*	*	3-6	1A4A3L3	
P-F	5905-126-6691	RESISTOR, FIXED, COMPOSITION RC20GF150J (81349)	EA	1	*	*	*	*	*	*	*	3-6	1A4A3R20	
P-F	5905-106-9344	RESISTOR, FIXED, COMPOSITION RC20GF101J (81349)	EA	1	*	*	*	*	*	*	*	3-6	1A4A3R3	
P-F	5905-171-1997	RESISTOR, FIXED, COMPOSITION RC20GF331K (81349)	EA	3	*	*	*	*	*	*	*	3-6	1A4A3R8	
P-F	5905-171-1997	RESISTOR, FIXED, COMPOSITION RC20GF331K (81349)	EA	REF	*	*	*	*	*	*	*	3-6	1A4A3R16	
P-F	5905-171-1997	RESISTOR, FIXED, COMPOSITION RC20GF331K (81349)	EA	REF	*	*	*	*	*	*	*	3-6	1A4A3R17	
P-F	5905-195-6806	RESISTOR, FIXED, COMPOSITION RC20GF102K (81349)	EA	1	*	*	*	*	*	*	*	3-6	1A4A3R11	
P-F	5905-171-2009	RESISTOR, FIXED, COMPOSITION RC20GF222K (81349)	EA	2	*	*	*	*	*	*	*	3-6	1A4A3R15	
P-F	5905-171-2009	RESISTOR, FIXED, COMPOSITION RC20GF222K (81349)	EA	REF	*	*	*	*	*	*	*	3-6	1A4A3R18	
P-F	5905-245-0023	RESISTOR, FIXED, COMPOSITION RC20GF682K (81349)	EA	1	*	*	*	*	*	*	*	3-6	1A4A3R21	
P-F	5905-299-2031	RESISTOR, FIXED, COMPOSITION RC3:GF822K (81349)	EA	1	*	*	*	*	*	*	*	3-6	1A4A3R9	
P-F	5905-141-0591	RESISTOR, FIXED, COMPOSITION RC20GF103K (81349)	EA	3	*	*	*	*	*	*	*	3-6	1A4A3R6	
P-F	5905-141-0591	RESISTOR, FIXED, COMPOSITION RC20GF103K (81349)	EA	REF	*	*	*	*	*	*	*	3-6	1A4A3R10	
P-F	5905-141-0591	RESISTOR, FIXED, COMPOSITION RC20GF103K (81349)	EA	REF	*	*	*	*	*	*	*	3-6	1A4A3R31	
P-F	5905-106-1273	RESISTOR, FIXED, COMPOSITION RC20GF153J (81349)	EA	3	*	*	*	*	*	*	*	3-6	1A4A3R4	
P-F	5905-106-1273	RESISTOR, FIXED, COMPOSITION RC20GF153J (81349)	EA	REF	*	*	*	*	*	*	*	3-6	1A4A3R22	
P-F	5905-106-1273	RESISTOR, FIXED, COMPOSITION RC20GF153J (81349)	EA	REF	*	*	*	*	*	*	*	3-6	1A4A3R29	
P-F	5905-295-3410	RESISTOR, FIXED, COMPOSITION RC20GF473K (81349)	EA	2	*	*	*	*	*	*	*	3-6	1A4A3R7	
P-F	5905-295-3410	RESISTOR, FIXED, COMPOSITION RC20GF473K (81349)	EA	REF	*	*	*	*	*	*	*	3-6	1A4A3R9	

SECTION III REPAIR PARTS FOR DIRECT SUPPORT, GENERAL SUPPORT, AND DEPOT MAINTENANCE (CONTINUED)

(1) SR CODE	(2) FEDERAL STOCK NUMBER	(3) DESCRIPTION  USABLE ON CODE	(4) UNIT OF MEAS	(5) QTY INC IN UNIT	(6) 30-DAY DS MAINT ALLOWANCE			(7) 30-DAY GS MAINT ALLOWANCE			(8) 1 YR ALW PER EQUIP CMTGTY	(9) DEPOT MAINT ALW PER 100 EQUIP	(10) ILLUSTRATIONS	
					(a) 1-20	(b) 21-50	(c) 51-100	(a) 1-20	(b) 21-50	(c) 51-100			(a) FIG NO.	(b) ITEM NO. OR REFERENCE DESIGNATION
XI-F		CLAMP, CABLE 541-1021-002 (13499)	EA	2										
P-F	5905-369-6923	RESISTOR, FIXED, COMPOSITION RC32GF222K (81349)	EA	1	*	*	*	*	*	*	*	3-6	1A4A3R13	
P-F	5905-299-2016	RESISTOR, FIXED, COMPOSITION RC32GF392K (81349)	EA	1	*	*	*	*	*	*	*	3-6	1A4A3R14	
P-F	5905-299-2014	RESISTOR, FIXED, COMPOSITION RC32GF472K (81349)	EA	1	*	*	*	*	*	*	*	3-6	1A4A3R5	
P-F	5910-729-5239	CAPACITOR, FIXED, MICA DIELECTRIC M42000 (53021)	EA	2	*	*	*	*	*	*	*	3-6	1A4A3C22	
P-F	5910-726-5239	CAPACITOR, FIXED, MICA DIELECTRIC M42000 (53021)	EA	REF	*	*	*	*	*	*	*	3-6	1A4A3C38	
P-F	5910-823-1308	CAPACITOR, FIXED, MICA DIELECTRIC 22H5Q22CJ (14655)	EA	2	*	*	*	*	*	*	*	3-6	1A4A3C6	
P-F	5910-823-1308	CAPACITOR, FIXED, MICA DIELECTRIC 22H5Q22CJ (14655)	EA	REF	*	*	*	*	*	*	*	3-6	1A4A3C33	
P-F	5910-762-2945	CAPACITOR, FIXED, MICA DIELECTRIC 22H5T47EG (14655)	EA	2	*	*	*	*	*	*	*	3-6	1A4A3C24	
P-F	5910-762-2945	CAPACITOR, FIXED, MICA DIELECTRIC 22H5T47EG (14655)	EA	REF	*	*	*	*	*	*	*	3-6	1A4A3C25	
P-F	5910-060-9616	CAPACITOR, FIXED, MICA DIELECTRIC 22H5T51EG (14655)	EA	1	*	*	*	*	*	*	*	3-6	1A4A3C20	
P-F	5910-678-5306	CAPACITOR, FIXED, CERAMIC DIELECTRIC DA049-123B (71590)	EA	6	*	*	*	*	*	*	*	3-6	1A4A3C5	
P-F	5910-678-5306	CAPACITOR, FIXED, CERAMIC DIELECTRIC DA049-123B (71590)	EA	REF	*	*	*	*	*	*	*	3-6	1A4A3C9	
P-F	5910-678-5306	CAPACITOR, FIXED, CERAMIC DIELECTRIC DA049-123B (71590)	EA	REF	*	*	*	*	*	*	*	3-6	1A4A3C10	
P-F	5910-678-5306	CAPACITOR, FIXED, CERAMIC DIELECTRIC DA049-123B (71590)	EA	REF	*	*	*	*	*	*	*	3-6	1A4A3C13	
P-F	5910-678-5306	CAPACITOR, FIXED, CERAMIC DIELECTRIC DA049-123B (71590)	EA	REF	*	*	*	*	*	*	*	3-6	1A4A3C16	
P-F	5910-678-5306	CAPACITOR, FIXED, CERAMIC DIELECTRIC DA049-123B (71590)	EA	REF	*	*	*	*	*	*	*	3-6	1A4A3C17	
P-F	5910-681-7617	CAPACITOR, FIXED, CERAMIC DIELECTRIC 331026COK0209C (72982)	EA	2	*	*	*	*	*	*	*	3-6	1A4A3C32	
P-F	5910-681-7617	CAPACITOR, FIXED, CERAMIC DIELECTRIC 331026COK0209C (72982)	EA	REF	*	*	*	*	*	*	*	3-6	1A4A3C34	
P-F	5910-663-5780	CAPACITOR, FIXED, MICA DIELECTRIC 22H5Q39DJ (14655)	EA	1	*	*	*	*	*	*	*	3-6	1A4A3C15	
P-F	5910-649-0295	CAPACITOR, FIXED, PAPER DIELECTRIC 186P10402S15 (56289)	EA	3	*	*	*	*	*	*	*	3-6	1A4A3C21	
P-F	5910-649-0295	CAPACITOR, FIXED, PAPER DIELECTRIC 186P10402S15 (56289)	EA	REF	*	*	*	*	*	*	*	3-6	1A4A3C23	
P-F	5910-649-0295	CAPACITOR, FIXED, PAPER DIELECTRIC 186P10402S15 (56289)	EA	REF	*	*	*	*	*	*	*	3-6	1A4A3C28	
P-F	5910-951-2415	CAPACITOR, FIXED, PAPER DIELECTRIC 186P1040IT15 (56289)	EA	1	*	*	*	*	*	*	*	3-6	1A4A3C26	
P-F	5910-519-6124	CAPACITOR, FIXED, PAPER DIELECTRIC 186P10402T15 (56289)	EA	1	*	*	*	*	*	*	*	3-6	1A4A3C31	
P-F	5310-058-3599	WASHER, LOCK MS35335-57 (96900)	EA	REF	*	*	*	*	*	*	*			
P-F	5905-102-2740	RESISTOR, FIXED, COMPOSITION RC32GF332K (81349)	EA	1	*	*	*	*	*	*	*	3-6	1A4A3R23	

SECTION III REPAIR PARTS FOR DIRECT SUPPORT, GENERAL SUPPORT, AND DEPOT MAINTENANCE (CONTINUED)

(1) SQ CODE	(2) FEDERAL STOCK NUMBER	(3) DESCRIPTION  REFERENCE NUMBER & MFR. CODE	(4) UNIT OF MEAS	(5) QTY INC IN UNIT	(6) 30-DAY DS MAINT ALLOWANCE			(7) 30-DAY GS MAINT ALLOWANCE			(8) 1 YR ALW PER EQUIP CWTGTY	(9) DEPOT MAINT ALW PER 100 EQUIP	(10) ILLUSTRATIONS	
					(a) 1-20	(b) 21-50	(c) 51-100	(a) 1-20	(b) 21-50	(c) 51-100			(a) FIG NO.	(b) ITEM NO. OR REFERENCE DESIGNATION
P-F		TERMINAL, STUD 2B10B12 (92825)	EA	REF	*	*	*	*	*	*	*			
P-F	5305-054-5646	SCREW, MACHINE MS51957-12 (96906)	EA	REF	*	*	*	*	*	*	*			
P-F	5910-542-7387	CAPACITOR, FIXED, ELECTROLYTIC 150D475X0035B2 (56289)	EA	1	*	*	*	*	*	*	*	3-6	1A4A3C40	
P-F	5905-254-7097	RESISTOR, FIXED, COMPOSITION RC20GF823K (81349)	EA	1	*	*	*	*	*	*	*	3-6	1A4A3R32	
P-F		NUT, BLIND, RIVET MS27130-2 (96906)	EA	1	*	*	*	*	*	*	*			
P-F	5305-054-5637	SCREW, MACHINE MS21957-3 (96906)	EA	26	*	*	*	*	*	*	*			
P-F	5310-058-3829	WASHER, LOCK MS35338-77 (96906)	EA	REF	*	*	*	*	*	*	*			
P-F		NUT, PLAIN, HEXAGON P334-0254-000 (77250)	EA	REF	*	*	*	*	*	*	*			
P-F		WASHER, LOCK 1218-02CADPL (78189)	EA	11	*	*	*	*	*	*	*			
P-F	5909-2999-2033	RESISTOR, FIXED, COMPOSITION RC32GF682K (81349)	EA	1	*	*	*	*	*	*	*	3-6	1A4A3R2	
P-F	5305-054-5649	SCREW, MACHINE MS51957-15 (96906)	EA	REF	*	*	*	*	*	*	*			
P-F		TERMINAL, LUG SPL4040-2HOTFINNED (77147)	EA	2	*	*	*	*	*	*	*			
M-H		INSULATION SLEEVING, ELECTRICAL TEFTW16B (81851)	FT	5										
P-F	5310-271-4640	NUT, PLAIN, HEXAGON MS35649-24 (96906)	EA	REF	*	*	*	*	*	*	*			
X2-F		BRACE, RIGHT 543-1666-002 (13499)	EA	1										
P-F	5310-918-7213	NUT, CAPTIVE NCM4-2-2-1 (07886)	EA	REF	*	*	*	*	*	*	*			
X2-F		BRACE, RIGHT 543-1674-002 (13499)	EA	1										
P-F		NUT, BLIND, RIVET MS27130-6 (96906)	EA	1	*	*	*	*	*	*	*			
P-D		POST CABLE 543-1668-002 (13499)	EA	1							*			
A-F		WIRING HARNESS 546-7889-000 (13499)	EA	1										
M-H		INSULATION SLEEVING, ELECTRICAL TEFTW20B (81851)	FT	REF										
P-F	5950-647-9291	COIL, RADIO FREQUENCY 18-119 (09250)	EA	2	*	*	*	*	*	*	*	3-6	1A4A3L1	
P-F	5950-647-9291	COIL, RADIO FREQUENCY 18-119 (09250)	EA	REF	*	*	*	*	*	*	*	3-6	1A4A3L6	
P-F	5935-257-8683	CONNECTOR, RECEPTACLE, ELECTRICAL 126-1082 (02660)	EA	1	*	*	*	*	*	*	*	3-6	1A4A3J7	
P-F	5935-552-3850	CONNECTOR, RECEPTACLE, ELECTRICAL 600-120-1XA (95238)	EA	1	*	*	*	*	*	*	*	3-6	1A4A3J1	
P-F	5935-687-1886	CONNECTOR, RECEPTACLE, ELECTRICAL 3990-200 (09922)	EA	5	*	*	*	*	*	*	*	3-6	1A4A3J4	
P-F	5935-687-1886	CONNECTOR, RECEPTACLE, ELECTRICAL 3990-200 (09922)	EA	REF	*	*	*	*	*	*	*	3-6	1A4A3J5	

SECTION III REPAIR PARTS FOR DIRECT SUPPORT, GENERAL SUPPORT, AND DEPOT MAINTENANCE (CONTINUED)

(1) SR CODE	(2) FEDERAL STOCK NUMBER	(3) DESCRIPTION  USABLE ON CODE	(4) UNIT OF MEAS	(5) QTY INC IN UNIT	(6) 30-DAY DS MAINT ALLOWANCE			(7) 30-DAY GS MAINT ALLOWANCE			(8) 1 YR ALW PER EQUIP CMTCTY	(9) DEPOT MAINT ALW PER 100 EQUIP	(10) ILLUSTRATIONS	
					(a) 1-20	(b) 21-50	(c) 51-100	(a) 1-20	(b) 21-50	(c) 51-100			(a) FIG NO.	(b) ITEM NO. OR REFERENCE DESIGNATION
P-F	5935-687-1886	CONNECTOR, RECEPTACLE, ELECTRICAL 3990-200 (09922)	EA	REF	*	*	*	*	*	*	*	*		1A4A3J6
P-F	5935-687-1886	CONNECTOR, RECEPTACLE, ELECTRICAL 3990-200 (09922)	EA	REF	*	*	*	*	*	*	*	*	3-6	1A4A3J8
P-F	5935-687-1886	CONNECTOR, RECEPTACLE, ELECTRICAL 3990-200 (09922)	EA	REF	*	*	*	*	*	*	*	*	3-6	1A4A3J9
M-H		CABLE, RADIO FREQUENCY RG196AU (80058)	FT	REF										
M-H		WIRE, ELECTRICAL 00702-1322 (70567)	FT	REF										
M-H		WIRE, ELECTRICAL WTE734ACW0 (90484)	FT	6										
M-H		WIRE, ELECTRICAL WTE734ACW1 (90484)	FT	4										
M-H		WIRE, ELECTRICAL WTE734ACW916 (90484)	FT	2										
M-H		WIRE, ELECTRICAL WTE734ACW926 (90484)	FT	5										
M-H		WIRE, ELECTRICAL WTE734ACW903 (90484)	FT	7										
M-H		WIRE, ELECTRICAL WTE734ACW92 (90484)	FT	REF										
M-H		WIRE, ELECTRICAL MILW16878TYPE22-91 (81349)	FT	7										
M-H		WIRE, ELECTRICAL MILW16878TYPE22-90 (81349)	FT	8										
M-H		CABLE, SPECIAL PURPOSE, ELECTRICAL TE26-734CWS925 (05973)	FT	3										
M-H		CABLE, SPECIAL PURPOSE, ELECTRICAL TE26-734CWS935 (05973)	FT	2										
P-F	5905-141-0591	RESISTOR, FIXED, COMPOSITION RC20GF10K (81349)	EA	REF	*	*	*	*	*	*	*	*	3-6	1A4A3R28
P-F	5910-800-0357	CAPACITOR, FIXED, PAPER DIELECTRIC 186P15391S3 (56289)	EA	2	*	*	*	*	*	*	*	*	3-6	1A4A3C2
P-F	5910-800-0357	CAPACITOR, FIXED, PAPER DIELECTRIC 186P15391S3 (56289)	EA	REF	*	*	*	*	*	*	*	*	3-6	1A4A3C39
M-H		BRAID, WIRE 36062 (75818)	FT	3										
P-F		NUT, PLAIN 243-1656-002 (13499)	EA	1	*	*	*	*	*	*	*	*		
P-F		NUT, PLAIN, HEXAGON P313-0132-000 (77250)	EA	REF	*	*	*	*	*	*	*	*		
P-F	5310-042-9609	WASHER, LOCK MS35338-78 (96906)	EA	REF	*	*	*	*	*	*	*	*		
P-F		TERMINAL, LUG 4007-4HOTINNED (77147)	EA	REF	*	*	*	*	*	*	*	*		
P-F	5935-686-3635	CONNECTOR, RECEPTACLE, ELECTRICAL DC37P (71468)	EA	1	*	*	*	*	*	*	*	*	3-6	1A4A3P1
M-H		INSULATION SLEEVING, ELECTRICAL TEFTW14B (81851)	FT	REF										
M-H		TAPE, COATED CLOTH GUDELACE18 (82110)	FT	708										
M-H		WIRE, ELECTRICAL WTE734ACW925 (90484)	FT	2										

SECTION III REPAIR PARTS FOR DIRECT SUPPORT, GENERAL SUPPORT, AND DEPOT MAINTENANCE (CONTINUED)

(1) SR CODE	(2) FEDERAL STOCK NUMBER	(3) DESCRIPTION	(4) USABLE ON CODE	(5) UNIT OF MEAS	(6) QTY INC IN UNIT	(7) 30-DAY DS MAINT ALLOWANCE			(8) 30-DAY GS MAINT ALLOWANCE			(9) 1 YR ALW PER EQUIP CNTGTY	(10) DEPOT MAINT ALW PER 100 EQUIP	(11) ILLUSTRATIONS	
						(a)	(b)	(c)	(a)	(b)	(c)			(a)	(b)
						1-20	21-50	51-100	1-20	21-50	51-100			FIG NO.	ITEM NO. OR REFERENCE DESIGNATION
P-F		TERMINAL, LUG 2104-06-02-2520N (78189)		EA	REF	*	*	*	*	*	*	*			
M-H		CABLE, SPECIAL PURPOSE, ELECTRICAL TE26-734CWS0 (05973)		FT	1										
M-H		CABLE, SPECIAL PURPOSE, ELECTRICAL TE26-734CWS96 (05973)		FT	1										
P-F	5910-822-5233	CAPACITOR, FIXED, CERAMIC DIELECTRIC 20C109 (01939)		EA	1	*	*	*	*	*	*	*	*		1A4A3C43
M-H		CABLE, RADIO FREQUENCY 14266 (90484)		FT	1										
M-H		INSULATION SLEEVING, ELECTRICAL TEFTW10B (81851)		FT	REF										
M-H		INSULATION SLEEVING, ELECTRICAL TEFTW13B (81851)		FT	4										
M-H		INSULATION SLEEVING, ELECTRICAL TEFTW15B (81851)		FT	2										
P-F	5950-807-3425	COIL, RADIO FREQUENCY 2500-76 (99800)		EA	1	*	*	*	*	*	*	*	*		1A4A3J9
P-F	5910-847-7288	CAPACITOR, FIXED CERAMIC DIELECTRIC CK06CW10K (81349)		EA	1	*	*	*	*	*	*	*	*		1A4A3C44
P-F		EYELET, METALLIC SE23HOTINNED (61957)		EA	25	*	*	*	*	*	*	*	*		
M-H		INSULATION SLEEVING, ELECTRICAL RNF100 1-8BLK (08795)		FT	1										
A-H		ARM, SHORT 543-1678-002 (13499)		EA	2										
P-H		NUT, SLEEVE-CORE 543-1625-002 (13499)		EA	5				*	*	*	*	*		
P-H		ARM, SLUG, ADJUSTABLE 543-1629-002 (13499)		EA	2				*	*	*	*	*		
A-H		ARM, STAKED 543-1679-002 (13499)		EA	1										
P-H		NUT, SLEEVE-CORE 543-1625-002 (13499)		EA	REF				*	*	*	*	*		
P-H		ARM, SLUG, ADJUSTABLE 543-1631-002 (13499)		EA	3				*	*	*	*	*		
A-H		ARM, STAKED, LEFT 543-1680-002 (13499)		EA	2										
P-H		NUT, SLEEVE-CORE 543-1625-002 (13499)		EA	REF				*	*	*	*	*		
P-H		ARM, SLUG 543-1631-002 (13499)		EA	REF				*	*	*	*	*		
X2-H		RETAINER, TAPE 543-1671-002 (13499)		EA	2										
A-F		TERMINAL BOARD 545-7879-003 (13499)		EA	1										
P-H	5320-117-6938	RIVET, SOLID MS20426AD3-4 (96906)		EA	24				*	*	*	*	*		
P-F	5910-918-7213	NUT, CAPTIVE NCG4-2-2-1 (07886)		EA	REF	*	*	*	*	*	*	*	*		
X2-F		PARTITION, REAR 545-7877-003 (13499)		EA	1										
X2-F		BRACKET, ANGLE 543-6014-002 (13499)		EA	1										

SECTION III REPAIR PARTS FOR DIRECT SUPPORT, GENERAL SUPPORT, AND DEPOT MAINTENANCE (CONTINUED)

(1) SIR CODE	(2) FEDERAL STOCK NUMBER	(3) DESCRIPTION	(4) UNIT OF MEAS	(5) QTY INC IN UNIT	(6) 30-DAY DS MAINT ALLOWANCE			(7) 30-DAY GS MAINT ALLOWANCE			(8) 1 YR ALW PER EQUIP CNTGCT	(9) DEPOT MAINT ALW PER 100 EQUIP	(10) ILLUSTRATIONS			
					USABLE ON CODE	REF	*	*	*	*			*	*	3-6	ITEM NO. OR REFERENCE DESIGNATION
X2-F		BRACKET, ANGLE 543-6015-002 (13499)	EA	1												
X2-F		PLATE, RETAINING 543-1685-002 (13499)	EA	1												
P-F	3110-447-4775	BEARING, BALL, ANNULAR S5632FCHHP37L02 (40920)	EA	REF	*	*	*	*	*	*	*					
P-F		BEARING, BALL, ANNULAR S5632FRRH38509P15L02 (40920)	EA	1	*	*	*	*	*	*	*					
X2-F		PLATE, RETAINING 543-1632-002 (13499)	EA	1												
X2-F		PLATE, CASTING 543-1632-012 (13499)	EA	1												
X1-F		HUP 543-1633-002 (13499)	EA	REF												
X2-F		PLATE, DOWEL 543-1686-002 (13499)	EA	1												
P-H		PIN, LOCATING 540-7766-002 (13499)	EA	16				*	*	*	*	*				
X2-F		PLATE, DOWEL 543-1641-003 (13499)	EA	1												
X2-F		CASTING, PLATE 43-1641-013 (13499)	EA	1												
A-H		PULLEY-TOP 543-1688-002 (13499)	EA	2								3-6	1A4A3MP13			
A-H		PULLEY-TOP 543-1688-002 (13499)	EA	REF								3-6	1A4A3MP24			
P-H		BEARING, BALL ANNULAR 77R4DXRIKA (43334)	EA	1				*	*	*	*	3-6	1A4A3MP14			
P-F	5315-291-5471	PIN, SPRING MS16562-189 (96906)	EA	REF	*	*	*	*	*	*	*					
X1-F		LINER, PULLEY 543-1673-002 (13499)	EA	2												
P-F	5821-679-9372	COIL, RADIO FREQUENCY 543-1771-003 (13499)	EA	1	*	*	*	*	*	*	*	3-6	1A4A3Z1			
P-F		TERMINAL, FEEDTHRU G5687 (12615)	EA	80	*	*	*	*	*	*	*					
M-H		WIRE, ELECTRICAL ANALAC28AWG (81554)	FT	30												
X1-F		SHIELD, COIL 543-1621-002 (13499)	EA	7												
X1-F		CAN, SHIELD 938XL188 (83722)	EA	35												
X2-F		FRAME, COIL 543-7882-003 (13499)	EA	33												
X1-F		COIL, RADIO FREQUENCY 543-1753-002 (13499)	EA	1								3-6	1A4A3T1			
X1-F		WIRE, ELECTRICAL 642FN (74116)	FT	6												
X1-F		FORM, COIL 506-0195-002 (13499)	EA	35												
P-H	5910-932-2738	CAPACITOR, FIXED, MICA DIELECTRIC 22H5Q82EG (14655)	EA	1				*	*	*	*	3-6	1A4A3C4			
P-H	5910-542-1427	CAPACITOR, VARIABLE 2172000U2P034R (72982)	EA	1				*	*	*	*	3-6	1A4A3C3			

SECTION III REPAIR PARTS FOR DIRECT SUPPORT, GENERAL SUPPORT, AND DEPOT MAINTENANCE (CONTINUED)

(1) SIR CODE	(2) FEDERAL STOCK NUMBER	(3) DESCRIPTION  USABLE ON CODE	(4) UNIT OF MEAS	(5) QTY INC IN UNIT	(6) 30-DAY DS MAINT ALLOWANCE			(7) 30-DAY GS MAINT ALLOWANCE			(8) 1 YR ALW PER EQUIP (NTGTY)	(9) DEPOT MAINT ALW PER 100 EQUIP	(10) ILLUSTRATIONS	
					(a)	(b)	(c)	(a)	(b)	(c)			(a)	(b)
					1-20	21-50	51-100	1-20	21-50	51-100			FIG NO.	ITEM NO. OR REFERENCE DESIGNATION
P-H		TERMINAL, FEEDTHRU 5484 (12615)	EA	28				*	*	*	*	*		
P-F	5935-615-8555	JACK, TIP SKT5BCWHT (98291)	EA	3	*	*	*	*	*	*	*	*	3-6	1A4A3J13
P-F	5821-729-5479	COIL, RADIO FREQUENCY 545-5840-003 (13499)	EA	1	*	*	*	*	*	*	*	*	3-6	1A4A3J22
P-F		TERMINAL, FEEDTHRU 05687 (12615)	EA	REF	*	*	*	*	*	*	*	*		
M-H		WIRE, ELECTRICAL ANALAC30AWG (81554)	FT	10										
XL-F		SHIELD, COIL 543-1621-002 (13499)	EA	REF										
XL-F		CAN, SHIELD 938XL188 (83722)	EA	REF										
X2-F		FRAME, COIL 543-7882-003 (13499)	EA	REF										
XL-F		COIL, RADIO FREQUENCY 543-1690-002 (13499)	EA	1									3-6	1A4A3J22
M-H		WIRE, ELECTRICAL ANALAC32AWG (81554)	FT	43										
XL-H		FORM, COIL 506-0195-002 (13499)	EA	REF										
P-H		TERMINAL, LUG 506-1372-002 (13499)	EA	68				*	*	*	*	*		
P-H	5910-752-4615	CAPACITOR, VARIABLE 3172000C0P039R (72982)	EA	1				*	*	*	*	*	3-6	1A4A3C7
P-H	5910-832-5724	CAPACITOR, FIXED, MICA DIELECTRIC 22H9Q68EG (14655)	EA	1				*	*	*	*	*	3-6	1A4A3C8
P-H		TERMINAL, FEEDTHRU 5684 (12615)	EA	REF				*	*	*	*	*		
P-F	5935-615-8555	JACK, TIP SKT5BCWHT (98291)	EA	REF	*	*	*	*	*	*	*	*	3-6	1A4A3J3
P-H		SPACER, LINK 545-3056-002 (13499)	EA	2				*	*	*	*	*		
P-F	5802-771-0951	COIL, RADIO FREQUENCY 544-7236-003 (13499)	EA	1	*	*	*	*	*	*	*	*	3-6	1A4A3J3
P-F		TERMINAL, FEEDTHRU 05687 (12615)	EA	REF	*	*	*	*	*	*	*	*		
XL-F		SHIELD, COIL 543-1621-002 (13499)	EA	REF										
XL-F		CAN, SHIELD 938XL188 (83722)	EA	REF										
X2-F		FRAME, COIL 543-7882-003 (13499)	EA	REF										
XL-F		COIL, RADIO FREQUENCY 543-1691-002 (13499)	EA	1										
M-H		WIRE, ELECTRICAL ANALAC26AWG (81554)	FT	18										
XL-H		FORM, COIL 506-0195-002 (13499)	EA	REF										
P-H		TERMINAL, LUG 506-1372-002 (13499)	EA	REF				*	*	*	*	*		
P-H	5910-850-9066	CAPACITOR, FIXED, MICA DIELECTRIC 22H5Q15CJ (14655)	EA	1				*	*	*	*	*	3-6	1A4A3C11

SECTION III REPAIR PARTS FOR DIRECT SUPPORT, GENERAL SUPPORT, AND DEPOT MAINTENANCE (CONTINUED)

(1) SIR CODE	(2) FEDERAL STOCK NUMBER	(3) DESCRIPTION  USABLE ON CODE	(4) UNIT OF MEAS	(5) QTY INC IN UNIT	(6) 30-DAY DC MAINT ALLOWANCE			(7) 30-DAY GS MAINT ALLOWANCE			(8) 1 YR ALW PER EQUIP CNTGCTY	(9) DEPOT MAINT ALW PER 100 EQUIP	(10) ILLUSTRATIONS	
					(a) 1-20	(b) 21-50	(c) 51-100	(a) 1-20	(b) 21-50	(c) 51-100			(a) FIG NO.	(b) ITEM NO., OR REFERENCE DESIGNATION
P-H	5910-686-6919	CAPACITOR, VARIABLE 31720000P017R (72982)	EA	1				*	*	*	*	*	3-6	1A4A3C12
P-F	5935-615-8555	JACK, TIP SKT9BCWHT (98291)	EA	REF	*	*	*	*	*	*	*	*	3-6	1A4A3J12
P-H	5910-678-5079	CAPACITOR, FIXED, MICA DIELECTRIC 32H5Q1CJ (14655)	EA	1				*	*	*	*	*	3-6	1A4A3C14
P-F	5821-679-9375	COIL, RADIO FREQUENCY 543-1775-003 (13499)	EA	1	*	*	*	*	*	*	*	*	3-6	1A4A3Z4
P-F		TERMINAL, FEEDTHRU G5687 (12615)	EA	REF	*	*	*	*	*	*	*	*		
X1-F		SHIELD, COIL 54C-7617-002 (13499)	EA	28										
X1-F		CAN, SHIELD 938X1188 (83722)	EA	REF										
X2-F		FRAME, COIL 543-7882-003 (13499)	EA	REF										
X1-F		COIL, RADIO FREQUENCY 543-1692-002 (13499)	EA	2									3-6	1A4A3L4
M-H		WIRE, ELECTRICAL ANALAC28AWG (81554)	FT	REF										
X1-H		FORM, COIL 506-0195-002 (13499)	EA	REF										
P-H		TERMINAL, LUG 506-1372-002 (13499)	EA	REF				*	*	*	*	*		
P-H	5910-195-5392	CAPACITOR, FIXED, CERAMIC DIELECTRIC DA934-008 (71590)	EA	2				*	*	*	*	*	3-6	1A4A3C29
P-H	5910-667-6637	CAPACITOR, VARIABLE 3188001 (72982)	EA	2				*	*	*	*	*	3-6	1A4A3C30
P-F	5821-679-9376	COIL, RADIO FREQUENCY 543-1776-003 (13499)	EA	1	*	*	*	*	*	*	*	*	3-6	1A4A3Z5
P-F		TERMINAL, FEEDTHRU G5687 (12615)	EA	REF	*	*	*	*	*	*	*	*		
X1-F		SHIELD, COIL 54C-7617-002 (13499)	EA	REF										
X1-F		CAN, SHIELD 938X1188 (83722)	EA	REF										
X2-F		FRAME, COIL 543-7882-003 (13499)	EA	REF										
X1-F		COIL, RADIO FREQUENCY 543-1692-002 (13499)	EA	REF										
M-H		WIRE, ELECTRICAL ANALAC28AWG (81554)	FT	REF										
X1-H		FORM, COIL 506-0195-002 (13499)	EA	REF										
P-H		TERMINAL, LUG 506-1372-002 (13499)	EA	REF				*	*	*	*	*		
P-H	5910-195-5392	CAPACITOR, FIXED, CERAMIC DIELECTRIC DA934-008 (71590)	EA	REF				*	*	*	*	*	3-6	1A4A3C35
P-H	5910-667-6637	CAPACITOR, VARIABLE 3188001 (72982)	EA	REF				*	*	*	*	*	3-6	1A4A3C36
P-F	5915-679-9363	FILTER, BANDPASS 543-1781-003 (13499)	EA	1	*	*	*	*	*	*	*	*	3-6	1A4A3F11
X1-F		COIL, RADIO FREQUENCY 543-1779-003 (13499)	EA	2										1A4A3L6



SECTION III REPAIR PARTS FOR DIRECT SUPPORT, GENERAL SUPPORT, AND DEPOT MAINTENANCE (CONTINUED)

(1) SR CODE	(2) FEDERAL STOCK NUMBER	(3) DESCRIPTION  USABLE ON CODE	(4) UNIT OF MEAS	(5) QTY INC IN UNIT	(6) 30-DAY DS MAINT ALLOWANCE			(7) 30-DAY GS MAINT ALLOWANCE			(8) 1 YR ALW PER EQUIP CNTGCT	(9) DEPOT MAINT ALW PER 100 EQUIP	(10) ILLUSTRATIONS	
					(a)	(b)	(c)	(a)	(b)	(c)			(a)	(b)
					1-20	21-50	51-100	1-20	21-50	51-100			FIG NO.	ITEM NO. OR REFERENCE DESIGNATION
XI-F		COIL, RADIO FREQUENCY 543-1779-003 (13499)	EA	REF										1A4A3L9
P-H		FORM, COIL LS11-2W (71279)	EA	5				*	*	*	*	*		
M-H		WIRE, ELECTRICAL 744PM (74116)	FT	69										
M-H		-OR- WIRE, ELECTRICAL 422-0065-000 (13499)	FT	69										
XI-F		COIL, RADIO FREQUENCY 543-1780-003 (13499)	EA	2									3-6	1A4A3L7
XI-F		COIL, RADIO FREQUENCY 543-1780-003 (13499)	EA	REF									3-6	1A4A3L8
P-H		FORM, COIL LS11-2W (71279)	EA	REF				*	*	*	*	*		
M-H		WIRE, ELECTRICAL 744PM (74116)	FT	REF										
M-H		-OR- WIRE, ELECTRICAL 422-0065-000 (13499)	FT	REF										
X2-H		BRACKET, FILTER 543-1706-002 (13499)	EA	2										
P-F		TERMINAL, FEEDTHRU G5687 (12615)	EA	REF	*	*	*	*	*	*	*	*		
X2-H		BRACKET, FILTER 543-1702-002 (13499)	EA	2										
X2-H		BRACKET, FILTER 543-1704-002 (13499)	EA	2										
X2-H		BRACKET, FILTER 543-1701-002 (13499)	EA	2										
X1-H		FASTENER, ANGLE 904-7698-002 (13499)	EA	14										
X2-H		PARTITION 543-1703-002 (13499)	EA	2										
P-F		TERMINAL, STUD 1985 (12615)	EA	REF	*	*	*	*	*	*	*	*		
P-H	5910-729-9294	CAPACITOR, FIXED, MICA DIELECTRIC 22H5Q51E5 (14655)	EA	1				*	*	*	*	*	3-6	1A4A3C66
P-H	5910-932-2738	CAPACITOR, FIXED, MICA DIELECTRIC 22H5Q82E5 (14655)	EA	REF				*	*	*	*	*		1A4A3C60
P-H	5910-681-7140	CAPACITOR, FIXED, MICA DIELECTRIC 22H5T18E5 (14655)	EA	2				*	*	*	*	*		1A4A3C62
P-H	5910-681-7240	CAPACITOR, FIXED, MICA DIELECTRIC 22H5T18E5 (14655)	EA	REF				*	*	*	*	*		1A4A3C64
P-H	5910-726-2448	CAPACITOR, FIXED, CERAMIC DIELECTRIC 331026G0H0509C (72982)	EA	3				*	*	*	*	*	3-6	1A4A3C61
P-H	5910-726-2448	CAPACITOR, FIXED, CERAMIC 331026G0H0509C (72982)	EA	REF				*	*	*	*	*		1A4A3C63
P-H	5910-726-2448	CAPACITOR, FIXED, CERAMIC 331026G0H0509C (72982)	EA	REF				*	*	*	*	*		1A4A3C65
M-H		WIRE, ELECTRICAL 00702-1320 (70567)	FT	REF										
X2-H		COVER, FILTER 543-1705-002 (13499)	EA	1										
X2-H		SHIELD 141-0230-000 (13499)	EA	1										
P-F	5305-777-6039	SCREW, MACHINE MS51959-12 (96906)	EA	REF	*	*	*	*	*	*	*	*		
P-F	5305-054-5646	SCREW, MACHINE MS51957-12 (96906)	EA	REF	*	*	*	*	*	*	*	*		

SECTION III REPAIR PARTS FOR DIRECT SUPPORT, GENERAL SUPPORT, AND DEPOT MAINTENANCE (CONTINUED)

(1) SNR CODE	(2) FEDERAL STOCK NUMBER	(3) DESCRIPTION  USABLE ON CODE	(4) UNIT OF MEAS	(5) QTY INC IN UNIT	(6) 30-DAY DS MAINT ALLOWANCE			(7) 30-DAY GS MAINT ALLOWANCE			(8) 1 YR ALLOW PER EQUIP CNTGTY	(9) DEPOT MAINT ALLOW PER 100 EQUIP	(10) ILLUSTRATIONS	
					(a)	(b)	(c)	(a)	(b)	(c)			(a)	(b)
					1-20	21-50	51-100	1-20	21-50	51-100			FIG NO.	ITEM NO. OR REFERENCE DESIGNATION
P-F	5310-042-9609	WASHER, LOG MS35338-7 (96906)	EA	REF	*	*	*	*	*	*	*	*		
P-H	5820-987-3554	MIXER STAGE 547-3766-004 (13499)	EA	1	*	*	*	*	*	*	*	*		1A4A3A3
P-H	5910-717-0169	CAPACITOR, FIXED, MICA DIELECTRIC 22H5T1EG (14655)	EA	1	*	*	*	*	*	*	*	*	3-7	1A4A3A3C10
P-H	5910-725-1993	CAPACITOR, FIXED, MICA DIELECTRIC 22H5T2EG (14655)	EA	1	*	*	*	*	*	*	*	*	3-7	1A4A3A3C11
P-H	5910-728-1877	CAPACITOR, FIXED, MICA DIELECTRIC 22H5T3EG (14655)	EA	1	*	*	*	*	*	*	*	*	3-7	1A4A3A3C8
P-H	5850-583-0922	TRANSFORMER, INTERMEDIATE FREQUENCY X061-1 (81815)	EA	1	*	*	*	*	*	*	*	*	3-7	1A4A3A3T1
P-F	5910-847-7288	CAPACITOR, FIXED, CERAMIC DIELECTRIC C06C0103K (81349)	EA	4	*	*	*	*	*	*	*	*	3-7	1A4A3A3C1
P-F	5910-847-7288	CAPACITOR, FIXED, CERAMIC DIELECTRIC C06C0103K (81349)	EA	REF	*	*	*	*	*	*	*	*	3-7	1A4A3A3C3
P-F	5910-847-7288	CAPACITOR, FIXED, CERAMIC DIELECTRIC C06C0103K (81349)	EA	REF	*	*	*	*	*	*	*	*	3-7	1A4A3A3C6
P-F	5910-8477288	CAPACITOR, FIXED, CERAMIC DIELECTRIC C06C0103K (81349)	EA	REF	*	*	*	*	*	*	*	*	3-7	1A4A3A3C7
P-H	5905-171-2005	RESISTOR, FIXED, COMPOSITION RC20GF471K (81349)	EA	2	*	*	*	*	*	*	*	*	3-7	1A4A3A3R5
P-H	5905-171-2005	RESISTOR, FIXED, COMPOSITION RC20GF471K (81349)	EA	REF	*	*	*	*	*	*	*	*	3-7	1A4A3A3R8
P-H	5905-595-5514	RESISTOR, FIXED, COMPOSITION RC20GF152K (81349)	EA	1	*	*	*	*	*	*	*	*	3-7	1A4A3A3R10
P-H	5905-171-1985	RESISTOR, FIXED, COMPOSITION RC20GF822K (81349)	EA	1	*	*	*	*	*	*	*	*	3-7	1A4A3A3R6
P-F	5905-141-0591	RESISTOR, FIXED, COMPOSITION RC20GF103K (81349)	EA	4	*	*	*	*	*	*	*	*	3-7	1A4A3A3R5
P-F	5905-141-0591	RESISTOR, FIXED, COMPOSITION RC20GF103K (81349)	EA	REF	*	*	*	*	*	*	*	*	3-7	1A4A3A3R9
P-F	5905-106-1273	RESISTOR, FIXED, COMPOSITION RC20GF153K (81349)	EA	1	*	*	*	*	*	*	*	*	3-7	1A4A3A3R11
P-H	5905-190-8882	RESISTOR, FIXED, COMPOSITION RC20GF823K (81349)	EA	1	*	*	*	*	*	*	*	*	3-7	1A4A3A3R4
P-F	5905-295-3410	RESISTOR, FIXED, COMPOSITION RC20GF473K (81349)	EA	1	*	*	*	*	*	*	*	*	3-7	1A4A3A3R7
P-F	5905-254-7097	RESISTOR, FIXED, COMPOSITION RC20GF823K (81349)	EA	1	*	*	*	*	*	*	*	*	3-7	1A4A3A3R2
P-H	5905-192-0667	RESISTOR, FIXED, COMPOSITION RC20GF224K (81349)	EA	1	*	*	*	*	*	*	*	*	3-7	1A4A3A3E1
P-H	5905-054-5636	SCREW, MACHINE M 1957-2 (96906)	EA	74	*	*	*	*	*	*	*	*		
P-H	5310-622-1724	NUT, SELF-LOCKING, HEXAGON 68-1660-26 (72962)	EA	10	*	*	*	*	*	*	*	*		
P-H	5310-614-3500	NUT, SELF-LOCKING, HEXAGON 68-1660-40 (72962)	EA	37	*	*	*	*	*	*	*	*		
P-H	5999-691-0458	PRINTED CIRCUIT BOARD 547-3761-003 (13499)	EA	1	*	*	*	*	*	*	*	*		
P-H	5340-893-5494	CLIP, SPRING TENSION 100-300-16-13 (99378)	EA	3	*	*	*	*	*	*	*	*		
XI-H		RIVET, TUBULAR R3484X5-3CADPL (12014)	EA	9	*	*	*	*	*	*	*	*		

SECTION III REPAIR PARTS FOR DIRECT SUPPORT, GENERAL SUPPORT, AND DEPOT MAINTENANCE (CONTINUED)

(1) SYM CODE	(2) FEDERAL STOCK NUMBER	(3) DESCRIPTION  USABLE ON CODE	(4) UNIT OF MEAS	(5) QTY INC IN UNIT	(6) 30-DAY DS MAINT ALLOWANCE			(7) 30-DAY GS MAINT ALLOWANCE			(8) 1 YR BLW PER EQUIP (NTGCY)	(9) DEPOT MAINT ALW PER 100 EQUIP	(10) ILLUSTRATIONS	
					(a) 1-20	(b) 21-50	(c) 51-100	(a) 1-20	(b) 21-50	(c) 51-100			(a) FIG NO.	(b) ITEM NO. OR REFERENCE DESIGNATION
X1-H		TUBELET 542-0810-003 (13499)	EA	REF										
P-H		SPACER, SLEEVE 543-1707-002 (13499)	EA	4				*	*	*	*			
X1-H		BRACKET 543-1709-002 (13499)	EA	2										
P-H	5310-916-9401	NUT, PLAIN, CLINCHED CL630-10 (46384)	EA	2				*	*	*	*			
P-H		NUT, PLAIN CL630-10 (46384)	EA	2				*	*	*	*			
X1-H		BRACKET 544-1708-001 (13499)	EA	3										
X1-H		PRINTED CIRCUIT BOARD 547-1767-004 (13499)	EA	1										
M-H		WIRE, ELECTRICAL WTECNA (92484)	FT	5										
P-H	5960-557-6126	SHIELD, ELECTRON 1044-01-1 (99372)	EA	4				*	*	*	*			
P-F		INSULATION SLEEVING, ELECTRICAL TEFTW0-8 (21851)	FT	REF	*	*	*	*	*	*	*			
M-H		INSULATION SLEEVING, ELECTRICAL TEFTW0-3 (21851)	FT	11										
M-H		INSULATION SLEEVING, ELECTRICAL TEFTW0-1 (21851)	FT	10										
M-H		INSULATION SLEEVING, ELECTRICAL TEFTW0-6 (21851)	FT	11										
M-H		INSULATION SLEEVING, ELECTRICAL TEFTW0-7 (21851)	FT	1										
M-H		INSULATION SLEEVING, ELECTRICAL TEFTW0-5 (21851)	FT	15										
M-H		INSULATION SLEEVING, ELECTRICAL TEFTW0-4 (21851)	FT	15										
M-H		WIRE, ELECTRICAL 0070-1322 (73667)	FT	REF										
M-H		CABLE, RADIO FREQUENCY H0136AU (20053)	FT	REF										
P-H	5960-230-5226	ELECTRON TUBE 5636 (42219)	EA	2				*	*	*	*	3-7	1A4A3A301	
P-H	5960-230-5226	ELECTRON TUBE 5636 (42219)	EA	REF				*	*	*	*	3-7	1A4A3A301	
P-H	5915-679-9383	FILTER 542-1183-004 (13499)	EA	1				*	*	*	*	3-7	1A4A3A301	
X1-H		INSULATOR, PLATE 549-4410-002 (13499)	EA	4										
X1-H		INSULATOR, PLATE 549-4411-002 (13499)	EA	4										
P-H		CAPACITOR, FIXED, MICA DIELECTRIC K0M5E400-500WV (72136)	EA	3				*	*	*	*		1A4A3A302	
P-H		CAPACITOR, FIXED, MICA DIELECTRIC K0M5E400-500WV (72136)	EA	REF				*	*	*	*		1A4A3A302	
P-H		CAPACITOR, FIXED, MICA DIELECTRIC K0M5E400-500WV (72136)	EA	REF				*	*	*	*		1A4A3A301	
X1-H		SPACER, COIL 554-0672-002 (13499)	EA	4										

SECTION III REPAIR PARTS FOR DIRECT SUPPORT, GENERAL SUPPORT, AND DEPOT MAINTENANCE (CONTINUED)

(1) SR CODE	(2) FEDERAL STOCK NUMBER	(3) DESCRIPTION  USABLE ON CODE	(4) UNIT OF MEAS	(5) QTY INC IN UNIT	(6) 30-DAY DS MAINT ALLOWANCE			(7) 30-DAY GS MAINT ALLOWANCE			(8) 1 YR ALW PER EQUIP CNTGCTY	(9) DEPOT MAINT ALW PER 100 EQUIP	(10) ILLUSTRATIONS	
					(a) 1-20	(b) 21-50	(c) 51-100	(a) 1-20	(b) 21-50	(c) 51-100			(a) FIG NO.	(b) ITEM NO. OR REFERENCE DESIGNATION
X2-H		CASE, FILTER 549-4415-003 (13499)	EA	1										
M-H		WIRE, ELECTRICAL 00702-1322 (70567)	FT	REF										
P-H		COIL, RADIO FREQUENCY 543-1694-002 (13499)	EA	2				*	*	*	*	*		1A4A3A3L1
P-H		COIL, RADIO FREQUENCY 543-1694-002 (13499)	EA	REF				*	*	*	*	*		1A4A3A3L2
P-H		CORE, ADJUSTABLE 56-2003-16 (92054)	EA	14				*	*	*	*	*		
P-H		CORE, ADJUSTABLE EE5117 (92054)	EA	10				*	*	*	*	*		
P-H		COIL, RADIO FREQUENCY 543-1695-002 (13499)	EA	4				*	*	*	*	*		
P-H		FORM, COIL 150-0121-000 (20254)	EA	4				*	*	*	*	*		
M-H		WIRE, ELECTRICAL 744PH (74116)	FT	REF										
X1-H		CLIP, ELECTRICAL 543-1698-002 (13499)	EA	28										
P-H		COIL, RADIO FREQUENCY 543-1696-002 (13499)	EA	5				*	*	*	*	*		1A4A3A3L3
P-H		COIL, RADIO FREQUENCY 543-1696-002 (13499)	EA	REF				*	*	*	*	*		1A4A3A3L4
P-H		COIL, RADIO FREQUENCY 543-1696-002 (13499)	EA	REF				*	*	*	*	*		1A4A3A3L5
P-H		COIL, RADIO FREQUENCY 543-1696-002 (13499)	EA	REF				*	*	*	*	*		1A4A3A3L6
P-H		COIL, RADIO FREQUENCY 543-1696-002 (13499)	EA	REF				*	*	*	*	*		1A4A3A3L7
P-H		CORE, ADJUSTABLE TUNER 56-2003-16 (92054)	EA	REF				*	*	*	*	*		
P-H		CORE, ADJUSTABLE TUNER EE5117 (92054)	EA	REF				*	*	*	*	*		
P-H		COIL, RADIO FREQUENCY 543-1697-002 (13499)	EA	10				*	*	*	*	*		
X1-H		FORM, COIL 150-0118-000 (20254)	EA	10										
X1-H		WIRE, ELECTRICAL 1544PH (74116)	FT	95										
X1-H		CLIP, ELECTRICAL COIL 543-1696-002 (13499)	EA	REF										
P-H		CAPACITOR, FIXED, MICA DIELECTRIC KCM15E181F-500WV (72136)	EA	3				*	*	*	*	*		1A4A3A3C15
P-H		CAPACITOR, FIXED, MICA DIELECTRIC KCM15E181F-500WV (72136)	EA	REF				*	*	*	*	*		1A4A3A3C16
P-H		CAPACITOR, FIXED, MICA DIELECTRIC KCM15E181F-500WV (72136)	EA	REF				*	*	*	*	*		1A4A3A3C18
P-H	5910-904-2921	CAPACITOR, FIXED, MICA DIELECTRIC SCIM15C240G (72136)	EA	3				*	*	*	*	*		1A4A3A3C6
P-H	5910-904-2921	CAPACITOR, FIXED, MICA DIELECTRIC SCIM15C240G (72136)	EA	REF				*	*	*	*	*		1A4A3A3C7
P-H	5910-904-2921	CAPACITOR, FIXED, MICA DIELECTRIC SCIM15C240G (72136)	EA	REF				*	*	*	*	*		1A4A3A3C11

SECTION III REPAIR PARTS FOR DIRECT SUPPORT, GENERAL SUPPORT, AND DEPOT MAINTENANCE (CONTINUED)

(1) SIB CODE	(2) FEDERAL STOCK NUMBER	(3) DESCRIPTION  USABLE ON CODE	(4) UNIT OF MEAS	(5) QTY INC IN UNIT	(6) 30-DAY DS MAINT ALLOWANCE			(7) 30-DAY GS MAINT ALLOWANCE			(8) 1 YR ALW PER EQUIP CNTGCT	(9) DEPOT MAINT ALW PER 100 EQUIP	(10) ILLUSTRATIONS	
					(a) 1-20	(b) 21-50	(c) 51-100	(a) 1-20	(b) 21-50	(c) 51-100			(a) FIG NO.	(b) ITEM NO. OR REFERENCE DESIGNATION
P-H		CAPACITOR, FIXED, MICA DIELECTRIC SCML5F910F (72136)	EA	2				*	*	*	*	*		1A4A3A3C12
P-H		CAPACITOR, FIXED, MICA DIELECTRIC SCML5F910F (72136)	EA	REF				*	*	*	*	*		1A4A3A3C13
P-H	5910-902-4551	CAPACITOR, FIXED, MICA DIELECTRIC SCML5F181F (72136)	EA	2				*	*	*	*	*		1A4A3A3C14
P-H	5910-902-4551	CAPACITOR, FIXED, MICA DIELECTRIC SCML5F181F (72136)	EA	REF				*	*	*	*	*		1A4A3A3C17
X2-H		BASE, PLATE 549-4407-002 (13499)	EA	2										
X1-H		BASE, PLATE 549-4406-002 (13499)	EA	2										
X2-H		BRACKET, MOUNTING 549-4413-003 (13499)	EA	2										
X1-H		TERMINAL, FEEDTHRU E1125ENTFF60 (97812)	EA	8										
X1-H		NUT, SLEEVE 549-4412-003 (13499)	EA	2										
X1-H		PLATE, SPACER 549-4405-002 (13499)	EA	2										
X1-H		NUT, SLEEVE 549-4408-002 (13499)	EA	2										
X1-H		WIRE, ELECTRICAL 00702-1324 (14018)	FT	6										
X1-H		INSULATION SLEEVING, ELECTRICAL SVHC2-20-1 (81851)	FT	2										
P-H	5915-828-9058	FILTER, BANDPASS X215-4 (81851)	EA	1				*	*	*	*	*		1A4A3A3FL
P-H	5970-832-8101	INSULATOR, DISK 548-1315-003 (13499)	EA	1				*	*	*	*	*		
P-H	5820-679-9387	AKC SPECIAL GENERATOR 544-2640-004 (13499)	EA	1				*	*	*	*	*		1A4A3A6
P-H	5999-790-0585	PRINTED CIRCUIT BOARD 544-2638-004 (13499)	EA	1				*	*	*	*	*	3-8	1A4A3A6TBI
X1-H		PRINTED CIRCUIT BOARD 544-2637-004 (13499)	EA	1				*	*	*	*	*		
P-H	5340-951-4572	RETAINER, ELECTRON TUBE 100-207-16-5 (99378)	EA	4				*	*	*	*	*		
X1-H		RIVET, TUBULAR R3484X5-32CADPL (12014)	EA	REF										
X1-H		EYELET, METALLIC A1039 HOTTINNED (57771)	EA	20										
X1-H		EYELET, METALLIC 542-0810-003 (13499)	EA	REF										
X1-H		HOLDER, TRANSISTOR 543-0111-002 (13499)	EA	10										
P-H		SPACER, SLEEVE 543-1707-002 (13499)	EA	REF				*	*	*	*	*		
X1-H		BRACKET 543-1708-002 (13499)	EA	REF										
P-H	5950-583-0982	TRANSFORMER, INTERMEDIATE FREQUENCY X068-1 (81815)	EA	1				*	*	*	*	*	3-8	1A4A3A6T1
P-H	5960-557-6126	SHIELD, ELECTRON 109-501-4 (99378)	EA	REF				*	*	*	*	*		

SECTION III REPAIR PARTS FOR DIRECT SUPPORT, GENERAL SUPPORT, AND DEPOT MAINTENANCE (CONTINUED)

(1) SIR CODE	(2) FEDERAL STOCK NUMBER	(3) DESCRIPTION  USABLE ON CODE	(4) UNIT OF MEAS	(5) QTY INC IN UNIT	(6) 30-DAY DS MAINT ALLOWANCE			(7) 30-DAY GS MAINT ALLOWANCE			(8) 1 YR ALW PER EQUIP (NTGTY)	(9) DEPOT MAINT ALW PER 100 EQUIP	(10) ILLUSTRATIONS	
					(a) 1-20	(b) 21-50	(c) 51-100	(a) 1-20	(b) 21-50	(c) 51-100			(a) FIG NO.	(b) ITEM NO. OR REFERENCE DESIGNATION
P-F		INSULATION SLEEVING, ELECTRICAL TEFTW22B (81851)	FT	REF	*	*	*	*	*	*	*			
M-H		INSULATION SLEEVING, ELECTRICAL TEFTW22-3 (81851)	FT	REF										
M-H		INSULATION SLEEVING, ELECTRICAL TEFTW22-1 (81851)	FT	REF										
M-H		INSULATION SLEEVING, ELECTRICAL TEFTW22-C (81851)	FT	REF										
XL-H		INSULATION SLEEVING, ELECTRICAL TEFTW22-6 (81851)	FT	15										
M-H		INSULATION SLEEVING, ELECTRICAL TEFTW22-5 (81851)	FT	REF										
M-H		INSULATION SLEEVING, ELECTRICAL TEFTW22-4 (81851)	FT	REF										
P-H	:5910-057-5218	CAPACITOR, FIXED, ELECTROLYTIC CL25B18CTP3 (81349)	EA	1		*	*	*	*	*	*	3-8	1A4A3A6C11	
P-H	:5910-679-9388	CAPACITOR, FIXED, ELECTROLYTIC 190D224X035A2 (56289)	EA	2		*	*	*	*	*	*	3-8	1A4A3A6C7	
P-H	:5901-679-9388	CAPACITOR, FIXED, ELECTROLYTIC 190D224X035A2 (56289)	EA	REF		*	*	*	*	*	*	3-8	1A4A3A6C13	
P-H	:5910-685-9700	CAPACITOR, FIXED, ELECTROLYTIC 190E225X035B2 (56289)	EA	1		*	*	*	*	*	*	3-8	1A4A3A6C4	
P-H	:5970-080-4704	INSULATOR, DISK 547-3839-003 (13499)	EA	10		*	*	*	*	*	*			
P-H	:5310-622-1724	NUT, SELF-LOCKING HEXAGON 68-1660-40 (72962)	EA	REF		*	*	*	*	*	*			
P-H	:5305-054-5636	SCREW, MACHINE MS51957-2 (96906)	EA	REF		*	*	*	*	*	*			
P-H	:5961-023-2701	TRANSISTOR 2N264 (07688)	EA	3		*	*	*	*	*	*	3-8	1A4A3A6Q1	
P-H	:5961-023-2701	TRANSISTOR 2N264 (07688)	EA	REF		*	*	*	*	*	*	3-8	1A4A3A6Q2	
P-H	:5961-023-2701	TRANSISTOR 2N264 (07688)	EA	REF		*	*	*	*	*	*	3-8	1A4A3A6Q3	
P-H	:5961-284-6516	SEMICONDUCTOR DEVICE, DIODE 1N198 (07688)	EA	3		*	*	*	*	*	*	3-8	1A4A3A6CR1	
P-H	:5961-284-6516	SEMICONDUCTOR DEVICE, DIODE 1N198 (07688)	EA	REF		*	*	*	*	*	*	3-8	1A4A3A6CR2	
P-H	:5961-284-6516	SEMICONDUCTOR DEVICE, DIODE 1N198 (07688)	EA	REF		*	*	*	*	*	*	3-8	1A4A3A6CR3	
M-H		WIRE, ELECTRICAL 00702-1322 (70567)	FT	REF										
M-H		CABLE, RADIO FREQUENCY RC196AU (80058)	FT	REF										
P-H	:5915-679-9390	FILTER, BANDPASS 542-3152-004 (13499)	EA	1		*	*	*	*	*	*	3-8	1A4A3A6F11	
XL-H		INSULATOR, PLATE 549-4410-002 (13499)	EA	REF										
XL-H		INSULATOR, PLATE 549-4411-002 (13499)	EA	REF										
P-H		CAPACITOR, FIXED, MICA DIELECTRIC KQML5C180G-500WV (72136)	EA	3		*	*	*	*	*	*	3-8	1A4A3A6C8	
P-H		CAPACITOR, FIXED, MICA DIELECTRIC KQML5C180G-500WV (72136)	EA	REF		*	*	*	*	*	*	3-8	1A4A3A6C9	

SECTION III REPAIR PARTS FOR DIRECT SUPPORT, GENERAL SUPPORT, AND DEPOT MAINTENANCE (CONTINUED)

(1) 308 CODE	(2) FEDERAL STOCK NUMBER	(3) DESCRIPTION  USABLE ON CODE	(4) UNIT OF MEAS	(5) QTY INC IN UNIT	(6) 30-DAY DS MAINT ALLOWANCE			(7) 30-DAY GS MAINT ALLOWANCE			(8) 1 YR ALW PER EQUIP CMTGTY	(9) DEPOT MAINT ALW PER 100 EQUIP	(a) FIG NO.	(b) ITEM NO. OR REFERENCE DESIGNATION
					(a) 1-20	(b) 21-50	(c) 51-100	(a) 1-20	(b) 21-50	(c) 51-100				
P-H		CAPACITOR, FIXED, MICA DIELECTRIC KCM15C180G-500WV (72136)	EA	REF				*	*	*	*	*	3-8	1A4A3A6C10
X1-H		SPACER, COIL 554-0672-002 (13499)	EA	REF										
X2-H		CASE, FILTER 549-4414-003 (13499)	EA	1										
M-H		WIRE, ELECTRICAL 00702-132 (70967)	FT	REF										
P-H		COIL, RADIC FREQUENCY 543-1694-002 (13499)	EA	2				*	*	*	*	*		1A4A3A6L1
P-H		COIL, RADIO FREQUENCY 543-1694-002 (13499)	EA	REF				*	*	*	*	*		1A4A3A6L2
P-H		CORE, ADJUSTABLE TUNER 56-2003-16 (92054)	EA	REF				*	*	*	*	*		
P-H		CORE, ADJUSTABLE TUNER EE5117 (92054)	EA	REF				*	*	*	*	*		
P-H		COIL, RADIO FREQUENCY 543-1695-002 (13499)	EA	REF				*	*	*	*	*		
P-H		FORM, COIL 15C-CL21-000 (20254)	EA	REF				*	*	*	*	*		
M-H		WIRE, ELECTRICAL 744PN (74116)	FT	REF										
X1-H		CLIP, ELECTRICAL COIL 543-1698-002 (13499)	EA	REF										
P-H		COIL, RADIO FREQUENCY 543-1696-002 (13499)	EA	5				*	*	*	*	*		1A4A3A6L3
P-H		COIL, RADIO FREQUENCY 543-1696-002 (13499)	EA	REF				*	*	*	*	*		1A4A3A6L4
P-H		COIL, RADIO FREQUENCY 543-1696-002 (13499)	EA	REF				*	*	*	*	*		1A4A3A6L5
P-H		COIL, RADIO FREQUENCY 543-1696-002 (13499)	EA	REF				*	*	*	*	*		1A4A3A6L6
P-H		COIL, RADIO FREQUENCY 543-1696-002 (13499)	EA	REF				*	*	*	*	*		1A4A3A6L7
P-H		CORE, ADJUSTABLE TUNER 56-2003-16 (92054)	EA	REF				*	*	*	*	*		
P-H		CORE, ADJUSTABLE TUNER EE5117 (92054)	EA	REF				*	*	*	*	*		
P-H		COIL, RADIO FREQUENCY 543-1697-002 (13499)	EA	REF				*	*	*	*	*		
X1-H		FORM, COIL 15C-CL18-000 (20254)	EA	REF										
X1-H		WIRE, ELECTRICAL 1544PN (74116)	FT	REF										
X1-H		CLIP, ELECTRICAL COIL 543-1698-002 (13499)	EA	REF										
P-H		CAPACITOR, FIXED, MICA DIELECTRIC KCM15E181F-500WV (72136)	EA	3				*	*	*	*	*		1A4A3A6C15
P-H		CAPACITOR, FIXED, MICA DIELECTRIC KCM15E181F-500WV (72136)	EA	REF				*	*	*	*	*		1A4A3A6C16
P-H		CAPACITOR, FIXED, MICA DIELECTRIC KCM15E181F-500WV (72136)	EA	REF				*	*	*	*	*		1A4A3A6C18
P-H		CAPACITOR, FIXED, MICA DIELECTRIC SCM15C180G (72136)	EA	3				*	*	*	*	*	3-8	1A4A3A6C6

SECTION III REPAIR PARTS FOR DIRECT SUPPORT, GENERAL SUPPORT, AND DEPOT MAINTENANCE (CONTINUED)

(1) SNR CODE	(2) FEDERAL STOCK NUMBER	(3) DESCRIPTION  USABLE ON CODE	(4) UNIT OF MEAS	(5) QTY INC IN UNIT	(6) 30-DAY DS MAINT ALLOWANCE			(7) 30-DAY GS MAINT ALLOWANCE			(8) 1 YR ALW PER EQUIP CNTGCT	(9) DEPOT MAINT ALW PER 100 EQUIP	(10) ILLUSTRATIONS	
					(a)	(b)	(c)	(a)	(b)	(c)			(a)	(b)
					1-20	21-50	51-100	1-20	21-50	51-100			FIG NO.	ITEM NO. OR REFERENCE DESIGNATION
P-H		CAPACITOR, FIXED, MICA DIELECTRIC SCM15C180G (72136)	EA	REF				*	*	*	*	*	3-8	1A4A3A6C7
P-H		CAPACITOR, FIXED, MICA DIELECTRIC SCM15C180G (72136)	EA	REF				*	*	*	*	*	3-8	1A4A3A6C11
P-H		CAPACITOR, FIXED, MICA DIELECTRIC SCM15F910F (72136)	EA	2				*	*	*	*	*		1A4A3A6C12
P-H		CAPACITOR, FIXED, MICA DIELECTRIC SCM15F910F (72136)	EA	REF				*	*	*	*	*	3-8	1A4A3A6C13
P-H	5910-902-4551	CAPACITOR, FIXED, MICA DIELECTRIC SCM15F181F (72136)	EA	2				*	*	*	*	*	3-8	1A4A3A6C14
P-H	5910-902-4551	CAPACITOR, FIXED, MICA DIELECTRIC SCM15F181F (72136)	EA	REF				*	*	*	*	*		1A4A3A6C17
X2-H		BASE, PLATE, FILTER 549-4407-002 (13499)	EA	REF										
X2-H		BASE, PLATE, FILTER 549-4406-002 (13499)	EA	REF										
X2-H		BRACKET, MOUNTING 549-4413-003 (13499)	EA	REF										
X1-H		TERMINAL, FEEDTHRU R1245SNTFP60 (97814)	EA	REF										
P-H		SPACER, SLEEVE 549-4409-002 (13499)	EA	2				*	*	*	*	*		
X1-H		WIRE, ELECTRICAL 00702-1324 (14018)	FT	REF										
X1-H		INSULATION SLEEVING, ELECTRICAL SVHC2-20-1 (81851)	FT	REF										
P-H	5905-942-9326	RESISTOR, FIXED, COMPOSITION RC20GF561K (81349)	EA	1				*	*	*	*	*	3-8	1A4A3A6R18
P-F	5905-195-6806	RESISTOR, FIXED, COMPOSITION RC20GF102K (81349)	EA	1	*	*	*	*	*	*	*	*	3-8	1A4A3A6R20
P-F	5905-171-2009	RESISTOR, FIXED, COMPOSITION RC20GF222K (81349)	EA	1	*	*	*	*	*	*	*	*	3-8	1A4A3A6R11
P-F	5905-185-8518	RESISTOR, FIXED, COMPOSITION RC20GF103K (81349)	EA	3	*	*	*	*	*	*	*	*	3-8	1A4A3A6R10
P-F	5905-185-8518	RESISTOR, FIXED, COMPOSITION RC20GF103K (81349)	EA	REF	*	*	*	*	*	*	*	*	3-8	1A4A3A6R15
P-F	5905-185-8518	RESISTOR, FIXED, COMPOSITION RC20GF103K (81349)	EA	REF	*	*	*	*	*	*	*	*	3-8	1A4A3A6R16
P-F	5905-141-0591	RESISTOR, FIXED, COMPOSITION RC20GF153J (81349)	EA	1	*	*	*	*	*	*	*	*	3-8	1A4A3A6R14
P-H	5905-106-1282	RESISTOR, FIXED, COMPOSITION RC20GF223K (81349)	EA	2				*	*	*	*	*	3-8	1A4A3A6R12
P-H	5905-106-1282	RESISTOR, FIXED, COMPOSITION RC20GF223K (81349)	EA	REF				*	*	*	*	*	3-8	1A4A3A6R17
P-H	5905-171-1986	RESISTOR, FIXED, COMPOSITION RC20GF563J (81349)	EA	1				*	*	*	*	*	3-8	1A4A3A6R4
P-H	5905-110-0993	RESISTOR, FIXED, COMPOSITION RC20GF123K (81349)	EA	1				*	*	*	*	*	3-8	1A4A3A6R5
P-H	5905-192-3987	RESISTOR, FIXED, COMPOSITION RC20GF104K (81349)	EA	1				*	*	*	*	*	3-8	1A4A3A6R3
P-F	5905-245-0023	RESISTOR, FIXED, COMPOSITION RC20GF682K (81349)	EA	1	*	*	*	*	*	*	*	*		1A4A3A6R7
P-H	5905-256-0387	RESISTOR, FIXED, COMPOSITION RC20GF681K (81349)	EA	1				*	*	*	*	*	3-8	1A4A3A6R13



SECTION III REPAIR PARTS FOR DIRECT SUPPORT, GENERAL SUPPORT, AND DEPOT MAINTENANCE (CONTINUED)

(1) SIC CODE	(2) FEDERAL STOCK NUMBER	(3) DESCRIPTION  USABLE ON CODE	(4) UNIT OF MEAS	(5) QTY INC IN UNIT	(6) 30-DAY DS MAINT ALLOWANCE			(7) 30-DAY GS MAINT ALLOWANCE			(8) 1 YR ALM PER EQUIP (NTGCY)	(9) DEPOT MAINT ALW PER 100 EQUIP	(10) ILLUSTRATIONS	
					(a)	(b)	(c)	(a)	(b)	(c)			(a) FIG NO.	(b) ITEM NO. OR REFERENCE DESIGNATION
					1-20	21-50	51-100	1-20	21-50	51-100				
P-H	5960-230-5226	ELECTRON TUBE 5636 (82219)	EA	1				*	*	*	*	*	3-8	1A4A3A6V1
P-H	5905-249-4248	RESISTOR, FIXED, COMPOSITION RC20GF124K (81349)	EA	1				*	*	*	*	*	3-8	1A4A3A6R8
P-H	5910-663-5850	CAPACITOR, FIXED, MICA DIELECTRIC 22H5T27EG (14655)	EA	3				*	*	*	*	*	3-8	1A4A3A6C5
P-H	5910-663-5850	CAPACITOR, FIXED, MICA DIELECTRIC 22H5T27EG (14655)	EA	REF				*	*	*	*	*		1A4A3A6C8
P-H	5910-663-5850	CAPACITOR, FIXED, MICA DIELECTRIC 22H5T27EG (14655)	EA	REF				*	*	*	*	*		1A4A3A6C9
P-H	5910-728-1577	CAPACITOR, FIXED, MICA DIELECTRIC 22H5T27EG (14655)	EA	1				*	*	*	*	*	3-8	1A4A3A6C6
P-H	5910-577-1414	CAPACITOR, FIXED, PAPER DIELECTRIC 186P47203S3 (56289)	EA	1				*	*	*	*	*	3-8	1A4A3A6C1
P-F	5910-060-9019	CAPACITOR, FIXED, MICA DIELECTRIC 22H5T51EG (14655)	EA	1	*	*	*	*	*	*	*	*	3-8	1A4A3A6C10
P-F	5910-688-8701	CAPACITOR, FIXED, PAPER DIELECTRIC 186P68302S3 (56289)	EA	1	*	*	*	*	*	*	*	*	3-8	1A4A3A6C14
P-H	5910-726-0474	CAPACITOR, FIXED, MICA DIELECTRIC 22H5T37EG (14655)	EA	1				*	*	*	*	*	3-8	1A4A3A6C3
P-H	5820-771-0952	AMPLIFIER, INTERMEDIATE FREQUENCY 544-2634-004 (13499)	EA	1				*	*	*	*	*	3-9	1A4A3A7
P-H	5950-615-9619	COIL, RADIO FREQUENCY X062-1 (81815)	EA	1				*	*	*	*	*	3-9	1A4A3A7L1
P-H	5950-615-5029	TRANSFORMER, INTERMEDIATE FREQUENCY X065-1 (81815)	EA	1				*	*	*	*	*	3-9	1A4A3A7T1
P-H	5950-615-0595	TRANSFORMER, INTERMEDIATE FREQUENCY X066 (81815)	EA	1				*	*	*	*	*	3-9	1A4A3A7L2
P-H	5950-651-5323	TRANSFORMER, INTERMEDIATE FREQUENCY X077-1 (81815)	EA	1				*	*	*	*	*	3-9	1A4A3A7T2
P-H	5910-936-1522	CAPACITOR, FIXED, ELECTROLYTIC 150D106X0020B2 (56289)	EA	3				*	*	*	*	*	3-9	1A4A3A7C7
P-H	5910-936-1522	CAPACITOR, FIXED, ELECTROLYTIC 150D106X0020B2 (56289)	EA	REF				*	*	*	*	*		1A4A3A7C12
P-H	5910-936-1522	CAPACITOR, FIXED, ELECTROLYTIC 150D106X0020B2 (56289)	EA	REF				*	*	*	*	*	3-9	1A4A3A7C13
P-H	5961-023-2701	TRANSISTOR 2N264 (07688)	EA	3				*	*	*	*	*	3-9	1A4A3A7Q1
P-H	5961-023-2701	TRANSISTOR 2N264 (07688)	EA	REF				*	*	*	*	*	3-9	1A4A3A7Q2
P-H	5961-023-2701	TRANSISTOR 2N264 (07688)	EA	REF				*	*	*	*	*	3-9	1A4A3A7Q3
P-H	5961-556-2091	SEMICONDUCTOR DEVICE, DIODE 1N270 (07688)	EA	1				*	*	*	*	*		1A4A3A7CR2
M-H		WIRE, ELECTRICAL 00702-1322 (70567)	FT	REF										
M-H		CABLE, RADIO FREQUENCY RG196AU (80058)	FT	REF										
P-H	5915-583-1963	FILTER, BANDPASS 526-9309-000 (13499)	EA	1				*	*	*	*	*	3-9	1A4A3A7F11
P-H	5999-790-0590	PRINTED CIRCUIT BOARD 543-1778-003 (13499)	EA	1				*	*	*	*	*	3-9	1A4A3A7B1
XI-H		RIVET, TUBULAR R3484X1-8CADPL (12014)	EA	REF										

SECTION III REPAIR PARTS FOR DIRECT SUPPORT, GENERAL SUPPORT, AND DEPOT MAINTENANCE (CONTINUED)

(1) SR CODE	(2) FEDERAL STOCK NUMBER	(3) DESCRIPTION  USABLE ON CODE	(4) UNIT OF MEAS	(5) QTY INC IN UNIT	(6) 30-DAY GS MAINT ALLOWANCE			(7) 30-DAY GS MAINT ALLOWANCE			(8) 1 YR ALW PER EQUIP CNTGCTY	(9) DEPOT MAINT ALW PER 100 EQUIP	(10) ILLUSTRATIONS	
					(a) 1-20	(b) 21-50	(c) 51-100	(a) 1-20	(b) 21-50	(c) 51-100			(a) FIG NO.	(b) ITEM NO. OR REFERENCE DESIGNATION
X2-H	5325-073-1172	EYELET, METALLIC SE25CADPL (90030)	EA	48										
X1-H		EYELET, METALLIC A1039 HOTTINNED (57771)	EA	REF										
P-H	5340-893-5494	CLIP, SPRING TENSION 100-300-16-13 (99378)	EA	REF				*	*	*	*	*		
X1-H		EYELET, METALLIC 542-0810-003 (13499)	EA	REF										
X1-H		PRINTED CIRCUIT BOARD 542-4133-004 (13499)	EA	1										
P-F	5935-615-8555	JACK, TIP SKT5BCWHT (98291)	EA	2	*	*	*	*	*	*	*	*	3-9	1A4A3A7J1
P-F	5935-615-8555	JACK, TIP SKT5BCWHT (98291)	EA	REF	*	*	*	*	*	*	*	*	3-9	1A4A3A7J2
X2-H		BRACKET, TEST 543-1711-002 (13499)	EA	2										
X1-H		HOLDER, TRANSISTOR 543-0111-002 (13499)	EA	REF										
P-H		SPACER, SLEEVE 543-1622-002 (13499)	EA	5				*	*	*	*	*		
P-H		SPACER, RETAINER 543-1623-002 (13499)	EA	5				*	*	*	*	*		
P-H		POST, SPACING 543-1624-002 (13499)	EA	1				*	*	*	*	*		
P-H	5905-752-3335	RESISTOR, FIXED, COMPOSITION RC07GF122K (81349)	EA	1				*	*	*	*	*	3-9	1A4A3A7R4
P-H	5905-114-5343	RESISTOR, FIXED, COMPOSITION RC07GF182K (81349)	EA	1				*	*	*	*	*	3-9	1A4A3A7R6
P-H	5905-816-8554	RESISTOR, FIXED, COMPOSITION RC07GF103K (81349)	EA	1				*	*	*	*	*	3-9	1A4A3A7R7
P-H	5905-252-5428	RESISTOR, FIXED, COMPOSITION RC20GF680K (81349)	EA	1				*	*	*	*	*	3-9	1A4A3A7R3
P-H	5905-256-0409	RESISTOR, FIXED, COMPOSITION RC20GF221K (81349)	EA	1				*	*	*	*	*	3-9	1A4A3A7R1
P-H	5905-195-6543	RESISTOR, FIXED, COMPOSITION RC20GF962K (81349)	EA	1				*	*	*	*	*	3-9	1A4A3A7R8
P-F	5905-106-1273	RESISTOR, FIXED, COMPOSITION RC20GF153J (81349)	EA	1	*	*	*	*	*	*	*	*	3-9	1A4A3A7R14
P-H	5905-190-8879	RESISTOR, FIXED, COMPOSITION RC20GF183K (81349)	EA	1				*	*	*	*	*	3-9	1A4A3A7R2
P-H	5905-114-5416	RESISTOR, FIXED, COMPOSITION RC20GF274K (81349)	EA	1				*	*	*	*	*	3-9	1A4A3A7R12
P-H	5905-088-3101	RESISTOR, FIXED, FILM RN65D2870F (81349)	EA	1				*	*	*	*	*	3-9	1A4A3A7R11
P-H	5905-892-7283	RESISTOR, FIXED, FILM RN65D7501F (81349)	EA	1				*	*	*	*	*	3-9	1A4A3A7R5
P-H	5910-932-2738	CAPACITOR, FIXED, MICA DIELECTRIC 22H5Q82EG (14655)	EA	1				*	*	*	*	*	3-9	1A4A3A7C1
P-H	5910-681-7140	CAPACITOR, FIXED, MICA DIELECTRIC 22H5T18EG (14655)	EA	1				*	*	*	*	*	3-9	1A4A3A7C2
P-H	5910-725-1993	CAPACITOR, FIXED, MICA DIELECTRIC 22H5T2EG (14655)	EA	3				*	*	*	*	*	3-9	1A4A3A7C5
P-H	5910-725-1993	CAPACITOR, FIXED, MICA DIELECTRIC 22H5T2EG (14655)	EA	REF				*	*	*	*	*	3-9	1A4A3A7C10

SECTION III REPAIR PARTS FOR DIRECT SUPPORT, GENERAL SUPPORT, AND DEPOT MAINTENANCE (CONTINUED)

(1) SRR CODE	(2) FEDERAL STOCK NUMBER	(3) DESCRIPTION  REFERENCE NUMBER & MFR. CODE	(4) UNIT OF MEAS	(5) QTY INC IN UNIT	(6) 30-DAY DS MAINT ALLOWANCE			(7) 30-DAY GS MAINT ALLOWANCE			(8) 1 YR ALW PER EQUIP CNTGTY	(9) DEPOT MAINT ALW PER 100 EQUIP	(10) ILLUSTRATIONS	
					(a) 1-20	(b) 21-50	(c) 51-100	(a) 1-20	(b) 21-50	(c) 51-100			(a) FIG NO.	(b) ITEM NO. OR REFERENCE DESIGNATION
P-H	5910-725-1993	CAPACITOR, FIXED, MICA DIELECTRIC 22H5T2BG (14655)	EA	REF				*	*	*	*	*	3-9	1A4A3A7C14
P-F	5910-060-9619	CAPACITOR, FIXED, MICA DIELECTRIC 22H5T51EG (14655)	EA	1	*	*	*	*	*	*	*	*	3-9	1A4A3A7C3
P-H	5970-080-4705	INSULATOR, DISK 546-6076-002 (13499)	EA	3				*	*	*	*	*		
P-H	5970-080-4704	INSULATOR, DISK 547-3839-003 (13499)	EA	REF				*	*	*	*	*		
X1-H		INSULATION SLEEVING, ELECTRICAL TEFTW22-6 (81851)	FT	REF										
M-H		INSULATION SLEEVING, ELECTRICAL TEFTW22-5 (81851)	FT	REF										
M-H		INSULATION SLEEVING, ELECTRICAL TEFTW22-4 (81851)	FT	REF										
P-H	5961-866-0476	SEMICONDUCTOR DEVICE, DIODE 1N457 (07688)	EA	1				*	*	*	*	*	3-9	1A4A3A7CR1
M-H		BUMPER, RUBBER 543-1715-002 (13499)	EA	6										
P-F	5305-764-2966	SCREW, MACHINE MS51959-2 (96906)	EA	REF	*	*	*	*	*	*	*	*		
P-H	5910-686-6929	CAPACITOR, FIXED, PAPER DIELECTRIC 118F33302S3 (56289)	EA	6				*	*	*	*	*	3-9	1A4A3A7C6
P-H	5910-686-6929	CAPACITOR, FIXED, PAPER DIELECTRIC 118F33302S3 (56289)	EA	REF				*	*	*	*	*	3-9	1A4A3A7C8
P-H	5910-686-6929	CAPACITOR, FIXED, PAPER DIELECTRIC 118F33302S3 (56289)	EA	REF				*	*	*	*	*	3-9	1A4A3A7C9
P-H	5910-686-6929	CAPACITOR, FIXED, PAPER DIELECTRIC 118F33302S3 (56289)	EA	REF				*	*	*	*	*	3-9	1A4A3A7C11
P-H	5910-686-6929	CAPACITOR, FIXED, PAPER DIELECTRIC 118F33302S3 (56289)	EA	REF				*	*	*	*	*	3-9	1A4A3A7C13
P-H	5910-686-6929	CAPACITOR, FIXED, PAPER DIELECTRIC 118F33302S3 (56289)	EA	REF				*	*	*	*	*	3-9	1A4A3A7C16
P-F	5910-141-0591	RESISTOR, FIXED, COMPOSITION RC20GF103K (81349)	EA	1	*	*	*	*	*	*	*	*	3-9	1A4A3A7R9
P-H	5905-171-1998	RESISTOR, FIXED, COMPOSITION RC20GF333K (81349)	EA	1				*	*	*	*	*	3-9	1A4A3A7R13
P-F	5905-245-0023	RESISTOR, FIXED, COMPOSITION RC20GF682K (81349)	EA	1	*	*	*	*	*	*	*	*	3-9	1A4A3A7R15
P-H	5905-195-6453	RESISTOR, FIXED, COMPOSITION RC20GF562J (81349)	EA	1				*	*	*	*	*	3-9	1A4A3A7R10
P-H	5820-444-8787	OSCILLATOR 545-5866-005 (13499)	EA	1				*	*	*	*	*		1A4A3A2
P-H	5970-080-4704	INSULATOR, DISK 547-3839-003 (13499)	EA	REF				*	*	*	*	*		
P-H	5970-080-4705	INSULATOR, DISK 546-6076-002 (13499)	EA	REF				*	*	*	*	*		
P-H	5820-868-1283	PRINTED CIRCUIT BOARD 545-5865-005 (13499)	EA	1				*	*	*	*	*		1A4A3A2T81
X1-H		PRINTED CIRCUIT BOARD 545-5864-005 (13499)	EA	1										
P-R		TERMINAL, STUD 542-4085-002 (13499)	EA	REF				*	*	*	*	*		
X2-H	5325-073-1172	EYELET, METALLIC SE25CADPL (90030)	EA	REF										

SECTION III REPAIR PARTS FOR DIRECT SUPPORT, GENERAL SUPPORT, AND DEPOT MAINTENANCE (CONTINUED)

(1) SR CODE	(2) FEDERAL STOCK NUMBER	(3) DESCRIPTION  USABLE ON CODE	(4) UNIT OF MEAS	(5) QTY INC IN UNIT	(6) 30-DAY DS MAINT ALLOWANCE			(7) 30-DAY GS MAINT ALLOWANCE			(8) 1 YR ALW PER EQUIP CHRGY	(9) DEPOT MAINT ALW PER 100 EQUIP	(10) ILLUSTRATIONS	
					(a) 1-20	(b) 21-50	(c) 51-100	(a) 1-20	(b) 21-50	(c) 51-100			(a) FIG NO.	(b) ITEM NO. OR REFERENCE DESIGNATION
X1-H		EYELET, METALLIC A1039 HOTTINNED (57771)	EA	REF										
P-F	5935-615-8555	JACK, TIP SKT5BCWHT (98291)	EA	2	*	*	*	*	*	*	*	3-10	1A4A3A2J1	
P-F	5935-615-8555	JACK, TIP SKT5BCWHT (98291)	EA	REF	*	*	*	*	*	*	*	3-10	1A4A3A2J2	
X1-H		EYELET, METALLIC 542-0810-003 (13499)	EA	REF										
X2-H		BRACKET, TEST 543-1693-002 (13499)	EA	1										
X1-H		HOLDER, TRANSISTOR 543-0111-002 (13499)	EA	REF										
P-F		TERMINAL, STUD 545-3205-002 (13499)	EA	REF	*	*	*	*	*	*	*			
X2-H		EYELET, METALLIC 542-0811-003 (13499)	EA	6G										
X2-H		BRACKET, ANGLE 545-6167-002 (13499)	EA	1										
P-H		TERMINAL, STUD 542-4091-002 (13499)	EA	5				*	*	*	*			
P-H		TERMINAL, LUG 542-4094-002 (13499)	EA	3L				*	*	*	*			
P-H	5950-474-5716	TRANSFORMER, INTERMEDIATE FREQUENCY 278-0296-000 (54753)	EA	1				*	*	*	*	3-10	1A4A3A2T1	
P-H	5950-474-6346	TRANSFORMER, INTERMEDIATE FREQUENCY 278-0297-000 (54753)	EA	1				*	*	*	*	3-10	1A4A3A2T4	
P-H	5950-044-5027	TRANSFORMER, INTERMEDIATE FREQUENCY X075-1 (81815)	EA	2				*	*	*	*	3-10	1A4A3A2T2	
P-H	5950-044-5027	TRANSFORMER, INTERMEDIATE FREQUENCY X075-1 (81815)	EA	REF				*	*	*	*	3-10	1A4A3A2T3	
P-H	5910-936-1522	CAPACITOR, FIXED, ELECTROLYTIC 150D106X0020B2 (56289)	EA	2				*	*	*	*	3-10	1A4A3A2C8	
P-H	5910-936-1522	CAPACITOR, FIXED, ELECTROLYTIC 150D106X0020B2 (56289)	EA	REF				*	*	*	*	3-10	1A4A3A2C10	
P-H	5910-849-7257	CAPACITOR, FIXED, PAPER DIELECTRIC 118P6840254 (56289)	EA	1				*	*	*	*	3-10	1A4A3A2C8	
P-H	5950-444-8793	COIL, RADIO FREQUENCY 0298-000 (54753)	EA	2				*	*	*	*	3-10	1A4A3A2L1	
P-H	5950-444-8793	COIL, RADIO FREQUENCY 0298-000 (54753)	EA	REF				*	*	*	*	3-10	1A4A3A2L2	
P-H	5950-615-0595	TRANSFORMER, INTERMEDIATE FREQUENCY X066 (81815)	EA	1				*	*	*	*	3-10	1A4A3A2L3	
P-H	5950-615-9619	COIL, RADIO FREQUENCY X062-1 (81815)	EA	1				*	*	*	*	3-10	1A4A3A2L4	
P-H	5961-556-2091	SEMICONDUCTOR DEVICE, DIODE 1N270 (07688)	EA	4				*	*	*	*	3-10	1A4A3A2CR1	
P-H	5961-556-2091	SEMICONDUCTOR DEVICE, DIODE 1N270 (07688)	EA	REF				*	*	*	*	3-10	1A4A3A2CR2	
P-H	5961-556-2091	SEMICONDUCTOR DEVICE, DIODE 1N270 (07688)	EA	REF				*	*	*	*	3-10	1A4A3A2CR5	
P-H	5961-556-2091	SEMICONDUCTOR DEVICE, DIODE 1N270 (07688)	EA	REF				*	*	*	*	3-10	1A4A3A2CR6	
P-H	5961-866-0476	SEMICONDUCTOR DEVICE, DIODE 1N457 (07688)	EA	2				*	*	*	*	3-10	1A4A3A2CR3	

SECTION III REPAIR PARTS FOR DIRECT SUPPORT, GENERAL SUPPORT, AND DEPOT MAINTENANCE (CONTINUED)

(1) SRR CODE	(2) FEDERAL STOCK NUMBER	(3) DESCRIPTION  USABLE OR CODE	(4) UNIT OF MEAS	(5) QTY INC IN UNIT	(6) 30-DAY DS MAINT ALLOWANCE			(7) 30-DAY GS MAINT ALLOWANCE			(8) 1 YR ALM PER EQUIP CMTG/CY	(9) DEPOT MAINT ALM PER 100 EQUIP	(10) ILLUSTRATIONS	
					(a) 1-20	(b) 21-50	(c) 51-100	(a) 1-20	(b) 21-50	(c) 51-100			(a) FIG NO.	(b) ITEM NO. OR REFERENCE DESIGNATION
P-H	5961-866-0476	SEMICONDUCTOR DEVICE, DIODE 1N457 (07688)	EA	REF				*	*	*	*	*	3-10	1A4A3A2CR4
P-H	5961-023-2701	TRANSISTOR 2N264 (07688)	EA	4				*	*	*	*	*	3-10	1A4A3A2Q3
P-H	5961-023-2701	TRANSISTOR 2N265 (07688)	EA	REF				*	*	*	*	*	3-10	1A4A3A2Q4
P-H	5961-023-2701	TRANSISTOR 2N265 (07688)	EA	REF				*	*	*	*	*	3-10	1A4A3A2Q5
P-H	5961-023-2701	TRANSISTOR 2N265 (07688)	EA	REF				*	*	*	*	*	3-10	1A4A3A2Q6
P-H	5905-993-2263	RESISTOR, FIXED, FILM RM65D4221F (81349)	EA	1				*	*	*	*	*		1A4A3A2R7
P-H	5905-993-2268	RESISTOR, FIXED, FILM RM65D2152F (81349)	EA	2				*	*	*	*	*	3-10	1A4A3A2R28
P-H	5905-993-2268	RESISTOR, FIXED, FILM RM65D2152F (81349)	EA	REF				*	*	*	*	*	3-10	1A4A3A2R29
P-H	5905-993-6341	RESISTOR, FIXED, FILM RM65D7500F (81349)	EA	1				*	*	*	*	*	3-10	1A4A3A2R11
P-H	5905-195-6453	RESISTOR, FIXED, COMPOSITION RC20GF562K (81349)	EA	3				*	*	*	*	*	3-10	1A4A3A2R8
P-H	5905-195-6453	RESISTOR, FIXED, COMPOSITION RC20GF562K (81349)	EA	REF				*	*	*	*	*	3-10	1A4A3A2R12
P-H	5905-195-6453	RESISTOR, FIXED, COMPOSITION RC20GF562K (81349)	EA	REF				*	*	*	*	*	3-10	1A4A3A2R18
P-H	5905-245-0023	RESISTOR, FIXED, COMPOSITION RC20GF682K (81349)	EA	1				*	*	*	*	*	3-10	1A4A3A2R15
P-H	5905-257-2631	RESISTOR, FIXED, COMPOSITION RC20GF821K (81349)	EA	2				*	*	*	*	*	3-10	1A4A3A2R10
P-H	5905-257-2631	RESISTOR, FIXED, COMPOSITION RC20GF821K (81349)	EA	REF				*	*	*	*	*	3-10	1A4A3A2R31
P-H	5905-190-8879	RESISTOR, FIXED, COMPOSITION RC20GF183K (81349)	EA	3				*	*	*	*	*	3-10	1A4A3A2R13
P-H	5905-190-8879	RESISTOR, FIXED, COMPOSITION RC20GF183K (81349)	EA	REF				*	*	*	*	*	3-10	1A4A3A2R16
P-H	5905-190-8879	RESISTOR, FIXED, COMPOSITION RC20GF183K (81349)	EA	REF				*	*	*	*	*	3-10	1A4A3A2R21
P-F	5905-141-0591	RESISTOR, FIXED, COMPOSITION RC20GF103K (81349)	EA	1	*	*	*	*	*	*	*	*	3-10	1A4A3A2R7
P-H	5905-256-0409	RESISTOR, FIXED, COMPOSITION RC20GF221K (81349)	EA	2				*	*	*	*	*	3-10	1A4A3A2R14
P-H	5905-256-0409	RESISTOR, FIXED, COMPOSITION RC20GF221K (81349)	EA	REF				*	*	*	*	*	3-10	1A4A3A2R17
P-H	5905-252-5428	RESISTOR, FIXED, COMPOSITION RC20GF680K (81349)	EA	1				*	*	*	*	*	3-10	1A4A3A2R19
P-H	5905-061-2120	RESISTOR, FIXED, FILM RM65D4640F (81349)	EA	1				*	*	*	*	*	3-10	1A4A3A2R4
P-H	5905-254-9201	RESISTOR, FIXED, COMPOSITION RC20GF473J (81349)	EA	4				*	*	*	*	*	3-10	1A4A3A2R25
P-H	5905-254-9201	RESISTOR, FIXED, COMPOSITION RC20GF473J (81349)	EA	REF				*	*	*	*	*	3-10	1A4A3A2R26
P-H	5905-104-5755	RESISTOR, SELECT FROM RESISTOR, FIXED, COMPOSITION RC20GF100J (81349)	EA	1				*	*	*	*	*	3-10	1A4A3A2R24
P-H	5905-251-7757	-OR- RESISTOR, FIXED, COMPOSITION RC20GF270K (81349) -OR-	EA	1				*	*	*	*	*	3-10	1A4A3A2R24

SECTION III REPAIR PARTS FOR DIRECT SUPPORT, GENERAL SUPPORT, AND DEPOT MAINTENANCE (CONTINUED)

(1) SNR CODE	(2) FEDERAL STOCK NUMBER	(3) DESCRIPTION  USABLE ON CODE	(4) UNIT OF MEAS	(5) QTY INC IN UNIT	(6) 30-DAY DS MAINT ALLOWANCE			(7) 30-DAY GS MAINT ALLOWANCE			(8) 1 YR ALW PER EQUIP CNTGCT	(9) DEPOT MAINT ALW PER 100 EQUIP	(10) ILLUSTRATIONS	
					(a) 1-20	(b) 21-50	(c) 51-100	(a) 1-20	(b) 21-50	(c) 51-100			(a) FIG NO.	(b) ITEM NO. OR REFERENCE DESIGNATION
P-H	5905-141-1118	RESISTOR, FIXED, COMPOSITION RC20GF39CK (81349) -OR-	EA	1				*	*	*	*	*	3-10	1A4A3A2R24
P-H	5905-171-2002	RESISTOR, FIXED, COMPOSITION RC20GF47CK (81349) -OR-	EA	1				*	*	*	*	*	3-10	1A4A3A2R24
P-H	5905-252-5428	RESISTOR, FIXED, COMPOSITION RC20GF68CK (81349) -OR-	EA	1				*	*	*	*	*	3-10	1A4A3A2R24
P-H	59005-106-9344	RESISTOR, FIXED, COMPOSITION RC20GF101J (81349) -OR-	EA	1				*	*	*	*	*	3-10	1A4A3A2R24
P-H	5905-279-2658	RESISTOR, FIXED, COMPOSITION RC20GF82CK (81349) -OR-	EA	1				*	*	*	*	*	3-10	1A4A3A2R24
P-H	5905-279-1898	RESISTOR, FIXED, COMPOSITION RC20GF56CK (81349)	EA	1				*	*	*	*	*	3-1G	1A4A3A2R24
P-H	5905-192-0662	RESISTOR, FIXED, COMPOSITION RC20GF184K (81349)	EA	1				*	*	*	*	*	3-10	1A4A3A2R26
P-H	5905-192-3987	RESISTOR, FIXED, COMPOSITION RC20GF104K (81349)	EA	1				*	*	*	*	*	3-10	1A4A3A2R27
P-H	5905-254-9201	RESISTOR, FIXED, COMPOSITION RC20GF473J (81349)	EA	REF				*	*	*	*	*	3-10	1A4A3A2R25
P-H	5905-254-9201	RESISTOR, FIXED, COMPOSITION RC20GF473J (81349)	EA	REF				*	*	*	*	*	3-10	1A4A3A2R26
P-H	5910-725-1993	CAPACITOR, FIXED, MICA DIELECTRIC 22H5T2EG (14655)	EA	3				*	*	*	*	*	3-10	1A4A3A2C13
P-H	5910-725-1993	CAPACITOR, FIXED, MICA DIELECTRIC 22H5T2EG (14655)	EA	REF				*	*	*	*	*	3-10	1A4A3A2C16
P-H	5910-725-1993	CAPACITOR, FIXED, MICA DIELECTRIC 22H5T2EG (14655)	EA	REF				*	*	*	*	*	3-10	1A4A3A2C20
P-H	5910-836-0412	CAPACITOR, FIXED, MICA DIELECTRIC DM20F202F500WV (72136)	EA	3				*	*	*	*	*	3-10	1A4A3A2C5
P-H	5910-836-0412	CAPACITOR, FIXED, MICA DIELECTRIC DM20F202F500WV (72136)	EA	REF				*	*	*	*	*	3-10	1A4A3A2C6
P-H	5910-836-0412	CAPACITOR, FIXED, MICA DIELECTRIC DM20F202F500WV (72136)	EA	REF				*	*	*	*	*	3-10	1A4A3A2C37
P-H	5910-060-9619	CAPACITOR, FIXED, MICA DIELECTRIC 22H5T51EJ (14655)	EA	1				*	*	*	*	*	3-10	1A4A3A2C31
P-H	5910-850-9074	CAPACITOR, FIXED, MICA DIELECTRIC 22H5Q33DJ (14655)	EA	2				*	*	*	*	*	3-10	1A4A3A2C32
P-H	5910-850-9074	CAPACITOR, FIXED, MICA DIELECTRIC 22H5Q33DJ (14655)	EA	REF				*	*	*	*	*	3-10	1A4A3A2C33
P-H	5910-838-9421	CAPACITOR, FIXED, CERAMIC DIELECTRIC CK60AW102M (81349)	EA	2				*	*	*	*	*	3-10	1A4A3A2C29
P-H	5910-838-9421	CAPACITOR, FIXED, CERAMIC DIELECTRIC CK60AW102M (81349)	EA	REF				*	*	*	*	*	3-10	1A4A3A2C30
P-F	5910-822-5233	CAPACITOR, FIXED, CERAMIC DIELECTRIC 20C109 (01939)	EA	2				*	*	*	*	*	3-10	1A4A3A2C2
P-F	5910-822-5233	CAPACITOR, FIXED, CERAMIC DIELECTRIC 20C109 (01939)	EA	REF				*	*	*	*	*	3-10	1A4A3A2C7
P-H	5910-823-1078	CAPACITOR; SELECT FROM CAPACITOR, FIXED CERAMIC 29C2% (56289) -OR-	EA	1				*	*	*	*	*		1A4A3A2C26
P-H	5910-823-1079	CAPACITOR, FIXED CERAMIC 55C43 (56289) -OR-	EA	1				*	*	*	*	*		1A4A3A2C26
P-H	5910-027-9976	CAPACITOR, FIXED CERAMIC 851-500P30C101J (72982) -OR-	EA	1				*	*	*	*	*		1A4A3A2C26
P-H	5910-823-1080	CAPACITOR, FIXED CERAMIC 19C11A2 (56289) -OR-	EA	1				*	*	*	*	*		1A4A3A2C26

SECTION III REPAIR PARTS FOR DIRECT SUPPORT, GENERAL SUPPORT, AND DEPOT MAINTENANCE (CONTINUED)

(1) SIB CODE	(2) FEDERAL STOCK NUMBER	(3) DESCRIPTION  USABLE ON CODE	(4) UNIT OF MEAS	(5) QTY REQ'D UNIT	(6) 30-DAY DS MAINT ALLOWANCE			(7) 30-DAY GS MAINT ALLOWANCE			(8) 1 YR ALY PER EQUIP CONTACT	(9) DEPOT MAINT ALY PER 100 EQUIP	(10) ILLUSTRATIONS	
					(a)	(b)	(c)	(a)	(b)	(c)			(a)	(b)
					1-20	21-50	51-100	1-20	21-50	51-100			1-20	21-50
P-H	5910-823-1081	OR, FIXED, CERAMIC DIELECTRIC (56289)	EA	1				*	*	*	*	*		1A4A3A2C26
P-H	5910-823-1078	OR; SELECT FROM OR, FIXED, CERAMIC DIELECTRIC (56289)	EA	1				*	*	*	*	*	3-10	1A4A3A2C27
P-H	5910-823-1079	R- OR, FIXED, CERAMIC DIELECTRIC (56289)	EA	1				*	*	*	*	*	3-10	1A4A3A2C27
P-H	5910-027-9976	R- OR, FIXED, CERAMIC DIELECTRIC P3K101J (72982)	EA	1				*	*	*	*	*	3-10	1A4A3A2C27
P-H	5910-823-1080	R- OR, FIXED, CERAMIC DIELECTRIC (56289)	EA	1				*	*	*	*	*	3-10	1A4A3A2C27
P-H	5910-823-1081	R- OR, FIXED, CERAMIC DIELECTRIC (56289)	EA	1				*	*	*	*	*	3-10	1A4A3A2C27
P-H	5910-702-7381	OR, FIXED, PAPER DIELECTRIC J02S3 (56289)	EA	1				*	*	*	*	*	3-10	1A4A3A2C18
P-H	5910-765-6226	OR, FIXED, MICA DIELECTRIC 4EJ (14655)	EA	1				*	*	*	*	*		1A4A3A2C9
P-H	5910-688-2993	OR, FIXED, PAPER DIELECTRIC J01S3 (56289)	EA	1				*	*	*	*	*	3-10	1A4A3A2C1
P-H	5910-686-6929	OR, FIXED, PAPER DIELECTRIC J02S3 (56289)	EA	5				*	*	*	*	*	3-10	1A4A3A2C14
P-H	5910-686-6929	OR, FIXED, PAPER DIELECTRIC J02S3 (56289)	EA	REF				*	*	*	*	*	3-10	1A4A3A2C15
P-H	5910-686-6929	OR, FIXED, PAPER DIELECTRIC J02S3 (56289)	EA	REF				*	*	*	*	*	3-10	1A4A3A2C17
P-H	5910-686-6929	OR, FIXED, PAPER DIELECTRIC J02S3 (56289)	EA	REF				*	*	*	*	*	3-10	1A4A3A2C19
P-H	5910-686-6929	OR, FIXED, PAPER DIELECTRIC J02S3 (56289)	EA	REF				*	*	*	*	*	3-10	1A4A3A2C22
P-F	5302-764-2966	MACHINE 3-2 (96906)	EA	REF	*	*	*	*	*	*	*	*		
M-H		RUBBER 15-002 (13499)	EA	REF										
P-F	5305-054-3644	MACHINE 7-11 (96905)	EA	5	*	*	*	*	*	*	*	*		
P-H		LAIN, ROUND 75-002 (13499)	EA	7				*	*	*	*	*		
XI-H		FIBR SLEEVING, ELECTRICAL 2-6 (81851)	FT	REF										
M-H		FIBR SLEEVING, ELECTRICAL 2-5 (81851)	FT	REF										
M-H		FIBR SLEEVING, ELECTRICAL 2-4 (81851)	FT	REF										
M-H		RADIO FREQUENCY U (96058)	FT	REF										
P-H		ELECTRICAL 878TYPE22-925 (81349)	FT	1				*	*	*	*	*		
P-H	5905-064-0555	OR, FIXED, FILM 002F (81349)	EA	1				*	*	*	*	*	3-10	1A4A3A2R5
P-H	5905-171-1986	OR, FIXED, COMPOSITION 563J (81349)	EA	1				*	*	*	*	*	3-10	1A4A3A2R30
P-H	5910-760-7919	OR, FIXED, MICA DIELECTRIC 4EJ (14655)	EA	1				*	*	*	*	*	3-10	1A4A3A2C34
P-H	5910-822-7335	OR, FIXED, ELECTROLYTIC 7X0006R2 (56289)	EA	1				*	*	*	*	*	3-10	1A4A3A2C12

SECTION III REPAIR PARTS FOR DIRECT SUPPORT, GENERAL SUPPORT, AND DEPOT MAINTENANCE (CONTINUED)

(1) SR CODE	(2) FEDERAL STOCK NUMBER	(3) DESCRIPTION  USABLE ON CODE	(4) UNIT OF MEAS	(5) QTY INC IN UNIT	(6) 30-DAY DS MAINT ALLOWANCE			(7) 30-DAY GS MAINT ALLOWANCE			(8) 1 YR ALW PER EQUIP CNTCTY	(9) DEPOT MAINT ALW PER 100 EQUIP	(10) ILLUSTRATIONS	
					(a)	(b)	(c)	(a)	(b)	(c)			(a) FIG NO.	(b) ITEM NO. OR REFERENCE DESIGNATION
					1-20	21-50	51-100	1-20	21-50	51-100				
M-H		INSULATION SLEEVING, ELECTRICAL TEFTW12B (81851)	FT	4										
P-H	5910-823-1082	CAPACITOR; SELECT FROM CAPACITOR, FIXED, CERAMIC DIELECTRIC 29C297 (56289)	EA	1		*	*	*	*	*				1A4A3A2C35
P-H	5910-823-1083	-OR- CAPACITOR, FIXED, CERAMIC DIELECTRIC 29C35A3 (56289)	EA	1		*	*	*	*	*				1A4A3A2C35
P-H	5910-823-1084	-OR- CAPACITOR, FIXED, CERAMIC DIELECTRIC 29C35A4 (56289)	EA	1		*	*	*	*	*				1A4A3A2C35
P-H	5910-823-1085	-OR- CAPACITOR, FIXED, CERAMIC DIELECTRIC 19C388 (56289)	EA	1		*	*	*	*	*				1A4A3A2C35
P-H	5910-823-1086	-OR- CAPACITOR, FIXED, CERAMIC DIELECTRIC 19C28A1 (56289)	EA	1		*	*	*	*	*				1A4A3A2C35
P-H	5910-823-1087	-OR- CAPACITOR, FIXED, CERAMIC DIELECTRIC 40C157A1 (56289)	EA	1		*	*	*	*	*				1A4A3A2C35
P-H	5910-903-6951	-OR- CAPACITOR, FIXED, CERAMIC DIELECTRIC 53C46 (56289)	EA	1		*	*	*	*	*				1A4A3A2C35
P-H	5910-823-1077	-OR- CAPACITOR, FIXED, CERAMIC DIELECTRIC 53C45 (56289)	EA	1		*	*	*	*	*				1A4A3A2C35
P-H	5910-823-1082	CAPACITOR; SELECT FROM CAPACITOR, FIXED, CERAMIC DIELECTRIC 29C297 (56289)	EA	1		*	*	*	*	*				1A4A3A2C36
P-H	5910-823-1083	-OR- CAPACITOR, FIXED, CERAMIC DIELECTRIC 29C35A3 (56289)	EA	1		*	*	*	*	*				1A4A3A2C36
P-H	5910-823-1084	-OR- CAPACITOR, FIXED, CERAMIC DIELECTRIC 29C35A4 (56289)	EA	1		*	*	*	*	*				1A4A3A2C36
P-H	5910-823-1085	-OR- CAPACITOR, FIXED, CERAMIC DIELECTRIC 19C388 (56289)	EA	1		*	*	*	*	*				1A4A3A2C36
P-H	5910-823-1086	-OR- CAPACITOR, FIXED, CERAMIC DIELECTRIC 19C28A1 (56289)	EA	1		*	*	*	*	*				1A4A3A2C36
P-H	5910-823-1087	-OR- CAPACITOR, FIXED, CERAMIC DIELECTRIC 40C157A1 (56289)	EA	1		*	*	*	*	*				1A4A3A2C36
P-H	5910-93-6951	-OR- CAPACITOR, FIXED, CERAMIC DIELECTRIC 53C46 (56289)	EA	1		*	*	*	*	*				1A4A3A2C36
P-H	5910-823-1077	-OR- CAPACITOR, FIXED, CERAMIC DIELECTRIC 53C45 (56289)	EA	1		*	*	*	*	*				1A4A3A2C36
P-F	5305-054-5646	SCREW, MACHINE MS51957-12 (96906)	EA	REF	*	*	*	*	*	*				
P-F		TERMINAL, LIG 4007-4HOTTINNED (77147)	EA	REF	*	*	*	*	*	*				
M-H		WIRE, ELECTRICAL 00702-1322 (70567)	FT	REF										
P-F	5310-058-2949	WASHER, LOCK MS35337-78 (96906)	EA	REF	*	*	*	*	*	*				
P-H		WASHER, FLAT 310-0054-000 (79807)	EA	19		*	*	*	*	*				
M-H		INSULATION SLEEVING, ELECTRICAL TEFTW198 (81851)	FT	8										
M-H		INSULATION SLEEVING, ELECTRICAL TEFTW13B (81851)	FT	REF										
P-H	5820-023-3671	AMPLIFIER, DIRECT CURRENT 548-558-004 (13499)	EA	1		*	*	*	*	*				1A4A3A8
P-H	5999-1949	PRINTED CIRCUIT BOARD 546-7884-004 (13499)	EA	1		*	*	*	*	*		3-11		1A4A3A8TB1
XL-H		PRINTED CIRCUIT BOARD 546-7883-004 (13499)	EA	1										



SECTION III REPAIR PART FOR DIRECT SUPPORT, GENERAL SUPPORT, AND DEPOT MAINTENANCE (CONTINUED)

(1) SUB CODE	(2) FEDERAL STOCK NUMBER	(3) DESCRIPTION  REFERENCE NUMBER & MFR. CODE	(4) UNIT OF MEAS	(5) QTY REQ'D IN UNIT	(6) 30-DAY DS MAINT ALLOWANCE			(7) 30-DAY GS MAINT ALLOWANCE			(8) 1 YR ALW PER EQUIP CNTGCTY	(9) DEPOT MAINT ALW PER 100 EQUIP	(10) ILLUSTRATIONS	
					(a) 1-20	(b) 21-50	(c) 51-100	(a) 1-20	(b) 21-50	(c) 51-100			(a) FIG NO.	(b) ITEM NO. OR REFERENCE DESIGNATION
XI-H		RYELET, METALLIC 542-0810-003 (13499)	EA	REF										
P-H		TERMINAL, STUD 542-4085-002 (13499)	EA	REF				*	*	*	*	*		
P-H	5960-261-8679	ELECTRON TUBE 6021 (49956)	EA	1				*	*	*	*	*	3-11 1A4A3ABV1	
P-H	5905-801-5430	RESISTOR, VARIABLE 224L1-203 (80294)	EA	1				*	*	*	*	*	3-11 1A4A3ABR1	
P-H	5905-228-6088	RESISTOR, FIXED, COMPOSITION RC32GF33J (81349)	EA	1				*	*	*	*	*	3-11 1A4A3ABR6	
P-H	5905-299-2049	RESISTOR, FIXED, COMPOSITION RC32GF561K (81349)	EA	1				*	*	*	*	*	3-11 1A4A3ABR5	
P-H	5905-195-6741	RESISTOR, FIXED, COMPOSITION RC20GF272K (81349)	EA	2				*	*	*	*	*	3-11 1A4A3ABR2	
P-H	5905-195-6741	RESISTOR, FIXED, COMPOSITION RC20GF272K (81349)	EA	REF				*	*	*	*	*	3-11 1A4A3ABR3	
P-H	5905-081-6381	RESISTOR, FIXED, FIM RM65D191F (81349)	EA	1				*	*	*	*	*	3-11 1A4A3ABR7	
P-H		NUT, PLAIN, ROUND 543-1675-002 (13499)	EA	REF				*	*	*	*	*		
P-H	5340-601-0417	RETAINER, ELECTRICAL 100-200-16 (99378)	EA	1				*	*	*	*	*		
P-H	5960-557-6126	SHIELD, ELECTRON 109-501-4 (99378)	EA	REF				*	*	*	*	*		
P-H	5305-054-5639	SCREW, MACHINE MS51957-5 (96906)	EA	3				*	*	*	*	*		
P-H	5305-054-5636	SCREW, MACHINE MS51957-2 (96906)	EA	REF				*	*	*	*	*		
P-F	5305-054-5644	SCREW, MACHINE MS51957-11 (96906)	EA	REF			*	*	*	*	*	*		
P-F		WASHER, FLAT 502-1515-002 (13499)	EA	REF			*	*	*	*	*	*		
P-F	5310-595-5421	WASHER, FLAT 310-6320-000 (79807)	EA	REF			*	*	*	*	*	*		
M-H		INSULATION SLEEVING, ELECTRICAL TEPTW22-2 (81851)	FT	4										
M-H		INSULATION SLEEVING, ELECTRICAL TEPTW22-3 (81851)	FT	REF										
M-H		INSULATION SLEEVING, ELECTRICAL TEPTW22-7 (81851)	FT	1										
M-H		INSULATION SLEEVING, ELECTRICAL TEPTW22-1 (81851)	FT	REF										
M-H		INSULATION SLEEVING, ELECTRICAL TEPTW22-0 (81851)	FT	REF										
XI-H		INSULATION SLEEVING, ELECTRICAL TEPTW22-6 (81851)	FT	REF										
M-H		INSULATION SLEEVING, ELECTRICAL TEPTW22-5 (81851)	FT	REF										
M-H		INSULATION SLEEVING, ELECTRICAL TEPTW22-4 (81851)	FT	REF										
P-H	5961-060-7587	SEMICONDUCTOR DEVICE, DIODE 1N816 (07688)	EA	2				*	*	*	*	*	3-11 1A4A3ABCR1	
P-H	5961-060-7587	SEMICONDUCTOR DEVICE, DIODE 1N816 (07688)	EA	REF				*	*	*	*	*	3-11 1A4A3ABCR2	

SECTION III REPAIR PART FOR DIRECT SUPPORT, GENERAL SUPPORT, AND DEPOT MAINTENANCE (CONTINUED)

(1) SRR CODE	(2) FEDERAL STOCK NUMBER	(3) DESCRIPTION  USABLE ON CODE	(4) UNIT OF MEAS	(5) QTY INC IN UNIT	(6) 30-DAY DS MAINT ALLOWANCE			(7) 30-DAY GS MAINT ALLOWANCE			(8) 1 YR ALW PER EQUIP CATGCT	(9) DEPOT MAINT ALW PER 100 EQUIP	(10) ILLUSTRATIONS	
					(a) 1-20	(b) 21-50	(c) 51-100	(a) 1-20	(b) 21-50	(c) 51-100			(a) FIG NO.	(b) ITEM NO. OR REFERENCE DESIGNATION
P-F	5305-054-5646	SCREW, MACHINE MS51957-12 (96906)	EA	REF	*	*	*	*	*	*	*			
XI-H		SINK, HEAT 545-6622-002 (13499)	EA	1										
P-F		NUT, PLAIN, HEXAGON MS35649-24 (96906)	EA	REF	*	*	*	*	*	*	*			
X2-H		BRACE, RIGHT 543-1729-002 (13499)	EA	1										
P-F	5310-918-7213	NUT, CAPTIVE NCN4-2-2-1 (07886)	EA	REF	*	*	*	*	*	*	*			
X2-H		BRACE, RIGHT TOP 543-1728-002 (13499)	EA	1										
P-H	5950-583-0904	CORE, ADJUSTABLE TUNER 57-802 (78488)	EA	5				*	*	*	*		1A4A3A8E23	
P-H	5950-583-0904	CORE, ADJUSTABLE TUNER 57-802 (78488)	EA	REF				*	*	*	*		1A4A3A8E24	
P-H	5950-583-0904	CORE, ADJUSTABLE TUNER 57-802 (78488)	EA	REF				*	*	*	*		1A4A3A8E25	
P-H	5950-583-0904	CORE, ADJUSTABLE TUNER 57-802 (78488)	EA	REF				*	*	*	*		1A4A3A8E26	
P-H	5950-583-0904	CORE, ADJUSTABLE TUNER 57-802 (78488)	EA	REF				*	*	*	*		1A4A3A8E27	
XI-H		CLAMP, DRUM 506-3189-002 (13499)	EA	1										
P-H	5820-679-9386	OSCILLATOR 542-5720-003 (13499)	EA	1				*	*	*	*		1A4A3A5	
P-F		WASHER, FLAT 541-1206-003 (13499)	EA	1	*	*	*	*	*	*	*			
P-H	5120-684-0485	TUNING WAND 543-1723-002 (13499)	EA	1				*	*	*	*			
XI-H		HOLDER, BIT, TUNING WAND 543-1721-002 (13499)	EA	1										
XI-H		BIT, TUNING WAND 543-1722-002 (13499)	EA	1										
P-F		WASHER, FLAT 310-6360-000 (79807)	EA	REF	*	*	*	*	*	*	*			
P-F	5910-678-5306	CAPACITOR, FIXED, CERAMIC DIELECTRIC DA049-123B (71590)	EA	1	*	*	*	*	*	*	*	3-6	1A4A3C18	
P-F	5910-978-0993	CAPACITOR, FIXED, PAPER DIELECTRIC NFTHLFL (14655)	EA	2	*	*	*	*	*	*	*		1A4A3C41	
P-F	5910-978-0993	CAPACITOR, FIXED, PAPER DIELECTRIC NFTHLPL (14655)	EA	REF	*	*	*	*	*	*	*		1A4A3C42	
P-F	5950-991-3367	COIL, RADIO FREQUENCY LT7K205 (81349)	EA	1	*	*	*	*	*	*	*		1A4A3L7	
P-F		NUT, PLAIN, HEXAGON P334-0254-000 (77250)	EA	REF	*	*	*	*	*	*	*			
P-F		WASHER, LOCK 1218-02CADPL (78189)	EA	REF	*	*	*	*	*	*	*			
P-F	55305-763-7827	SCREW, MACHINE MS51959-18 (96906)	EA	6	*	*	*	*	*	*	*			
P-H		SHIELD, ELECTRICAL 543-3447-003 (13499)	EA	1				*	*	*	*			
P-F		NUT, PLAIN, CAPTIVE 334-0043-000 (21537)	EA	2	*	*	*	*	*	*	*			

SECTION III REPAIR PART FOR DIRECT SUPPORT, GENERAL SUPPORT, AND DEPOT MAINTENANCE (CONTINUED)

(1) SIR CODE	(2) FEDERAL STOCK NUMBER	(3) DESCRIPTION  REFERENCE NUMBER & MFR. CODE	(4) UNIT OF MEAS	(5) QTY INC IN UNIT	(6) 30-DAY DS MAINT ALLOWANCE			(7) 30-DAY GS MAINT ALLOWANCE			(8) 1 YR ALW PER EQUIP CATGRY	(9) DEPOT MAINT ALW PER 100 EQUIP	(10) ILLUSTRATIONS	
					(a) 1-20	(b) 21-50	(c) 51-100	(a) 1-20	(b) 21-50	(c) 51-100			(a) FIG NO.	(b) ITEM NO. OR REFERENCE DESIGNATION
P-H	5905-106-1282	RESISTOR, FIXED, COMPOSITION RC20GF223K (81349)	EA	1				*	*	*	*	*		1A4A3R33
P-F		SCREW, MACHINE P343-0282-000 (77250)	EA	8	*	*	*	*	*	*	*	*		
XI-H		CLAMP, CABLE 541-1021-002 (13499)	EA	REF										
M-H		WIRE, ELECTRICAL 00702-1322 (70567)	FT	REF										
P-F		SPRING, HELICAL 544-6182-002 (13499)	EA	1	*	*	*	*	*	*	*	*		
X2-H		PIN, GROOVED 544-6181-002 (13499)	EA	1										
P-H	5821-810-2607	OSCILLATOR 522-1768-014 (13499)	EA	1				*	*	*	*	*		1A4A3A1
A-F-R		OSCILLATOR 543-1501-004 (13499)	EA	1									3-4	1A4A2
P-F	5305-305-764-2966	SCREW, MACHINE MS51959-2 (96906)	EA	REF	*	*	*	*	*	*	*	*		
P-F	5305-727-8833	SCREW, MACHINE MS51959-3 (96906)	EA	31	*	*	*	*	*	*	*	*		
P-F	5305-770-2533	SCREW, MACHINE MS51959-13 (96906)	EA	REF	*	*	*	*	*	*	*	*		
P-F	5305-763-6955	SCREW, MACHINE MS51959-21 (96906)	EA	REF	*	*	*	*	*	*	*	*		
P-F	5305-777-6039	SCREW, MACHINE MS51959-12 (96906)	EA	REF	*	*	*	*	*	*	*	*		
P-F	53005-054-5647	SCREW, MACHINE MS51957-13 (96906)	EA	REF	*	*	*	*	*	*	*	*		
P-F		SCREW, MACHINE 330-2348-000 (70601)	EA	1	*	*	*	*	*	*	*	*		
P-F	5340-200-2637	RING, RETAINING MS16624-12 (96906)	EA	REF	*	*	*	*	*	*	*	*		
M-H		WIRE, ELECTRICAL 00702-1322 (70567)	FT	REF										
A-F		SHIELD ASSEMBLY 542-4782-002 (13499)	EA	4									3-12	1A4A2E1
A-F		SHIELD ASSEMBLY 542-4782-002 (13499)	EA	REF									3-12	1A4A2E2
A-F		SHIELD ASSEMBLY 542-4782-002 (13499)	EA	REF									3-12	1A4A2E3
A-F		SHIELD ASSEMBLY 542-4782-002 (13499)	EA	REF									3-12	1A4A2E4
P-F		RETAINER, ELECTRON TUBE 542-0371-002 (13499)	EA	14	*	*	*	*	*	*	*	*		
P-F		SHIELD, TUBE 542-0375-002 (13499)	EA	14	*	*	*	*	*	*	*	*		
XI-F		SHIELD-EXTRUDED 542-0378-012 (13499)	EA	14										
P-F		PIN, SHOULDERED 543-1833-002 (13499)	EA	2	*	*	*	*	*	*	*	*		
P-F		WASHER 543-1834-002 (13499)	EA	2	*	*	*	*	*	*	*	*		
XI-F		PLATE, HOLE 543-1835-002 (13499)	EA	2										

SECTION III REPAIR PART FOR DIRECT SUPPORT, GENERAL SUPPORT, AND DEPOT MAINTENANCE (CONTINUED)

(1) SRR CODE	(2) FEDERAL STOCK NUMBER	(3) DESCRIPTION  USABLE ON CODE	(4) UNIT OF MEAS	(5) QTY INC IN UNIT	(6) 30-DAY GS MAINT ALLOWANCE			(7) 30-DAY GS MAINT ALLOWANCE			(8) 1 YR ALW PER EQUIP CATGRY	(9) DEPOT MAINT ALW PER 100 EQUIP	(10) ILLUSTRATIONS	
					(a) 1-20	(b) 21-50	(c) 51-100	(a) 1-20	(b) 21-50	(c) 51-100			(a) FIG NO.	(b) ITEM NO. OR REFERENCE DESIGNATION
P-F		PROD, TEST-PRESSED 543-1838-002 (13499)	EA	4	*	*	*	*	*	*	*			
X2-H		HOLDER, TEST PROD 543-1832-002 (13499)	EA	4										
X2-F		JACK, TIP SKT41WHT (98291)	EA	1								3-12	1A4A271	
P-H		SCREW, SHIELD 542-7683-002 (13499)	EA	REF				*	*	*	*			
X2-H		FRAME-RIVETED 543-2495-002 (13499)	EA	1										
X2-H		FRAME CHASSIS 543-2313-004 (13499)	EA	1										
P-H		BRACKET, RETAINER 542-7768-002 (13499)	EA	REF				*	*	*	*			
X2-H	55320-117-6010	RIVET, SOLID MS20426AD2-3 (96906)	EA	REF										
X2-H		PLATE, BASE 543-2492-002 (13499)	EA	1										
X2-H		PLATE, BASE 543-2497-003 (13499)	EA	1										
X2-H		PLATE, CASTING 543-1494-014 (13499)	EA	REF										
P-H		PIN, LOCATING 541-6556-002 (13499)	EA	REF				*	*	*	*			
X2-H		PLATE, CHASSIS 543-2493-002 (13499)	EA	1										
P-F	55310-050-6833	NUT, SELF-LOCKING CLINCHED F22NCFM1-40 (72962)	EA	15	*	*	*	*	*	*	*			
X2-H		PLATE, CHASSIS 543-2503-004 (13499)	EA	1										
P-F		NUT, PLAIN 543-1830-002 (13499)	EA	3	*	*	*	*	*	*	*			
P-F		NUT, PLAIN 543-1829-002 (13499)	EA	9	*	*	*	*	*	*	*			
P-H	55820-678-5083	OSCILLATOR 543-2514-004 (13499)	EA	1				*	*	*	*		1A4A223	
P-H	55935-615-2183	SOCKET ASSEMBLY, RELAY 33-817 (02660)	EA	1				*	*	*	*	3-12	1A4A2X11	
P-F		INSULATION SLEEVING, ELECTRICAL TEFTW22B (81851)	FT	REF	*	*	*	*	*	*	*			
M-H		INSULATION SLEEVING, ELECTRICAL TEFTW22-3 (81851)	FT	REF										
M-H		INSULATION SLEEVING, ELECTRICAL TEFTW22-1 (81851)	FT	REF										
M-H		INSULATION SLEEVING, ELECTRICAL TEFTW22-0 (81851)	FT	REF										
X1-H		INSULATION SLEEVING, ELECTRICAL TEFTW22-6 (81851)	FT	REF										
M-H		INSULATION SLEEVING, ELECTRICAL TEFTW22-5 (81851)	FT	REF										
M-H		INSULATION SLEEVING, ELECTRICAL TEFTW22-4 (81851)	FT	REF										
P-H	5950-683-3461	COIL, RADIO FREQUENCY 18-184 (09250)	EA	2				*	*	*	*	3-12	1A4A211	

SECTION III REPAIR PART FOR DIRECT SUPPORT, GENERAL SUPPORT, AND DEPOT MAINTENANCE (CONTINUED)

(1) SR CODE	(2) FEDERAL STOCK NUMBER	(3) DESCRIPTION  REFERENCE NUMBER & MFR. CODE	(4) UNIT OF MEAS	(5) QTY INC IN UNIT	(6) 30-DAY DS MAINT ALLOWANCE			(7) 30-DAY GS MAINT ALLOWANCE			(8) 1 YR ALM PER EQUIP CWTGCT	(9) DEPOT MAINT ALM PER 100 EQUIP	(10) ILLUSTRATIONS	
					(a) 1-20	(b) 21-50	(c) 51-100	(a) 1-20	(b) 21-50	(c) 51-100			(a) FIG NO.	(b) ITEM NO. OR REFERENCE DESIGNATION
P-H	5960-230-5226	ELECTRON TUBE 5636 (82219)	EA	2				*	*	*	*	*	3-12	1A4A2V1
P-H	5960-230-5226	ELECTRON TUBE 5636 (82219)	EA	REF				*	*	*	*	*	3-12	1A4A2V2
P-H	5961-818-4487	TRANSISTOR 2N1150 (07688)	EA	2				*	*	*	*	*	3-12	1A4A2Q1
P-H	5961-818-4487	TRANSISTOR 2N1150 (07688)	EA	REF				*	*	*	*	*	3-12	1A4A2Q2
M-H		WIRE, ELECTRICAL 00702-1322 (70567)	FT	REF										
M-H		CABLE, RADIO FREQUENCY RG187AU (80058)	FT	2										
P-H	5910-771-5605	CAPACITOR, FIXED ELECTROLYTIC C124BQ10SP3 (81349)	EA	1				*	*	*	*	*	3-12	1A4A2C5
P-H		CLIP SPRING 543-1044-002 (13499)	EA	2				*	*	*	*	*		
P-H	5999-793-0194	PRINTED CIRCUIT BOARD 543-2499-003 (13499)	EA	1				*	*	*	*	*	3-12	1A4A2TB1
P-H		TERMINAL, STUD 542-4085-002 (13498)	EA	REF				*	*	*	*	*		
XI-H		EYELET, METALLIC A25 HOTTINNED (57771)	EA	REF										
XI-H		EYELET, METALLIC 542-0810-003 (13499)	EA	REF										
XI-H		PRINTED CIRCUIT BOARD 543-2508-004 (13499)	EA	1										
XI-H		TUBELET 542-0812-003 (13499)	EA	2										
P-H	5905-171-2005	RESISTOR, FIXED, COMPOSITION RC20GF471K (81349)	EA	1				*	*	*	*	*	3-12	1A4A2R6
P-H	5905-195-6453	RESISTOR, FIXED, COMPOSITION RC20GF562K (81349)	EA	1				*	*	*	*	*	3-12	1A4A2R8
P-H	5905-195-6541	RESISTOR, FIXED, COMPOSITION RC20GF472K (81349)	EA	1				*	*	*	*	*	3-12	1A4A2R1
P-F	5905-141-0595	RESISTOR, FIXED, COMPOSITION RC20GF682K (81349)	EA	1	*	*	*	*	*	*	*	*	3-12	1A4A2R9
P-F	5905-141-0591	RESISTOR, FIXED, COMPOSITION RC20GF103K (81349)	EA	1	*	*	*	*	*	*	*	*	3-12	1A4A2R7
P-F	5905-106-1273	RESISTOR, FIXED, COMPOSITION RC20GF153J (81349)	EA	1	*	*	*	*	*	*	*	*	3-12	1A4A2R12
P-H	5905-192-3987	RESISTOR, FIXED, COMPOSITION RC20GF104K (81349)	EA	2				*	*	*	*	*	3-12	1A4A2R10
P-H	5905-192-3987	RESISTOR, FIXED, COMPOSITION RC20GF104K (81349)	EA	REF				*	*	*	*	*	3-12	1A4A2R14
P-H	5905-106-9345	RESISTOR, FIXED, COMPOSITION RC20GF683J (81349)	EA	2				*	*	*	*	*	3-12	1A4A2R3
P-H	5905-106-9345	RESISTOR, FIXED, COMPOSITION RC20GF683J (81349)	EA	REF				*	*	*	*	*	3-12	1A4A2R11
P-H	5905-221-5860	RESISTOR, FIXED, COMPOSITION RC20GF334K (81349)	EA	2				*	*	*	*	*	3-12	1A4A2R4
P-H	5905-221-5860	RESISTOR, FIXED, COMPOSITION RC20GF334K (81349)	EA	REF				*	*	*	*	*	3-12	1A4A2R5
P-H	5910-850-9074	CAPACITOR, FIXED, MICA DIELECTRIC 22H5Q33V (14655)	EA	1				*	*	*	*	*	3-12	1A4A2C1

SECTION III REPAIR PART FOR DIRECT SUPPORT, GENERAL SUPPORT, AND DEPOT MAINTENANCE (CONTINUED)

(1) SR CODE	(2) FEDERAL STOCK NUMBER	(3) DESCRIPTION	(4) UNIT OF MEAS	(5) QTY INC IN UNIT	(6) 30-DAY DS MAINT ALLOWANCE			(7) 30-DAY GS MAINT ALLOWANCE			(8) 1 YR ALW PER EQUIP CATEGY	(9) DEPOT MAINT ALW PER 100 EQUIP	(10) ILLUSTRATIONS		
					USABLE ON CODE	(a) 1-20	(b) 21-50	(c) 51-100	(a) 1-20	(b) 21-50			(c) 51-100	(a) FIG NO.	(b) ITEM NO. OR REFERENCE DESIGNATION
P-H	5910-663-4759	CAPACITOR, FIXED, MICA DIELECTRIC 22H5Q2CJ (14655)	EA	1				*	*	*	*	*	3-12	1A4A2C16	
P-H	5910-901-8796	CAPACITOR, FIXED, MICA DIELECTRIC 22H5Q56EJ (14655)	EA	1				*	*	*	*	*	3-12	1A4A2C13	
P-H	5910-984-8375	CAPACITOR, FIXED, MICA DIELECTRIC 22H5T11EJ (14655)	EA	2				*	*	*	*	*	3-12	1A4A2C4	
P-H	5910-725-1993	CAPACITOR, FIXED, MICA DIELECTRIC 22H5T2EJ (14655)	EA	2				*	*	*	*	*	3-12	1A4A2C17	
P-H	5910-655-0390	CAPACITOR, FIXED, PAPER DIELECTRIC SDBLK01153M (53021)	EA	1				*	*	*	*	*	3-12	1A4A2C7	
P-H	5910-617-3246	CAPACITOR, FIXED, PAPER DIELECTRIC SDBLK02353M (53021)	EA	1				*	*	*	*	*	3-12	1A4A2C2	
P-H	5910-542-7518	CAPACITOR, FIXED, PAPER DIELECTRIC P107069 (56289)	EA	10				*	*	*	*	*	3-12	1A4A2C6	
P-H	5910-542-7518	CAPACITOR, FIXED, PAPER DIELECTRIC P107069 (56289)	EA	REF				*	*	*	*	*	3-12	1A4A2C8	
P-H	5910-542-7518	CAPACITOR, FIXED, PAPER DIELECTRIC P107069 (56289)	EA	REF				*	*	*	*	*	3-12	1A4A2C10	
P-H	5910-542-7518	CAPACITOR, FIXED, PAPER DIELECTRIC P107069 (56289)	EA	REF				*	*	*	*	*	3-12	1A4A2C11	
P-H	5910-542-7518	CAPACITOR, FIXED, PAPER DIELECTRIC P107069 (56289)	EA	REF				*	*	*	*	*	3-12	1A4A2C12	
P-H	5910-542-7518	CAPACITOR, FIXED, PAPER DIELECTRIC P107069 (56289)	EA	REF				*	*	*	*	*	3-12	1A4A2C15	
P-H	5910-542-7518	CAPACITOR, FIXED, PAPER DIELECTRIC P107069 (56289)	EA	REF				*	*	*	*	*	3-12	1A4A2C31	
P-H	5910-542-7517	CAPACITOR, FIXED, PAPER DIELECTRIC P107100 (56289)	EA	1				*	*	*	*	*	3-12	1A4A2C14	
P-H	5905-171-1998	RESISTOR, FIXED, COMPOSITION RC20GF333K (81349)	EA	1				*	*	*	*	*	3-12	1A4A2R2	
P-H	5910-978-6417	CAPACITOR, FIXED, PAPER DIELECTRIC SDA3K02682M (53021)	EA	3				*	*	*	*	*	3-12	1A4A2C3	
P-H	5910-978-6417	CAPACITOR, FIXED, PAPER DIELECTRIC SDA3K02682M (53021)	EA	REF				*	*	*	*	*	3-12	1A4A2C9	
P-H	5945-080-5561	RELAY ARMATURE 95-2944 (04221)	EA	2				*	*	*	*	*	3-12	1A4A2K1	
P-H	5945-080-5561	RELAY ARMATURE 95-2944 (04221)	EA	REF				*	*	*	*	*	3-12	1A4A2K2	
M-H		INSULATION SLEEVING, ELECTRICAL TEFTW22-2 (81851)	FT	REF											
P-H	5905-171-1986	RESISTOR, FIXED, COMPOSITION RC20GF563J (81349)	EA	1				*	*	*	*	*	3-12	1A4A2R13	
P-F	5305-770-2533	SCREW, MACHINE MS1959-13 (96906)	EA	REF	*	*	*	*	*	*	*	*			
P-H	5820-678-5082	AMPLIFIER 543-2515-004 (13499)	EA	1				*	*	*	*	*		1A4A2Z2	
P-F		INSULATION SLEEVING, ELECTRICAL TEFTW22B (81851)	FT	REF	*	*	*	*	*	*	*	*			
M-H		INSULATION SLEEVING, ELECTRICAL TEFTW22-2 (81851)	FT	REF											
M-H		INSULATION SLEEVING, ELECTRICAL TEFTW22-3 (81851)	FT	REF											
M-H		INSULATION SLEEVING, ELECTRICAL TEFTW22-1 (81851)	FT	REF											

SECTION III REPAIR PART FOR DIRECT SUPPORT, GENERAL SUPPORT, AND DEPOT MAINTENANCE (CONTINUED)

(1) SIR CODE	(2) FEDERAL STOCK NUMBER	(3) DESCRIPTION  REFERENCE NUMBER & MFR. CODE	(4) UNIT OF MEAS	(5) QTY INC IN UNIT	(6) 30-DAY GS MAINT ALLOWANCE			(7) 30-DAY GS MAINT ALLOWANCE			(8) 1 YR ALM PER EQUIP CNTCY	(9) DEPOT MAINT ALM PER 100 EQUIP	(10) ILLUSTRATIONS		
					USABLE ON CODE	(a) 1-20	(b) 21-50	(c) 51-100	(a) 1-20	(b) 21-50			(c) 51-100	(a) FIG NO.	(b) ITEM NO. OR REFERENCE DESIGNATION
M-H		INSULATION SLEEVING, ELECTRICAL TEFTW22-0 (81851)	FT	REF											
XI-H		INSULATION SLEEVING, ELECTRICAL TEFTW22-6 (81851)	FT	REF											
M-H		INSULATION SLEEVING, ELECTRICAL TEFTW22-5 (81851)	FT	REF											
M-H		INSULATION SLEEVING, ELECTRICAL TEFTW22-4 (81851)	FT	REF											
P-H	5950-683-3461	COIL, RADIO FREQUENCY 18-184 (09250)	EA	REF				*	*	*	*		3-12	1A4A2L3	
P-H	5960-230-5226	ELECTRON TUBE 5636 (82219)	EA	2				*	*	*	*		3-12	1A4A2V3	
P-H	5960-230-5226	ELECTRON TUBE 5636 (82219)	EA	REF				*	*	*	*		3-12	1A4A2V4	
M-H		WIRE, ELECTRICAL 00702-1322 (70567)	FT	REF											
M-H		CABLE, RADIO FREQUENCY RG187AU (80058)	FT	REF											
P-H	5950-683-7977	TRANSFORMER RADIO FREQUENCY 544-9788-003 (13499)	EA	1				*	*	*	*		3-12	1A4A2T1	
P-H	5999-795-7293	PRINTED CIRCUIT BOARD 544-2618-003 (13499)	EA	1				*	*	*	*		3-12	1A4A2TB2	
P-H		TERMINAL, STUD 542-4091-002 (13499)	EA	REF				*	*	*	*				
XI-H		EYELET, METALLIC A25 HOTTINNED (57771)	EA	REF											
XI-H		TUBELET 542-0810-003 (13499)	EA	REF											
XI-H		PRINTED CIRCUIT BOARD 544-2617-004 (13499)	EA	1											
P-H		TERMINAL, STUD 542-4085-002 (13499)	EA	REF				*	*	*	*				
P-F		TERMINAL, STUD 545-3205-002 (13499)	EA	REF	*	*	*	*	*	*	*				
P-H		TERMINAL, STUD 542-4091-002 (13499)	EA	REF				*	*	*	*				
P-H	5950-626-9995	TOROID ASSEMBLY 543-2510-004 (13499)	EA	1				*	*	*	*		3-12	1A4A2Z1	
P-H	5905-192-3987	RESISTOR, FIXED, COMPOSITION RC20GF104K (81349)	EA	1				*	*	*	*		3-12	1A4A2R16	
P-H	5905-171-2005	RESISTOR, FIXED, COMPOSITION RC20GF471K (81349)	EA	1				*	*	*	*		3-12	1A4A2R18	
P-F	5905-171-2009	RESISTOR, FIXED, COMPOSITION RC20GF222K (81349)	EA	1	*	*	*	*	*	*	*		3-12	1A4A2R20	
P-F	5905-245-0023	RESISTOR, FIXED, COMPOSITION RC20GF682K (81349)	EA	1	*	*	*	*	*	*	*		3-12	1A4A2R21	
P-H	5905-195-6758	RESISTOR, FIXED, COMPOSITION RC20CF273K (81349)	EA	1				*	*	*	*		3-12	1A4A2R17	
P-H	5910-832-5724	CAPACITOR, FIXED, MICA DIELECTRIC 22H5Q68EG (14655)	EA	1				*	*	*	*		3-12	1A4A2C22	
P-H	5910-678-5079	CAPACITOR, FIXED, MICA DIELECTRIC 22H5Q1CJ (14655)	EA	1				*	*	*	*		3-12	1A4A2C24	
M-H		INSULATION SLEEVING, ELECTRICAL 152-1722-000 (13499)	FT	1											
P-H	5910-984-8375	CAPACITOR, FIXED, MICA DIELECTRIC 22H5T11EJ (14655)	EA	REF				*	*	*	*		3-12	1A4A2C18	

SECTION III REPAIR PART FOR DIRECT SUPPORT, GENERAL SUPPORT, AND DEPOT MAINTENANCE (CONTINUED)

(1) SAC CODE	(2) FEDERAL STOCK NUMBER	(3) DESCRIPTION  USABLE ON CODE	(4) UNIT OF MEAS	(5) QTY INC IN UNIT	(6) 30-DAY DS MAINT ALLOWANCE			(7) 30-DAY GS MAINT ALLOWANCE			(8) 1 YR ALW PER EQUIP CNTYCY	(9) DEPOT MAINT ALW PER 100 EQUIP	(10) ILLUSTRATIONS	
					(a) 1-20	(b) 21-50	(c) 51-100	(a) 1-20	(b) 21-50	(c) 51-100			(a) FIG NO.	(b) ITEM NO. OR REFERENCE DESIGNATION
P-H	5910-581-9801	CAPACITOR, FIXED, MICA DIELECTRIC 22H5T15EJ (14655)	EA	1				*	*	*	*	*	3-12	1A4A2C25
P-H	5910-754-6495	CAPACITOR, VARIABLE VC9GY (73899)	EA	1				*	*	*	*	*	3-12	1A4A2C21
P-H	5910-542-7518	CAPACITOR, FIXED, PAPER DIELECTRIC F107069 (56289)	EA	REF				*	*	*	*	*	3-12	1A4A2C23
P-H	5910-542-7518	CAPACITOR, FIXED, PAPER DIELECTRIC F107069 (56289)	EA	REF				*	*	*	*	*	3-12	1A4A2C29
P-H	5910-542-7518	CAPACITOR, FIXED, PAPER DIELECTRIC F107069 (56289)	EA	REF				*	*	*	*	*	3-12	1A4A2C30
P-H	5910-688-6221	CAPACITOR, FIXED, PAPER DIELECTRIC SDA3K0110M (53021)	EA	1				*	*	*	*	*	3-12	1A4A2C28
P-H	5910-978-6417	CAPACITOR, FIXED, PAPER DIELECTRIC SDA3K0268M (53021)	EA	REF				*	*	*	*	*	3-12	1A4A2C20
P-H	5910-060-9619	CAPACITOR, FIXED, MICA DIELECTRIC 22H5T15EJ (14655)	EA	1				*	*	*	*	*	3-12	1A4A2C32
P-H	5905-190-8879	RESISTOR, FIXED, COMPOSITION RC20GF182K (81349)	EA	1				*	*	*	*	*	3-12	1A4A2R19
P-H	5910-686-9055	CAPACITOR, FIXED, PAPER DIELECTRIC 86F33301S3 (56289)	EA	1				*	*	*	*	*	3-12	1A4A2C19
P-H	5905-752-3157	RESISTOR, FIXED, COMPOSITION RC07GF272K (81349)	EA	1				*	*	*	*	*	3-12	1A4A2R22
P-H	5910-725-1993	CAPACITOR, FIXED, MICA DIELECTRIC 22H5T2EJ (14655)	EA	REF				*	*	*	*	*	3-12	1A4A2C27
P-H	5955-685-8698	CRYSTAL UNIT, QUARTZ S290-7540-000 (01281)	EA	1				*	*	*	*	*	3-12	1A4A2Y1
P-H	5955-6781958	CRYSTAL UNIT, QUARTZ S290-7542-000 (01281)	EA	1				*	*	*	*	*	3-12	1A4A2Y2
P-H	5955-686-7228	CRYSTAL UNIT, QUARTZ S290-7541-000 (01281)	EA	1				*	*	*	*	*	3-12	1A4A2Y3
P-H	5955-686-7230	CRYSTAL UNIT, QUARTZ S290-7543-000 (01281)	EA	1				*	*	*	*	*	3-12	1A4A2Y4
P-H	5910-819-1784	CAPACITOR; SELECT FROM CAPACITOR, FIXED, MICA DIELECTRIC 22H5Q56EJ (14655)	EA	1				*	*	*	*	*	3-12	1A4A2C26
P-H	5910-926-9776	-OR- CAPACITOR, FIXED, MICA DIELECTRIC 22H5Q62EJ (14655)	EA	1				*	*	*	*	*	3-12	1A4A2C26
P-H	5910-837-5677	-OR- CAPACITOR, FIXED, MICA DIELECTRIC DM15FE590G00WV (72136)	EA	1				*	*	*	*	*	3-12	1A4A2C26
XL-H		CLIP, ELECTRICAL 543-2490-002 (13499)	EA	1										
P-H	5905-195-0591	RESISTOR; SELECT FROM RESISTOR, FIXED, COMPOSITION RC20GF102K (81340)	EA	1				*	*	*	*	*	3-12	1A4A2R15
P-H	5905-195-6758	-OR- RESISTOR, FIXED, COMPOSITION RC20GF272K (81349)	EA	1				*	*	*	*	*	3-12	1A4A2R15
P-H	5905-295-3410	-OR- RESISTOR, FIXED, COMPOSITION RC20GF472K (81349)	EA	1				*	*	*	*	*	3-12	1A4A2R15
P-H	5905-106-9345	-OR- RESISTOR, FIXED, COMPOSITION RC20GF683J (81349)	EA	1				*	*	*	*	*	3-12	1A4A2R15
P-H	5905-249-4248	-OR- RESISTOR, FIXED, COMPOSITION RC20GF124K (81349)	EA	1				*	*	*	*	*	3-12	1A4A2R15
P-H	5905-192-0662	-OR- RESISTOR, FIXED, COMPOSITION RC20GF184K (81349)	EA	1				*	*	*	*	*	3-12	1A4A2R15
P-H	5905-141-5416	-OR- RESISTOR, FIXED, COMPOSITION RC20GF274K (81349)	EA	1				*	*	*	*	*	3-12	1A4A2R15



SECTION III REPAIR PART FOR DIRECT SUPPORT, GENERAL SUPPORT, AND DEPOT MAINTENANCE (CONTINUED)

(1) SIR CODE	(2) FEDERAL STOCK NUMBER	(3) DESCRIPTION  USABLE ON CODE	(4) UNIT OF MEAS	(5) QTY INC IN UNIT	(6) 30-DAY DS MAINT ALLOWANCE			(7) 30-DAY GS MAINT ALLOWANCE			(8) 1 YR ALW PER EQUIP CATGCT	(9) DEPOT MAINT ALW PER 100 EQUIP	(10) ILLUSTRATIONS	
					(a) 1-20	(b) 21-50	(c) 51-100	(a) 1-20	(b) 21-50	(c) 51-100			(a) FIG NO.	(b) ITEM NO. OR REFERENCE DESIGNATION
P-H	5905-221-5860	RESISTOR, FIXED, COMPOSITION RC20GF34K (81349) -OR-	EA	1				*	*	*	*	*	3-12	1A4A2R15
P-H	5905-185-6946	RESISTOR, FIXED, COMPOSITION RC20GF74K (81349) -OR-	EA	1				*	*	*	*	*	3-12	1A4A2R15
P-H	5905-141-1073	RESISTOR, FIXED, COMPOSITION RC20GF564K (81349) -OR-	EA	1				*	*	*	*	*	3-12	1A4A2R15
P-H	5905-254-7097	RESISTOR, FIXED, COMPOSITION RC20GF823K (81349) -OR-	EA	1				*	*	*	*	*	3-12	1A4A2R15
P-H	5905-249-4248	RESISTOR, FIXED, COMPOSITION RC20GF333K (81349) -OR-	EA	1				*	*	*	*	*	3-12	1A4A2R15
P-H	5905-190-8879	RESISTOR, FIXED, COMPOSITION RC20GF183K (81349) -OR-	EA	1				*	*	*	*	*	3-12	1A4A2R15
P-H	5905-279-1871	RESISTOR, FIXED, COMPOSITION RC20GF164J (81349) -OR-	EA	1				*	*	*	*	*	3-12	1A4A2R15
P-H	5905-106-9348	RESISTOR, FIXED, COMPOSITION RC20GF154K (81349) -OR-	EA	1				*	*	*	*	*	3-12	1A4A2R15
P-H	5905-121-4953	RESISTOR, FIXED, COMPOSITION RC20GF134J (81349) -OR-	EA	1				*	*	*	*	*	3-12	1A4A2R15
P-H	5905-141-0597	RESISTOR, FIXED, COMPOSITION RC20GF753J (81349) -OR-	EA	1				*	*	*	*	*	3-12	1A4A2R15
P-H	5905-190-8882	RESISTOR, FIXED, COMPOSITION RC20GF393K (81349) -OR-	EA	1				*	*	*	*	*	3-12	1A4A2R15
P-H	5303-616-2568	SCREW, MACHINE P343-0285-000 (77250)	EA	REF				*	*	*	*	*		
X2-H		COVER, SIDE 756-0419-002 (13499)	EA	1										
X2-H		PLATE, COVER 542-7696-003 (13499)	EA	REF										
X2-H		COVER, SIDE 756-0420-002 (13499)	EA	1										
X2-H		PLATE, COVER 542-7696-003 (13499)	EA	REF										
X1-H		INSULATION SLEEVING, ELECTRICAL TEFTW22-6 (81851)	FT	REF										
M-H		WIRE, ELECTRICAL 00702-1322 (70567)	FT	REF										
M-H		INSULATION SLEEVING, ELECTRICAL TEFTW22-2 (81851)	FT	REF										
P-H	5915-863-5932	FILTER, BANDPASS 526-7466-001 (13499)	EA	1				*	*	*	*	*	3-12	1A4A2FL1
P-H		WASHER, FLAT 310-0054-000 (79807)	EA	REF				*	*	*	*	*		
P-F		NUT, PLAIN, HEXAGON P313-0051-000 (77250)	EA	REF	*	*	*	*	*	*	*	*		
P-H		WASHER, LOCK 310-0076-000 (79807)	EA	REF				*	*	*	*	*		
M-H		INSULATOR, FILTER 549-8633-002 (13499)	EA	1										
A-O-1		TUNER, RADIO FREQUENCY 546-2148-005 (13499)	EA	1									3-4	1A4A4
A-F		AMPLIFIER 546-3364-006 (13499)	EA	1										

SECTION III REPAIR PARTS FOR DIRECT SUPPORT, GENERAL SUPPORT,

(1) S/R CODE	(2) FEDERAL STOCK NUMBER	(3) DESCRIPTION  REFERENCE NUMBER & MFR. CODE	(4) UNIT OF MEAS	(5) QTY INC IN UNIT	(6) 30-DAY DS MAINT ALLOWANCE			(7) 30-DAY GS MAINT ALLOWANCE			(8) 1 YR ALW PER EQUIP CATGCT	(9) DEPOT MAINT ALW PER 100 EQUIP	(10) ILLUSTRATIONS	
					(a) 1-20	(b) 21-50	(c) 51-100	(a) 1-20	(b) 21-50	(c) 51-100			(a) FIG NO.	(b) ITEM NO. OR REFERENCE DESIGNATION
P-F	5950-686-6425	COIL, RADIO FREQUENCY BS217 (99800)	EA	6	*	*	*	*	*	*	*	*	3-14	1A4A4L22
P-F	5950-686-6425	COIL, RADIO FREQUENCY BS217 (99800)	EA	REF	*	*	*	*	*	*	*	*	3-14	1A4A4L23
P-F	5950-686-6425	COIL, RADIO FREQUENCY BS217 (99800)	EA	REF	*	*	*	*	*	*	*	*	3-14	1A4A4L24
P-F	5950-686-6425	COIL, RADIO FREQUENCY BS217 (99800)	EA	REF	*	*	*	*	*	*	*	*	3-14	1A4A4L25
P-F	5950-686-6425	COIL, RADIO FREQUENCY BS217 (99800)	EA	REF	*	*	*	*	*	*	*	*	3-14	1A4A4L34
P-F	5910-678-5306	CAPACITOR, FIXED, CERAMIC DIELECTRIC DA049-123B (71590)	EA	26	*	*	*	*	*	*	*	*	3-15	1A4A4C1
P-F	5910-678-5306	CAPACITOR, FIXED, CERAMIC DIELECTRIC DA049-123B (71590)	EA	REF	*	*	*	*	*	*	*	*	3-15	1A4A4C4
P-F	5910-678-5306	CAPACITOR, FIXED, CERAMIC DIELECTRIC DA049-123B (71590)	EA	REF	*	*	*	*	*	*	*	*	3-15	1A4A4C17
P-F	5910-678-5306	CAPACITOR, FIXED, CERAMIC DIELECTRIC DA049-123B (71590)	EA	REF	*	*	*	*	*	*	*	*	3-15	1A4A4C23
P-F	5910-678-5306	CAPACITOR, FIXED, CERAMIC DIELECTRIC DA049-123B (71590)	EA	REF	*	*	*	*	*	*	*	*	3-15	1A4A4C44
P-F	5910-678-5306	CAPACITOR, FIXED, CERAMIC DIELECTRIC DA049-123B (71590)	EA	REF	*	*	*	*	*	*	*	*	3-15	1A4A4C45
P-F	5910-678-5306	CAPACITOR, FIXED, CERAMIC DIELECTRIC DA049-123B (71590)	EA	REF	*	*	*	*	*	*	*	*	3-15	1A4A4C47
P-F	5910-678-5306	CAPACITOR, FIXED, CERAMIC DIELECTRIC DA049-123B (71590)	EA	REF	*	*	*	*	*	*	*	*	3-15	1A4A4C63
P-F	5910-678-5306	CAPACITOR, FIXED, CERAMIC DIELECTRIC DA049-123B (71590)	EA	REF	*	*	*	*	*	*	*	*	3-15	1A4A4C92
P-F	5910-678-5306	CAPACITOR, FIXED, CERAMIC DIELECTRIC DA049-123B (71590)	EA	REF	*	*	*	*	*	*	*	*	3-15	1A4A4C95
P-F	5910-678-5306	CAPACITOR, FIXED, CERAMIC DIELECTRIC DA049-123B (71590)	EA	REF	*	*	*	*	*	*	*	*	3-15	1A4A4C99
P-F	5910-678-5306	CAPACITOR, FIXED, CERAMIC DIELECTRIC DA049-123B (71590)	EA	REF	*	*	*	*	*	*	*	*	3-15	1A4A4C100
P-F	5910-678-5306	CAPACITOR, FIXED, CERAMIC DIELECTRIC DA049-123B (71590)	EA	REF	*	*	*	*	*	*	*	*	3-15	1A4A4C102
P-F	5910-678-5306	CAPACITOR, FIXED, CERAMIC DIELECTRIC DA049-123B (71590)	EA	REF	*	*	*	*	*	*	*	*	3-15	1A4A4C104
P-F	5910-678-5306	CAPACITOR, FIXED, CERAMIC DIELECTRIC DA049-123B (71590)	EA	REF	*	*	*	*	*	*	*	*	3-15	1A4A4C108
P-F	5910-678-5306	CAPACITOR, FIXED, CERAMIC DIELECTRIC DA049-123B (71590)	EA	REF	*	*	*	*	*	*	*	*	3-15	1A4A4C111
P-F	5910-678-5306	CAPACITOR, FIXED, CERAMIC DIELECTRIC DA049-123B (71590)	EA	REF	*	*	*	*	*	*	*	*	3-15	1A4A4C112
P-F	5910-678-5306	CAPACITOR, FIXED, CERAMIC DIELECTRIC DA049-123B (71590)	EA	REF	*	*	*	*	*	*	*	*	3-15	1A4A4C116
P-F	5910-678-5306	CAPACITOR, FIXED, CERAMIC DIELECTRIC DA049-123B (71590)	EA	REF	*	*	*	*	*	*	*	*	3-15	1A4A4C122
P-F	5910-678-5306	CAPACITOR, FIXED, CERAMIC DIELECTRIC DA049-123B (71590)	EA	REF	*	*	*	*	*	*	*	*	3-15	1A4A4C132
P-F	5910-678-5306	CAPACITOR, FIXED, CERAMIC DIELECTRIC DA049-123B (71590)	EA	REF	*	*	*	*	*	*	*	*	3-15	1A4A4C134
P-F	5910-678-5306	CAPACITOR, FIXED, CERAMIC DIELECTRIC DA049-123B (71590)	EA	REF	*	*	*	*	*	*	*	*	3-15	1A4A4C135

SECTION III REPAIR PARTS FOR DIRECT SUPPORT, GENERAL SUPPORT, AND DEPOT MAINTENANCE (CONTINUED)

(1) SHE CODE	(2) FEDERAL STOCK NUMBER	(3) DESCRIPTION  REFERENCE NUMBER & MFR. CODE	(4) UNIT OF MEAS	(5) QTY INC IN UNIT	(6) 30-DAY DS MAINT ALLOWANCE			(7) 30-DAY GS MAINT ALLOWANCE			(8) 1 YR ALW PER EQUIP CATGRY	(9) DEPOT MAINT ALW PER 100 EQUIP	(10) ILLUSTRATIONS	
					(a) 1-20	(b) 21-50	(c) 51-100	(a) 1-20	(b) 21-50	(c) 51-100			(a) FIG NO.	(b) ITEM NO. OR REFERENCE DESIGNATION
P-F	5910-678-5306	CAPACITOR, FIXED, CERAMIC DIELECTRIC DA049-123B (71590)	EA	REF	*	*	*	*	*	*	*	*	3-15	1A4A4C142
P-F	5910-678-5306	CAPACITOR, FIXED, CERAMIC DIELECTRIC DA049-123B (71590)	EA	REF	*	*	*	*	*	*	*	*	3-15	1A4A4C174
P-F	5910-678-5306	CAPACITOR, FIXED, CERAMIC DIELECTRIC DA049-123B (71590)	EA	REF	*	*	*	*	*	*	*	*	3-15	1A4A4C179
P-F	5910-678-5306	CAPACITOR, FIXED, CERAMIC DIELECTRIC DA049-123B (71590)	EA	REF	*	*	*	*	*	*	*	*		1A4A4C183
P-F	5905-195-6806	RESISTOR, FIXED, COMPOSITION RC20GF102K (81349)	EA	3	*	*	*	*	*	*	*	*	3-14	1A4A4R1
P-F	5905-195-6806	RESISTOR, FIXED, COMPOSITION RC20GF102K (81349)	EA	REF	*	*	*	*	*	*	*	*	3-14	1A4A4R2
P-F	5905-195-6806	RESISTOR, FIXED, COMPOSITION RC20GF102K (81349)	EA	REF	*	*	*	*	*	*	*	*	3-14	1A4A4R11
P-F	5905-195-6806	RESISTOR, FIXED, COMPOSITION RC20GF102K (81349)	EA	REF	*	*	*	*	*	*	*	*	3-14	1A4A4R12
P-F	5905-195-6806	RESISTOR, FIXED, COMPOSITION RC20GF102K (81349)	EA	REF	*	*	*	*	*	*	*	*	3-14	1A4A4R17
P-F	5905-195-6806	RESISTOR, FIXED, COMPOSITION RC20GF102K (81349)	EA	REF	*	*	*	*	*	*	*	*	3-14	1A4A4R25
P-F	5905-195-6806	RESISTOR, FIXED, COMPOSITION RC20GF102K (81349)	EA	REF	*	*	*	*	*	*	*	*	3-14	1A4A4R40
P-F	5905-195-6806	RESISTOR, FIXED, COMPOSITION RC20GF102K (81349)	EA	REF	*	*	*	*	*	*	*	*	3-14	1A4A4R56
P-H	5905-190-8879	RESISTOR, FIXED, COMPOSITION RC20GF183K (81349)	EA	3	*	*	*	*	*	*	*	*	3-14	1A4A4R7
P-H	5905-190-8879	RESISTOR, FIXED, COMPOSITION RC20GF183K (81349)	EA	REF	*	*	*	*	*	*	*	*	3-14	1A4A4R18
P-H	5905-190-8879	RESISTOR, FIXED, COMPOSITION RC20GF183K (81349)	EA	REF	*	*	*	*	*	*	*	*	3-14	1A4A4R26
P-F	5910-666-7905	CAPACITOR, FIXED, MICA DIELECTRIC VOM5ELLIG (72136)	EA	1	*	*	*	*	*	*	*	*	3-15	1A4A4C11
P-F	5910-766-8790	CAPACITOR, FIXED, MICA DIELECTRIC 22H5T13EG (14655)	EA	6	*	*	*	*	*	*	*	*	3-15	1A4A4C121
P-F	5910-766-8790	CAPACITOR, FIXED, MICA DIELECTRIC 22H5T13EG (14655)	EA	REF	*	*	*	*	*	*	*	*	3-15	1A4A4C180
P-F	5905-192-0390	RESISTOR, FIXED, COMPOSITION RC20GF105K (81349)	EA	1	*	*	*	*	*	*	*	*	3-14	1A4A4R34
P-H	5905-106-9348	RESISTOR, FIXED, COMPOSITION RC20GF154K (81349)	EA	1	*	*	*	*	*	*	*	*	3-14	1A4A4R35
P-F	5910-666-7228	CAPACITOR, FIXED, CERAMIC DIELECTRIC BB61-102T66X (71590)	EA	2	*	*	*	*	*	*	*	*	3-15	1A4A4C61
P-F	5910-666-7228	CAPACITOR, FIXED, CERAMIC DIELECTRIC BB61-102T66X (71590)	EA	REF	*	*	*	*	*	*	*	*	3-15	1A4A4C109
P-H	5905-141-0591	RESISTOR, FIXED, COMPOSITION RC20GF474K (81349)	EA	6	*	*	*	*	*	*	*	*	3-14	1A4A4R3
P-H	5905-141-0591	RESISTOR, FIXED, COMPOSITION RC20GF474K (81349)	EA	REF	*	*	*	*	*	*	*	*	3-14	1A4A4R8
P-H	5905-141-0591	RESISTOR, FIXED, COMPOSITION RC20GF474K (81349)	EA	REF	*	*	*	*	*	*	*	*	3-14	1A4A4R10
P-H	5905-141-0591	RESISTOR, FIXED, COMPOSITION RC20GF474K (81349)	EA	REF	*	*	*	*	*	*	*	*	3-14	1A4A4R23
P-H	5905-141-0591	RESISTOR, FIXED, COMPOSITION RC20GF474K (81349)	EA	REF	*	*	*	*	*	*	*	*	3-14	1A4A4R31

SECTION III REPAIR PARTS FOR DIRECT SUPPORT, GENERAL SUPPORT, AND DEPOT MAINTENANCE (CONTINUED)

(1) SNR CODE	(2) FEDERAL STOCK NUMBER	(3) DESCRIPTION  REFERENCE NUMBER & MFR. CODE	(4) UNIT OF MEAS	(5) QTY INC IN UNIT	(6) 30-DAY DS MAINT ALLOWANCE			(7) 30-DAY GS MAINT ALLOWANCE			(8) 1 YR ALW PER EQUIP CNTGCT	(9) DEPOT MAINT ALW PER 100 EQUIP	(10) ILLUSTRATIONS	
					(a)	(b)	(c)	(a)	(b)	(c)			(a)	(b)
					1-20	21-50	51-100	1-20	21-50	51-100			FIG NO.	ITEM NO. OR REFERENCE DESIGNATION
P-H	5905-141-0591	RESISTOR, FIXED, COMPOSITION RC20GF474K (81349)	EA	REF				*	*	*	*	*	3-14	1A4A4R37
P-H	5905-192-3987	RESISTOR, FIXED, COMPOSITION RC20GF104K (81349)	EA	5				*	*	*	*	*	3-14	1A4A4R19
P-H	5905-192-3987	RESISTOR, FIXED, COMPOSITION RC20GF104K (81349)	EA	REF				*	*	*	*	*	3-14	1A4A4R21
P-H	5905-192-3987	RESISTOR, FIXED, COMPOSITION RC20GF104K (81349)	EA	REF				*	*	*	*	*	3-14	1A4A4R24
P-H	5905-193-3987	RESISTOR, FIXED, COMPOSITION RC20GF104K (81349)	EA	REF				*	*	*	*	*	3-14	1A4A4R27
P-H	5905-192-3987	RESISTOR, FIXED, COMPOSITION RC20GF104K (81349)	EA	REF				*	*	*	*	*	3-14	1A4A4R32
P-F	5905-279-2529	RESISTOR, FIXED, COMPOSITION RC42GF222K (81349)	EA	3	*	*	*	*	*	*	*	*	3-14	1A4A4R5
P-F	5905-279-2529	RESISTOR, FIXED, COMPOSITION RC42GF222K (81349)	EA	REF	*	*	*	*	*	*	*	*	3-14	1A4A4R20
P-F	5905-279-2529	RESISTOR, FIXED, COMPOSITION RC42GF222K (81349)	EA	REF	*	*	*	*	*	*	*	*	3-14	1A4A4R33
P-F	5910-824-9417	CAPACITOR, FIXED, CERAMIC DIELECTRIC GA3-00UFP0R05PCT (78488)	EA	1	*	*	*	*	*	*	*	*	3-15	1A4A4C27
P-F	5905-141-0591	RESISTOR, FIXED, COMPOSITION RC20GF103K (81349)	EA	2	*	*	*	*	*	*	*	*	3-14	1A4A4R29
P-F	5905-141-0591	RESISTOR, FIXED, COMPOSITION RC20GF103K (81349)	EA	REF	*	*	*	*	*	*	*	*	3-14	1A4A4R36
P-F	5905-185-6966	RESISTOR, FIXED, COMPOSITION RC20GF271K (81349)	EA	1	*	*	*	*	*	*	*	*	3-14	1A4A4R38
P-H	5903-106-1282	RESISTOR, FIXED, COMPOSITION RC20GF223K (81349)	EA	1	*	*	*	*	*	*	*	*	3-14	1A4A4R55
P-F	5905-473-5251	RESISTOR, FIXED, COMPOSITION RC32GF102K (81349)	EA	1	*	*	*	*	*	*	*	*	3-14	1A4A4R6
P-H	5905-252-5428	RESISTOR, FIXED, COMPOSITION RC20GF680K (81349)	EA	5	*	*	*	*	*	*	*	*	3-14	1A4A4R9
P-H	5905-252-5428	RESISTOR, FIXED, COMPOSITION RC20GF680K (81349)	EA	REF	*	*	*	*	*	*	*	*	3-14	1A4A4R15
P-H	5905-252-5428	RESISTOR, FIXED, COMPOSITION RC20GF680K (81349)	EA	REF	*	*	*	*	*	*	*	*	3-14	1A4A4R22
P-H	5905-252-5428	RESISTOR, FIXED, COMPOSITION RC20GF680K (81349)	EA	REF	*	*	*	*	*	*	*	*	3-14	1A4A4R30
P-H	5905-252-5428	RESISTOR, FIXED, COMPOSITION RC20GF680K (81349)	EA	REF	*	*	*	*	*	*	*	*	3-14	1A4A4R62
P-F	5905-279-1869	RESISTOR, FIXED, COMPOSITION RC20GF121K (81349)	EA	1	*	*	*	*	*	*	*	*	3-14	1A4A4R4
P-F	5905-106-9347	RESISTOR, FIXED, COMPOSITION RC20GF335K (81349)	EA	1	*	*	*	*	*	*	*	*	3-14	1A4A4R60
P-F	5910-824-8236	CAPACITOR, FIXED, CERAMIC DIELECTRIC GA2-00UFP0R05PCT (78488)	EA	3	*	*	*	*	*	*	*	*	3-15	1A4A4C139
P-F	5910-824-8236	CAPACITOR, FIXED, CERAMIC DIELECTRIC GA2-00UFP0R05PCT (78488)	EA	REF	*	*	*	*	*	*	*	*	3-15	1A4A4C144
P-F	5910-824-8236	CAPACITOR, FIXED, CERAMIC DIELECTRIC GA2-00UFP0R05PCT (78488)	EA	REF	*	*	*	*	*	*	*	*	3-15	1A4A4C145
P-H	5910-663-4759	CAPACITOR, FIXED, MICA DIELECTRIC 22H5Q2CJ (14655)	EA	3	*	*	*	*	*	*	*	*	3-15	1A4A4C13
P-H	5910-663-4759	CAPACITOR, FIXED, MICA DIELECTRIC 22H5Q2CJ (14655)	EA	REF	*	*	*	*	*	*	*	*	3-15	1A4A4C194

SECTION III REPAIR PARTS FOR DIRECT SUPPORT, GENERAL SUPPORT, AND MAINTENANCE (CONTINUED)

(1) SIB CODE	(2) FEDERAL STOCK NUMBER	(3) DESCRIPTION  REFERENCE NUMBER & MFR. CODE	(4) UNIT OF MEAS	(5) QTY INC IN UNIT	(6) 30-DAY DS MAINT ALLOWANCE			(7) 30-DAY GS MAINT ALLOWANCE			(8) 1 YR ALW PER EQUIP CATEG	(9) DEPOT MAINT ALW PER 100 EQUIP	(10) ILLUSTRATIONS	
					(a) 1-20	(b) 21-50	(c) 51-100	(a) 1-20	(b) 21-50	(c) 51-100			(a) FIG NO.	(b) ITEM NO. OR REFERENCE DESIGNATION
P-H	5910-663-4759	CAPACITOR, FIXED, MICA DIELECTRIC 22H5Q2CJ (14655)	EA	REF				*	*	*	*	*		1A4A4C185
P-F	5910-823-1308	CAPACITOR, FIXED, MICA DIELECTRIC 22H5Q2CJ (14655)	EA	1	*	*	*	*	*	*	*	*	3-15	1A4A4C18
P-F	5910-993-2380	CAPACITOR, FIXED, MICA DIELECTRIC 22H5Q12CJ (14655)	EA	2	*	*	*	*	*	*	*	*	3-15	1A4A4C46
P-F	5910-893-8953	CAPACITOR, FIXED, CERAMIC DIELECTRIC GAL-0UUFPRM5PCT (78488)	EA	3	*	*	*	*	*	*	*	*	3-15	1A4A4C32
P-F	5910-893-8953	CAPACITOR, FIXED, CERAMIC DIELECTRIC GAL-0UUFPRM5PCT (78488)	EA	REF	*	*	*	*	*	*	*	*	3-15	1A4A4C37
P-F	5910-819-8244	CAPACITOR, FIXED, CERAMIC DIELECTRIC GAL-5UUFPRM5PCT (78488)	EA	2	*	*	*	*	*	*	*	*	3-15	1A4A4C66
P-F	5910-819-8244	CAPACITOR, FIXED, CERAMIC DIELECTRIC GAL-5UUFPRM5PCT (78488)	EA	REF	*	*	*	*	*	*	*	*	3-15	1A4A4C70
P-H		RESISTOR, FIXED, COMPOSITION RC20GF100J (81349)	EA	1	*	*	*	*	*	*	*	*	3-14	1A4A4B57
P-H	5905-171-2002	RESISTOR, FIXED, COMPOSITION RC20GF470K (81349)	EA	1	*	*	*	*	*	*	*	*	3-14	1A4A4R13
P-F	5905-249-4217	RESISTOR, FIXED, COMPOSITION RC42GF153K (81349)	EA	2	*	*	*	*	*	*	*	*	3-14	1A4A4R16
P-F	5905-249-4217	RESISTOR, FIXED, COMPOSITION RC42GF153K (81349)	EA	REF	*	*	*	*	*	*	*	*		1A4A4R65
P-F	5910-679-9397	CAPACITOR, FIXED, PAPER DIELECTRIC 931-6541-000 (00656)	EA	1	*	*	*	*	*	*	*	*	3-15	1A4A4C74
M-H		CABLE, RADIO FREQUENCY RC196AU (80058)	FT	REF										
M-H		WIRE, ELECTRICAL WTE734ACW0 (90484)	FT	REF										
M-H		WIRE, ELECTRICAL WTE734ACW1 (90484)	FT	REF										
M-H		WIRE, ELECTRICAL WTE734ACW2 (90484)	FT	4										
M-H		WIRE, ELECTRICAL WTE734ACW3 (90484)	FT	3										
M-H		WIRE, ELECTRICAL WTE734ACW5 (90484)	FT	7										
M-H		WIRE, ELECTRICAL WTE734ACW6 (90484)	FT	5										
M-H		WIRE, ELECTRICAL MILW16878TYPE22-0 (81349)	FT	4										
M-H		WIRE, ELECTRICAL WTE734ACW9 (90484)	FT	2										
M-H		WIRE, ELECTRICAL WTE734ACW90 (90484)	FT	3										
M-H		WIRE, ELECTRICAL WTE734ACW91 (90484)	FT	REF										
M-H		WIRE, ELECTRICAL WTE734ACW92 (90484)	FT	REF										
M-H		WIRE, ELECTRICAL WTE734ACW93 (90484)	FT	2										
M-H		WIRE, ELECTRICAL WTE734ACW95 (90484)	FT	2										
M-H		WIRE, ELECTRICAL WTE734ACW96 (90484)	FT	3										

SECTION II REPAIR PARTS FOR DIRECT SUPPORT, GENERAL SUPPORT AND DEPOT MAINTENANCE (CONTINUED)

SIR CODE	FEDERAL STOCK NUMBER	DESCRIPTION REFERENCE NUMBER & MFR. CODE	USABLE ON CODE	UNIT OF MEAS	QTY INC IN UNIT	30-DAY DS MAINT ALLOWANCE			30-DAY GS MAINT ALLOWANCE			1 YR ALM PER EQUIP CNTGCTY	DEPOT MAINT ALM PER 100 EQUIP	ILLUSTRATIONS		
						(a)	(b)	(c)	(a)	(b)	(c)			(a)	(b)	
						1-20	21-50	51-100	1-20	21-50	51-100			FIG NO.	ITEM NO. OR REFERENCE DESIGNATION	
M-H		WIRE, ELECTRICAL WTE73ACW902 (90484)		FT	4											
P-H		TERMINAL, LUG SP14040-4HOTTINNED (77147)		EA	12	*	*	*	*	*	*	*	*			
M-H		WIRE, ELECTRICAL WTE73ACW905 (90484)		FT	2											
M-H		WIRE, ELECTRICAL WTE73ACW906 (90484)		FT	1											
M-H		WIRE, ELECTRICAL WTE73ACW912 (90484)		FT	4											
M-H		WIRE, ELECTRICAL WTE73ACW913 (90484)		FT	3											
M-H		WIRE, ELECTRICAL WTE73ACW915 (90484)		FT	1											
M-H		WIRE, ELECTRICAL WTE73ACW916 (90484)		FT	REF											
M-H		WIRE, ELECTRICAL WTE73ACW923 (90484)		FT	2											
M-H		WIRE, ELECTRICAL WTE73ACW925 (90484)		FT	REF											
M-H		WIRE, ELECTRICAL WTE73ACW926 (90484)		FT	REF											
M-H		WIRE, ELECTRICAL WTE73ACW935 (90484)		FT	2											
M-H		WIRE, ELECTRICAL WTE73ACW936 (90484)		FT	3											
M-H		WIRE, ELECTRICAL WTE73ACW956 (90484)		FT	1											
P-F	5305-054-5646	SCREW, MACHINE MS51957-12 (96906)		EA	REF	*	*	*	*	*	*	*	*			
P-F	5305-777-6039	SCREW, MACHINE MS51959-12 (96906)		EA	REF	*	*	*	*	*	*	*	*			
P-F		NUT, PLAIN, HEXAGON P313-0132-000 (77250)		EA	REF	*	*	*	*	*	*	*	*			
P-F	5310-058-2949	WASHER, LOCK MS535337-78 (96906)		EA	REF	*	*	*	*	*	*	*	*			
P-F	5935-222-9828	SOCKET, ELECTRON TUBE 7490-0191 (94991)		EA	3	*	*	*	*	*	*	*	*	3-16	1A4A4XV1	
P-F	5935-222-9828	SOCKET, ELECTRON TUBE 7490-0191 (94991)		EA	REF	*	*	*	*	*	*	*	*	3-16	1A4A4XV3	
P-F	5935-222-9828	SOCKET, ELECTRON TUBE 7490-0191 (94991)		EA	REF	*	*	*	*	*	*	*	*	3-16	1A4A4XV6	
P-F	m-054-5647	SCREW, MACHINE MS51957-13 (96906)		EA	REF	*	*	*	*	*	*	*	*			
P-H		TERMINAL, LUG T957HOTTINNED (79963)		EA	8	*	*	*	*	*	*	*	*			
P-H	5950-594-1217	COIL, RADIO FREQUENCY 18-124 (09250)		EA	1	*	*	*	*	*	*	*	*		1A4A4L33	
P-F	5305-054-5637	SCREW, MACHINE MS51957-3 (96906)		EA	REF	*	*	*	*	*	*	*	*			
P-F	310-271-4640	NUT, PLAIN, HEXAGON MS35649-24 (96906)		EA	REF	*	*	*	*	*	*	*	*			
P-H		TERMINAL, LUG 601 (79963)		EA	21	*	*	*	*	*	*	*	*			

SECTION III REPAIR PARTS FOR DIRECT SUPPORT, GENERAL SUPPORT AND DEPOT MAINTENANCE (CONTINUED)

(1) S/R CODE	(2) FEDERAL STOCK NUMBER	(3) DESCRIPTION  REFERENCE NUMBER & MFR. CODE	(4) UNIT OF MEAS	(5) QTY INC IN UNIT	(6) 30-DAY DS MAINT ALLOWANCE			(7) 30-DAY GS MAINT ALLOWANCE			(8) 1 YR ALW PER EQUIP CNTGCT	(9) DEPOT MAINT ALW PER 100 EQUIP	(10) ILLUSTRATIONS	
					(a) 1-20	(b) 21-50	(c) 51-100	(a) 1-20	(b) 21-50	(c) 51-100			(a) FIG NO.	(b) ITEM NO. OR REFERENCE DESIGNATION
P-H		TERMINAL, LIG 2104-04-01-2520N (78189)	EA	41				*	*	*	*			
P-F	5310-058-3829	WASHER, LOCK MS35338-77 (96906)	EA	REF	*	*	*	*	*	*	*			
P-H	5305-054-5653	SCREW, MACHINE MS51957-19 (96906)	EA	6				*	*	*	*			
P-F	5935-961-5106	SOCKET, ELECTRON 7470-0231 (94991)	EA	7	*	*	*	*	*	*	*	3-16	1A4A4XV2	
P-F	5935-961-5106	SOCKET, ELECTRON 7470-0231 (94991)	EA	REF	*	*	*	*	*	*	*	3-16	1A4A4XV4	
P-F	5935-961-5106	SOCKET, ELECTRON 7470-0231 (94991)	EA	REF	*	*	*	*	*	*	*	3-16	1A4A4XV5	
P-F	5935-961-5106	SOCKET, ELECTRON 7470-0231 (94991)	EA	REF	*	*	*	*	*	*	*	3-16	1A4A4XV7	
P-F	5935-961-5106	SOCKET, ELECTRON 7470-0231 (94991)	EA	REF	*	*	*	*	*	*	*	3-16	1A4A4XV8	
P-F	5935-961-5106	SOCKET, ELECTRON 7470-0231 (94991)	EA	REF	*	*	*	*	*	*	*	3-16	1A4A4XV9	
P-F	5935-961-5106	SOCKET, ELECTRON 7470-0231 (94991)	EA	REF	*	*	*	*	*	*	*	3-16	1A4A4XV10	
P-F	945-577-7273	RELAY, ARMATURE 515951 (44038)	EA	1	*	*	*	*	*	*	*	3-14	1A4A4K1	
P-F	305-054-5651	SCREW, MACHINE MS51957-17 (96906)	EA	REF	*	*	*	*	*	*	*			
P-F	821-657-0429	BUTTON, STAKED 541-5177-002 (13499)	EA	REF	*	*	*	*	*	*	*			
P-H	5305-054-5636	SCREW, MACHINE MS51957-2 (96906)	EA	REF				*	*	*	*			
P-F	5910-893-8875	CAPACITOR, FIXED, PAPER DIELECTRIC 186P10404S15 (56289)	EA	2	*	*	*	*	*	*	*	3-15	1A4A4C75	
P-F	5910-893-8875	CAPACITOR, FIXED, PAPER DIELECTRIC 186P10404S15 (56289)	EA	REF	*	*	*	*	*	*	*	3-15	1A4A4C76	
P-F		NUT, PLAIN, HEXAGON P334-0254-000 (77250)	EA	REF	*	*	*	*	*	*	*			
P-F		WASHER, LOCK 1218-02CADPL (78189)	EA	REF	*	*	*	*	*	*	*			
X2-H		SHIELD, ELECTRICAL 544-2566-003 (13499)	EA	1										
X2-H		SHIELD, ELECTRICAL 544-2565-003 (13499)	EA	1										
P-F	5940-782-8942	TERMINAL, FEEDTHRU FTSM1 (98291)	EA	REF	*	*	*	*	*	*	*			
X2-H		EYELET, METALLIC A1444HOTFINNED (57771)	EA	3										
P-F	5305-054-5648	SCREW, MACHINE MS51957-14 (96906)	EA	REF	*	*	*	*	*	*	*			
P-H	305-054-5638	SCREW, MACHINE MS51957-4 (96906)	EA	2				*	*	*	*			
P-H	5310-614-3500	NUT, SELF-LOCKING, HEXAGON 68-1660-40 (72962)	EA	REF				*	*	*	*			
X2-H		BAR, STIFFENING 543-2969-003 (13499)	EA	1										
X2-H		BAR-CASTING 543-2969-013 (13499)	EA	1										

SECTION REPAIR PARTS FOR DIRECT SUPPORT, GENERAL SUPPORT, AND DEPOT MAINTENANCE (CONTINUED)

(1) SNR CODE	(2) FEDERAL STOCK NUMBER	(3) DESCRIPTION  REFERENCE NUMBER & MFR. CODE	(4) UNIT OF MEAS	(5) QTY INC IN UNIT	(6) 30-DAY DS MAINT ALLOWANCE			(7) 30-DAY GS MAINT ALLOWANCE			(8) 1 YR ALW PER EQUIP CNTGCT	(9) DEPOT MAINT ALW PER 100 EQUIP	(10) ILLUSTRATIONS		
					USABLE ON CODE	(a)	(b)	(c)	(a)	(b)			(c)	(a) FIG NO.	(b) ITEM NO. OR REFERENCE DESIGNATION
						1-20	21-50	51-100	1-20	21-50			51-100		
X2-H		BAR, STIFFENING 543-2970-003 (13499)	EA	1											
X2-H		BAR-CASTING 543-2970-013 (13499)	EA	1											
P-F	5921-615-4986	AMPLIFIER, SUBASSEMBLY-SWITCH 543-2931-002 (13499)	EA	1	*	*	*	*	*	*	*				
X1-F		SWITCH, ROTARY 543-2862-002 (13499)	EA	1								3-14	1A4A4S10		
X2-F	5325-073-1172	EYELET, METALLIC SE25CADPL (90030)	EA	REF											
X1-F		EYELET, METALLIC 542-0810-003 (13499)	EA	REF											
X1-F		SWITCH, ROTARY 542-4119-002 (13499)	EA	1											
X1-F		ROTOR, ELECTRICAL 543-2871-002 (13499)	EA	10											
X1-F		RETAINER, ROTOR 543-2872-002 (13499)	EA	14											
X1-F		BLADE, CONTACT 543-2873-002 (13499)	EA	12											
X1-F		CONTACT, ELECTRICAL 31-242-0057 (37942)	EA	34											
X1-F		BLADE, ELECTRICAL 543-2874-002 (13499)	EA	12											
X1-F		BLADE, CONTACT 543-2875-002 (13499)	EA	12											
X1-F		CONTACT, ELECTRICAL 31-242-0057 (37942)	EA	REF											
X1-F		BLADE, ELECTRICAL 543-2876-002 (13499)	EA	12											
P-F	5950-686-6425	COIL, RADIO FREQUENCY RS217 (99800)	EA	REF	*	*	*	*	*	*	*	3-14	1A4A4L21		
P-F	5821-615-4987	AMPLIFIER, SUBASSEMBLY-SWITCH 543-2934-002 (13499)	EA	1	*	*	*	*	*	*	*	3-14	1A4A4S14		
X1-F		SWITCH, ROTARY 543-2869-002 (13499)	EA	1											
X2-F	5325-073-1172	EYELET, METALLIC SE25CADPL (90030)	EA	REF											
X1-F		EYELET, METALLIC 542-0810-003 (13499)	EA	REF											
X2-F		EYELET, METALLIC 542-0811-003 (13499)	EA	REF											
X1-F		SWITCH, ROTARY 542-4126-003 (13499)	EA	1											
X1-F		ROTOR, ELECTRICAL 543-2871-002 (13499)	EA	REF											
X1-F		BLADE, CONTACT 543-2877-002 (13499)	EA	5											
X1-F		CONTACT, ELECTRICAL 31-242-0057 (37942)	EA	REF											
X1-F		BLADE, ELECTRICAL 543-2878-002 (13499)	EA	5											
X1-F		RETAINER, ROTOR 543-2872-002 (13499)	EA	REF											



SECTION III REPAIR PARTS FOR DIRECT SUPPORT, GENERAL SUPPORT, AND DEPOT MAINTENANCE (CONTINUED)

(1) SR CODE	(2) FEDERAL STOCK NUMBER	(3) DESCRIPTION  USABLE ON CODE	(4) UNIT OF MEAS	(5) QTY INC IN UNIT	(6) 30-DAY DS MAINT ALLOWANCE			(7) 30-DAY GS MAINT ALLOWANCE			(8) 1 YR ALW PER EQUIP CNTGTY	(9) DEPOT MAINT ALW PER 100 EQUIP	(10) ILLUSTRATIONS	
					(a) 1-20	(b) 21-50	(c) 51-100	(a) 1-20	(b) 21-50	(c) 51-100			(a) FIG NO.	(b) ITEM NO. OR REFERENCE DESIGNATION
P-F	5905-257-0926	RESISTOR, FIXED, COMPOSITION RC20GF332K (81349)	EA	1	*	*	*	*	*	*	*	3-14	1A4A4R39	
P-F	5910-984-5253	CAPACITOR, FIXED, MICA DIELECTRIC 22H5T33EG (14655)	EA	3	*	*	*	*	*	*	*	3-15	1A4A4C177	
P-F	5910-663-5572	CAPACITOR, FIXED, MICA DIELECTRIC 22H5T39EG (14655)	EA	1	*	*	*	*	*	*	*	3-15	1A4A4C178	
P-F	5820-447-9919	AMPLIFIER, SUBASSEMBLY-SWITCH 543-9071-002 (13499)	EA	1	*	*	*	*	*	*	*	3-14	1A4A4S15	
P-H	5905-141-0595	RESISTOR, FIXED, COMPOSITION RC20GF472K (81349)	EA	1	*	*	*	*	*	*	*		1A4A4R66	
P-F	5850-701-5926	COIL, RADIO FREQUENCY LT4K040 (81349)	EA	1	*	*	*	*	*	*	*		1A4A4L36	
P-F	5910-988-7897	CAPACITOR, FIXED, MICA DIELECTRIC 22H5Q33DG (14655)	EA	2	*	*	*	*	*	*	*		1A4A4C186	
XI-F		SWITCH, ROTARY 543-2870-002 (13499)	EA	1										
X2-F	5325-073-1172	EYELET, METALLIC SE25CAEPL (90030)	EA	REF										
XI-F		TUBELET 542-0810-003 (13499)	EA	REF										
XI-F		SWITCH, ROTARY 542-4127-002 (13499)	EA	1										
XI-F		ROTOR, ELECTRICAL 543-2871-002 (13499)	EA	REF										
XI-F		BLADE, CONTACT 543-2877-002 (13499)	EA	REF										
XI-F		CONTACT, ELECTRICAL 31-242-0057 (37942)	EA	REF										
XI-F		BLADE, ELECTRICAL 543-2878-002 (13499)	EA	REF										
P-F		WASHER 543-2921-002 (13499)	EA	3	*	*	*	*	*	*	*			
P-F	5821-615-4985	AMPLIFIER, SUBASSEMBLY-SWITCH 543-2933-002 (13499)	EA	1	*	*	*	*	*	*	*	3-14	1A4A4S2	
XI-F		SWITCH, ROTARY 543-2867-002 (13499)	EA	1										
X2-F	5325-073-1172	EYELET, METALLIC SE25CAEPL (90030)	EA	REF										
XI-F		EYELET, METALLIC 542-0810-003 (13499)	EA	REF										
XI-F		SWITCH, ROTARY 542-4124-002 (13499)	EA	1										
XI-F		ROTOR, ELECTRICAL 543-2871-002 (13499)	EA	REF										
XI-F		RETAINER, ROTOR 543-2872-002 (13499)	EA	REF										
XI-F		BLADE, CONTACT 543-2873-002 (13499)	EA	REF										
XI-F		CONTACT, ELECTRICAL 31-242-0057 (37942)	EA	REF										
XI-F		BLADE, ELECTRICAL 543-2874-002 (13499)	EA	REF										
XI-F		BLADE, CONTACT 543-2875-002 (13499)	EA	REF										

SECTION III REPAIR PARTS FOR DIRECT SUPPORT, GENERAL SUPPORT, AND DEPOT MAINTENANCE

(1) S/R CODE	(2) FEDERAL STOCK NUMBER	(3) DESCRIPTION  REFERENCE NUMBER & MFR. CODE	(4) UNIT OF MEAS	(5) QTY INC IN UNIT	(6) 30-DAY DS MAINT ALLOWANCE			(7) 30-DAY GS MAINT ALLOWANCE			(8) 1 YR ALW PER EQUIP CNTGCTY	(9) DEPOT MAINT ALW PER 100 EQUIP	(10) ILLUSTRATIONS	
					(a) 1-20	(b) 21-50	(c) 51-100	(a) 1-20	(b) 21-50	(c) 51-100			(a) FIG NO.	(b) ITEM NO. OR REFERENCE DESIGNATION
XI-F		CONTACT, ELECTRICAL 31-242-0057 (37942)	EA	REF										
XI-F		BLADE, ELECTRICAL 543-2876-002 (13499)	EA	REF										
P-F	5910-543-9552	CAPACITOR, VARIABLE 55701BCOP039R (72982)	EA	1	*	*	*	*	*	*	*	*	3-15	1A4A4C25
P-F	5305-054-5644	SCREW, MACHINE MS51957-11 (96906)	EA	REF	*	*	*	*	*	*	*	*		
P-F	5305-054-5648	SCREW, MACHINE MS51957-14 (96906)	EA	REF	*	*	*	*	*	*	*	*		
P-F		NUT, PLAIN, HEXAGON P313-0132-000 (77250)	EA	REF	*	*	*	*	*	*	*	*		
XI-F		RETAINER, CAPACITOR 544-6096-002 (13499)	EA	1										
M-H		WIRE, ELECTRICAL 00702-1326 (70567)	FT	REF										
P-F	5921-615-4988	AMPLIFIER, ASSEMBLY SWITCH 543-2932-002 (13499)	EA	1	*	*	*	*	*	*	*	*		
XI-F		SWITCH, ROTARY 543-2866-002 (13499)	EA	1									3-14	1A4A4S4
X2-F	5325-073-1172	EYELET, METALLIC SE25CADPL (90030)	EA	REF										
XI-F		EYELET, METALLIC 542-0810-003 (13499)	EA	REF										
X2-F		EYELET, METALLIC 542-0811-003 (13499)	EA	REF										
XI-F		SWITCH, SECTION 542-4123-002 (13499)	EA	1										
XI-F		ROTOR, ELECTRICAL 543-2871-002 (13499)	EA	REF										
XI-F		RETAINER, ROTOR 543-2872-002 (13499)	EA	REF										
XI-F		BLADE, CONTACT 543-2873-002 (13499)	EA	REF										
XI-F		CONTACT, ELECTRICAL 31-242-0057 (37942)	EA	REF										
XI-F		BLADE, ELECTRICAL 543-2874-002 (13499)	EA	REF										
XI-F		BLADE, CONTACT 543-2875-002 (13499)	EA	REF										
XI-F		CONTACT ELECTRICAL 31-242-0057 (37942)	EA	REF										
XI-F		BLADE, ELECTRICAL 543-2876-002 (13499)	EA	REF										
P-F	5905-171-2527	RESISTOR, FIXED, COMPOSITION RC42GF392K (81349)	EA	1	*	*	*	*	*	*	*	*	3-14	1A4A4R28
P-F	5910-893-8953	CAPACITOR, FIXED CERAMIC DIELECTRIC GAL-00UFPORM5PCT (78488)	EA	REF	*	*	*	*	*	*	*	*	3-15	1A4A4C38
P-F	5930-679-9411	SWITCH, ROTARY 543-2865-002 (13499)	EA	1	*	*	*	*	*	*	*	*	3-14	1A4A4S6
X2-F	5325-073-1172	EYELET, METALLIC SE25CADPL (90030)	EA	REF										
XI-F		EYELET, METALLIC 542-0810-003 (13499)	EA	REF										

SECTION III REPAIR PARTS FOR DIRECT SUPPORT, GENERAL SUPPORT, AND DEPOT MAINTENANCE (CONTINUED)

(1) SIR CODE	(2) FEDERAL STOCK NUMBER	(3) DESCRIPTION  REFERENCE NUMBER & MFR. CODE	(4) UNIT OF MEAS	(5) QTY INC IN UNIT	(6) 30-DAY DS MAINT ALLOWANCE			(7) 30-DAY GS MAINT ALLOWANCE			(8) 1 YR ALW PER EQUIP CNTGCT	(9) DEPOT MAINT ALW PER 100 EQUIP	(10) ILLUSTRATIONS	
					(a)	(b)	(c)	(a)	(b)	(c)			(a)	(b)
					1-20	21-50	51-100	1-20	21-50	51-100			FIG NO.	ITEM NO. OR REFERENCE DESIGNATION
X1-F		ROTOR, ELECTRICAL 543-2871-002 (13499)	EA	REF										
X1-F		RETAINER, ROTOR 543-2872-002 (13499)	EA	REF										
X1-F		BLADE, CONTACT 543-2873-002 (13499)	EA	REF										
X1-F		CONTACT, ELECTRICAL 31-242-0057 (37942)	EA	REF										
X1-F		BLADE, ELECTRICAL 543-2874-002 (13499)	EA	REF										
X1-F		BLADE, CONTACT 543-2875-002 (13499)	EA	REF										
X1-F		CONTACT, ELECTRICAL 31-242-0057 (37942)	EA	REF										
X1-F		BLADE, ELECTRICAL 543-2876-002 (13499)	EA	REF										
X1-F		SWITCH, ROTARY 542-4122-002 (13499)	EA	1										
P-F	5930-629-8335	SWITCH, ROTARY 543-2864-002 (13499)	EA	1	*	*	*	*	*	*	*	*	3-14	1A4A4S8
X2-F	5325-073-1172	EYELET, METALLIC SE25CADPL (90030)	EA	REF										
X1-F		EYELET, METALLIC 542-0810-003 (13499)	EA	REF										
X1-F		SWITCH, ROTARY 542-4121-002 (13499)	EA	1										
X1-F		ROTOR, ELECTRICAL 543-2871-002 (13499)	EA	REF										
X1-F		BLADE, CONTACT 543-2877-002 (13499)	EA	REF										
X1-F		CONTACT, ELECTRICAL 31-242-0057 (37942)	EA	REF										
X1-F		BLADE, ELECTRICAL 543-2878-002 (13499)	EA	REF										
P-F		WASHER 543-2921-002 (13499)	EA	REF	*	*	*	*	*	*	*	*		
P-F	5930-679-9411	SWITCH, ROTARY 543-2863-002 (13499)	EA	1	*	*	*	*	*	*	*	*	3-14	1A4A4S9
X2-F	5325-073-1172	EYELET, METALLIC SE25CADPL (90030)	EA	REF										
X1-F		EYELET, METALLIC 542-0810-003 (13499)	EA	REF										
X2-F		SWITCH, ROTARY 542-4120-002 (13499)	EA	1										
X1-F		ROTOR, ELECTRICAL 543-2871-002 (13499)	EA	REF										
X1-F		BLADE, CONTACT 543-2877-002 (13499)	EA	REF										
X1-F		CONTACT, ELECTRICAL 31-242-0057 (37942)	EA	REF										
X1-F		BLADE, ELECTRICAL 543-2878-002 (13499)	EA	REF										
P-F		WASHER 543-2921-002 (13499)	EA	REF	*	*	*	*	*	*	*	*		

SECTION III REPAIR PARTS FOR DIRECT SUPPORT, GENERAL SUPPORT, AND DEPOT MAINTENANCE (CONTINUED)

(1) S/R CODE	(2) FEDERAL STOCK NUMBER	(3) DESCRIPTION  REFERENCE NUMBER & MFR. CODE	(4) UNIT OF MEAS	(5) QTY INC IN UNIT	(6) 30-DAY DS MAINT ALLOWANCE			(7) 30-DAY GS MAINT ALLOWANCE			(8) 1 YR ALN PER EQUIP CNTGCT	(9) DEPOT MAINT ALN PER 100 EQUIP	(10) ILLUSTRATIONS	
					(a) 1-20	(b) 21-50	(c) 51-100	(a) 1-20	(b) 21-50	(c) 51-100			(a) FIG NO.	(b) ITEM NO. OR REFERENCE DESIGNATION
X2-F		BRACKET, MOUNTING 543-2918-002 (13499)	EA	1										
P-F	5930-629-8339	SWITCH, ROTARY 543-2920-002 (13499)	EA	1	*	*	*	*	*	*	*	*	3-14	1A4A4S1
X2-F	5325-073-1172	EYELET, METALLIC SE25CADPL (90030)	EA	REF										
X1-F		EYELET, METALLIC 542-0810-003 (13499)	EA	REF										
X1-F		ROTOR, ELECTRICAL 543-2871-002 (13499)	EA	REF										
X1-F		RETAINER, ROTOR 543-2872-002 (13499)	EA	REF										
X1-F		BLADE, CONTACT 543-2873-002 (13499)	EA	REF										
X1-F		CONTACT, ELECTRICAL 31-242-0057 (37942)	EA	REF										
X1-F		BLADE, ELECTRICAL 543-2874-002 (13499)	EA	REF										
X1-F		BLADE, CONTACT 543-2875-002 (13499)	EA	REF										
X1-F		CONTACT, ELECTRICAL 31-242-0057 (37942)	EA	REF										
X1-F		BLADE, ELECTRICAL 543-2876-002 (13499)	EA	REF										
X1-F		SWITCH, ROTARY 542-4128-003 (13499)	EA	1										
P-F	5930-629-8337	SWITCH, ROTARY 543-2868-002 (13499)	EA	1	*	*	*	*	*	*	*	*	3-14	1A4A4S12
X2-F	5325-073-1172	EYELET, METALLIC SE25CADPL (90030)	EA	REF										
X1-F		EYELET, METALLIC 542-0810-003 (13499)	EA	REF										
X1-F		SWITCH, ROTARY 542-4125-002 (13499)	EA	1										
X1-F		ROTOR, ELECTRICAL 543-2871-002 (13499)	EA	REF										
X1-F		RETAINER-ROTOR 543-2872-002 (13499)	EA	REF										
X1-F		BLADE, CONTACT 543-2873-002 (13499)	EA	REF										
X1-F		CONTACT, ELECTRICAL 31-242-0057 (37942)	EA	REF										
X1-F		BLADE, ELECTRICAL 543-2874-002 (13499)	EA	REF										
X1-F		BLADE, CONTACT 543-2875-002 (13499)	EA	REF										
X1-F		CONTACT, ELECTRICAL 31-242-0057 (37942)	EA	REF										
X1-F		BLADE, ELECTRICAL 543-2876-002 (13499)	EA	REF										
A-F		CHASSIS, RADIO FREQUENCY TUNER 544-2772-004 (13499)	EA	1										
X2-F		RIVET, TUBULAR R3484X3-32CADPL (12014)	EA	10										

SECTION III REPAIR PARTS FOR DIRECT SUPPORT, GENERAL SUPPORT, AND DEPOT MAINTENANCE (CONTINUED)

(1) SIR CODE	(2) FEDERAL STOCK NUMBER	(3) DESCRIPTION  REFERENCE NUMBER & MFR. CODE	(4) UNIT OF MEAS	(5) QTY INC IN UNIT	(6) 30-DAY DS MAINT ALLOWANCE			(7) 30-DAY GS MAINT ALLOWANCE			(8) 1 YR ALW PER EQUIP CNTGCT	(9) DEPOT MAINT ALW PER 100 EQUIP	(10) ILLUSTRATIONS	
					(a) 1-20	(b) 21-50	(c) 51-100	(a) 1-20	(b) 21-50	(c) 51-100			(a) FIG NO.	(b) ITEM NO. OR REFERENCE DESIGNATION
X2-F	5320-117-6010	RIVET, SOLID MS2026AD2-3 (96906)	EA	REF										
P-F		TERMINAL, STUD 1985 (12615)	EA	REF	*	*	*	*	*	*	*	*		
X1-F		EYELET, METALLIC SE33CADPL (90030)	EA	28										
P-F	5935-538-3069	JACK, TIP SKT1 (98291)	EA	1	*	*	*	*	*	*	*	*	3-14	1A4A4E22
P-F	5935-615-8555	JACK, TIP SKT9BCWHT (98291)	EA	14	*	*	*	*	*	*	*	*	3-14	1A4A4J1
P-F	5935-615-8555	JACK, TIP SKT9BCWHT (98291)	EA	REF	*	*	*	*	*	*	*	*	3-14	1A4A4J3
P-F	5935-615-8555	JACK, TIP SKT9BCWHT (98291)	EA	REF	*	*	*	*	*	*	*	*		1A4A4J16
P-F	5935-615-8555	JACK, TIP SKT9BCWHT (98291)	EA	REF	*	*	*	*	*	*	*	*	3-14	1A4A4J10
P-F	5935-615-8555	JACK, TIP SKT9BCWHT (98291)	EA	REF	*	*	*	*	*	*	*	*	3-14	1A4A4J9
P-F	5935-615-8555	JACK, TIP SKT9BCWHT (98291)	EA	REF	*	*	*	*	*	*	*	*	3-14	1A4A4J14
P-F	5935-615-8555	JACK, TIP SKT9BCWHT (98291)	EA	REF	*	*	*	*	*	*	*	*	3-14	1A4A4J15
P-F	5935-615-8555	JACK, TIP SKT9BCWHT (98291)	EA	REF	*	*	*	*	*	*	*	*	3-14	1A4A4J12
P-F	5935-615-8555	JACK, TIP SKT9BCWHT (98291)	EA	REF	*	*	*	*	*	*	*	*	3-14	1A4A4J5
P-F	5935-615-8555	JACK, TIP SKT9BCWHT (98291)	EA	REF	*	*	*	*	*	*	*	*	3-14	1A4A4J11
P-F	5935-615-8555	JACK, TIP SKT9BCWHT (98291)	EA	REF	*	*	*	*	*	*	*	*	3-14	1A4A4J6
P-F	5935-615-8555	JACK, TIP SKT9BCWHT (98291)	EA	REF	*	*	*	*	*	*	*	*	3-14	1A4A4J13
P-F	5935-615-8555	JACK, TIP SKT9BCWHT (98291)	EA	REF	*	*	*	*	*	*	*	*	3-14	1A4A4J7
P-F	5935-615-8555	JACK, TIP SKT9BCWHT (98291)	EA	REF	*	*	*	*	*	*	*	*	3-14	1A4A4J8
P-F		NUT, CAPTIVE 543-0435-002 (13499)	EA	39	*	*	*	*	*	*	*	*		
X2-F		BRACKET, MOUNTING 543-2911-002 (13499)	EA	14										
X2-F		BRACKET, MOUNTING 543-2912-002 (13499)	EA	2										
X2-F		BRACKET, MOUNTING 543-2913-002 (13499)	EA	1										
X2-F		BRACKET, MOUNTING 543-2914-002 (13499)	EA	1										
P-F		SEIM BRACKET 543-2923-002 (13499)	EA	3	*	*	*	*	*	*	*	*		
P-H		BRACKET, RETAINER 542-7768-002 (13499)	EA	REF				*	*	*	*	*		
X2-F		CHASSIS, ELECTRICAL 544-2774-005 (13499)	EA	1										
X1-F		EYELET, METALLIC SE43HOTTINDED (61957)	EA	8										

SECTION III REPAIR PARTS FOR DIRECT SUPPORT, GENERAL SUPPORT AND DEPOT MAINTENANCE (CONTINUED)

(1) SMR CODE	(2) FEDERAL STOCK NUMBER	(3) DESCRIPTION  USABLE ON CODE	(4) UNIT OF MEAS	(5) QTY INC IN UNIT	(6) 30-DAY DS MAINT ALLOWANCE			(7) 30-DAY GS MAINT ALLOWANCE			(8) 1 YR ALW PER EQUIP CNTGCT	(9) DEPOT MAINT ALW PER 100 EQUIP	(10) ILLUSTRATIONS	
					(a)	(b)	(c)	(a)	(b)	(c)			(a)	(b)
					1-20	21-50	51-100	1-20	21-50	51-100			FIG NO.	ITEM NO. OR REFERENCE DESIGNATION
P-F		TERMINAL, STUD 26-134 (12615)	EA	5	*	*	*	*	*	*	*			
P-F	5940-782-8942	TERMINAL, FEEDTHRU FTSML (98291)	EA	REF	*	*	*	*	*	*	*			
P-F		TERMINAL, STUD 2619A (12615)	EA	REF	*	*	*	*	*	*	*			
P-F	5310-814-3459	NUT, PLAIN, CLINGHED SN440-1 (56878)	EA	5	*	*	*	*	*	*	*			
P-F		NUT, PLAIN, CLINGHED S440-0C (46384)	EA	43	*	*	*	*	*	*	*			
X1-F		EYELET, METALLIC SE34CADPL (90030)	EA	16										
X2-F		BRACKET, MOTOR 543-2905-002 (13499)	EA	1										
P-F		NUT, CAPTIVE NCN4-1-2 (07886)	EA	REF	*	*	*	*	*	*	*			
X2-F		BRACKET, MOTOR 543-2906-002 (13499)	EA	1										
A-F		MOTOR, SWITCH 548-1280-002 (13499)	EA	1										
P-F	6105-679-9396	MOTOR, DIRECT CURRENT 43A159 (25140)	EA	1	*	*	*	*	*	*	*	3-14	1A4A4B1	
P-F	5315-058-9698	PIN, SPRING MS16562-191 (96906)	EA	1	*	*	*	*	*	*	*			
P-F	6105-956-3435	SLEEVE, MOTOR 548-1279-002 (13499)	EA	1	*	*	*	*	*	*	*			
A-H		BRACKET, FILTER 543-3018-005 (13499)	EA	1										
P-F		INSULATION SLEEVING, ELECTRICAL TEFTW22B (81851)	FT	REF	*	*	*	*	*	*	*			
P-F		TERMINAL, LUG SPL40402HOT TINNED (77147)	EA	REF	*	*	*	*	*	*	*			
P-F	5310-058-2949	WASHER, LOCK MS535337-78 (96906)	EA	REF	*	*	*	*	*	*	*			
P-F		NUT, PLAIN, HEXAGON P313-0132-000 (77250)	EA	REF	*	*	*	*	*	*	*			
P-F	5305-770-2533	SCREW, MACHINE MS51959-2 (96906)	EA	REF	*	*	*	*	*	*	*			
X2-F		STRIP, SPACING 543-2919-002 (13499)	EA	1										
P-H	5310-559-7792	WASHER, LOCK AN936B4B (88044)	EA	49				*	*	*	*			
X2-H		BRACKET, FILTER 543-2903-002 (13499)	EA	1										
P-H		WASHER, FLAT 310-0055-000 (79807)	EA	3				*	*	*	*			
P-H		PIN, LOCATING 540-7767-002 (13499)	EA	2				*	*	*	*			
X2-H		BRACKET, FILTER 543-3014-004 (13499)	EA	1										
P-F	5940-782-8942	TERMINAL, FEEDTHRU FTSML (98291)	EA	REF	*	*	*	*	*	*	*			
P-F		TERMINAL, STUD 2619A (12615)	EA	REF	*	*	*	*	*	*	*			

SECTION III REPAIR PARTS FOR DIRECT SUPPORT, GENERAL SUPPORT, AND DEPOT. MAINTENANCE (CONTINUED)

(1) SNR CODE	(2) FEDERAL STOCK NUMBER	(3) DESCRIPTION  REFERENCE NUMBER & MFR. CODE	(4) UNIT OF MEAS	(5) QTY INC IN UNIT	(6) 30-DAY DS MAINT ALLOWANCE			(7) 30-DAY GS MAINT ALLOWANCE			(8) 1 YR ALW PER EQUIP CNTGTY	(9) DEPOT MAINT ALW PER 100 EQUIP	(10) ILLUSTRATIONS	
					(a) 1-20	(b) 21-50	(c) 51-100	(a) 1-20	(b) 21-50	(c) 51-100			(a) FIG NO.	(b) ITEM NO. OR REFERENCE DESIGNATION
XI-F		EYELET, METALLIC SE43HOTFINNED (61957)	EA	REF										
P-F	5310-824-3459	NUT, PLAIN, CLINCHED SN440-1 (56878)	EA	REF	*	*	*	*	*	*	*			
P-H	5905-279-2658	RESISTOR, FIXED, COMPOSITION RC20GF820K (81349)	EA	1				*	*	*	*	3-14	1A4A4R59	
P-H	5910-667-8866	CAPACITOR, FIXED, CERAMIC DIELECTRIC 2856005X5U0102P (72982)	EA	29				*	*	*	*	3-15	1A4A4C67	
P-H	5910-667-8866	CAPACITOR, FIXED, CERAMIC DIELECTRIC 2856005X5U0102P (72982)	EA	REF				*	*	*	*	3-15	1A4A4C90	
P-H	5910-667-8866	CAPACITOR, FIXED, CERAMIC DIELECTRIC 2856005X5U0102P (72982)	EA	REF				*	*	*	*	3-15	1A4A4C96	
P-H	5910-667-8866	CAPACITOR, FIXED, CERAMIC DIELECTRIC 2856005X5U0102P (72982)	EA	REF				*	*	*	*	3-15	1A4A4C97	
P-H	5910-667-8866	CAPACITOR, FIXED, CERAMIC DIELECTRIC 2856005X5U0102P (72982)	EA	REF				*	*	*	*	3-15	1A4A4C98	
P-H	5910-667-8866	CAPACITOR, FIXED, CERAMIC DIELECTRIC 2856005X5U0102P (72982)	EA	REF				*	*	*	*	3-15	1A4A4C101	
P-H	5910-667-8866	CAPACITOR, FIXED, CERAMIC DIELECTRIC 2856005X5U0102P (72982)	EA	REF				*	*	*	*		1A4A4C103	
P-H	5910-667-8866	CAPACITOR, FIXED, CERAMIC DIELECTRIC 2856005X5U0102P (72982)	EA	REF				*	*	*	*	3-15	1A4A4C106	
P-H	5910-667-8866	CAPACITOR, FIXED, CERAMIC DIELECTRIC 2856005X5U0102P (72982)	EA	REF				*	*	*	*	3-15	1A4A4C107	
P-H	5910-667-8866	CAPACITOR, FIXED, CERAMIC DIELECTRIC 2856005X5U0102P (72982)	EA	REF				*	*	*	*	3-15	1A4A4C110	
P-H	5910-667-8866	CAPACITOR, FIXED, CERAMIC DIELECTRIC 2856005X5U0102P (72982)	EA	REF				*	*	*	*	3-15	1A4A4C115	
P-H	5910-667-8866	CAPACITOR, FIXED, CERAMIC DIELECTRIC 2856005X5U0102P (72982)	EA	REF				*	*	*	*	3-15	1A4A4C116	
P-H	5910-667-8866	CAPACITOR, FIXED, CERAMIC DIELECTRIC 2856005X5U0102P (72982)	EA	REF				*	*	*	*	3-15	1A4A4C117	
P-H	5910-667-8866	CAPACITOR, FIXED, CERAMIC DIELECTRIC 2856005X5U0102P (72982)	EA	REF				*	*	*	*	3-15	1A4A4C123	
P-H	5910-667-8866	CAPACITOR, FIXED, CERAMIC DIELECTRIC 2856005X5U0102P (72982)	EA	REF				*	*	*	*	3-15	1A4A4C133	
P-H	5910-667-8866	CAPACITOR, FIXED, CERAMIC DIELECTRIC 2856005X5U0102P (72982)	EA	REF				*	*	*	*	3-15	1A4A4 159	
P-H	5910-667-8866	CAPACITOR, FIXED, CERAMIC DIELECTRIC 2856005X5U0102P (72982)	EA	REF				*	*	*	*	3-15	1A4A4C160	
P-H	5910-667-8866	CAPACITOR, FIXED, CERAMIC DIELECTRIC 2856005X5U0102P (72982)	EA	REF				*	*	*	*	3-15	1A4A4C161	
P-H	5910-667-8866	CAPACITOR, FIXED, CERAMIC DIELECTRIC 2856005X5U0102P (72982)	EA	REF				*	*	*	*	3-15	1A4A4C162	
P-H	5910-667-8866	CAPACITOR, FIXED, CERAMIC DIELECTRIC 2856005X5U0102P (72982)	EA	REF				*	*	*	*	3-15	1A4A4C163	
P-H	5910-667-8866	CAPACITOR, FIXED, CERAMIC DIELECTRIC 2856005X5U0102P (72982)	EA	REF				*	*	*	*	3-15	1A4A4C164	
P-H	5910-667-8866	CAPACITOR, FIXED, CERAMIC DIELECTRIC 2856005X5U0102P (72982)	EA	REF				*	*	*	*	3-15	1A4A4C165	
P-H	5910-667-8866	CAPACITOR, FIXED, CERAMIC DIELECTRIC 2856005X5U0102P (72982)	EA	REF				*	*	*	*	3-15	1A4A4C166	
P-H	5910-667-8866	CAPACITOR, FIXED, CERAMIC DIELECTRIC 2856005X5U0102P (72982)	EA	REF				*	*	*	*	3-15	1A4A4C167	

SECTION III REPAIR PARTS FOR DIRECT SUPPORT, GENERAL SUPPORT, AND DEPOT MAINTENANCE

(1) SMR CODE	(2) FEDERAL STOCK NUMBER	(3) DESCRIPTION  REFERENCE NUMBER & MFR. CODE	(4) UNIT OF MEAS	(5) QTY INC IN UNIT	(6) 30-DAY DS MAINT ALLOWANCE			(7) 30-DAY GS MAINT ALLOWANCE			(8) 1 YR ALM PER EQUIP CNTGCT	(9) DEPOT MAINT ALM PER 100 EQUIP	(10) ILLUSTRATIONS	
					(a)	(b)	(c)	(a)	(b)	(c)			(a)	(b)
					1-20	21-50	51-100	1-20	21-50	51-100			FIG NO.	ITEM NO. OR REFERENCE DESIGNATION
P-H	5910-667-8866	CAPACITOR, FIXED, CERAMIC DIELECTRIC 2856005X5U0102P (72982)	EA	REF				*	*	*	*	*	3-15	1A4A4C168
P-H	5910-667-8866	CAPACITOR, FIXED, CERAMIC DIELECTRIC 2856005X5U0102P (72982)	EA	REF				*	*	*	*	*	3-15	1A4A4C169
P-H	5910-667-8866	CAPACITOR, FIXED, CERAMIC DIELECTRIC 2856005X5U0102P (72982)	EA	REF				*	*	*	*	*	3-15	1A4A4C172
P-H	5910-667-8866	CAPACITOR, FIXED, CERAMIC DIELECTRIC 2856005X5U0102P (72982)	EA	REF				*	*	*	*	*	3-15	1A4A4C173
P-H	5910-667-8866	CAPACITOR, FIXED, CERAMIC DIELECTRIC 2856005X5U0102P (72982)	EA	REF				*	*	*	*	*	3-15	1A4A4C175
P-H	5935-057-7591	CONNECTOR, RECEPTACLE, ELECTRICAL DC37F10 (71789)	EA	1				*	*	*	*	*	3-14	1A4A4P2
P-H	5935-057-2690	CONNECTOR, RECEPTACLE, ELECTRICAL DA15P (71468)	EA	4				*	*	*	*	*	3-14	1A4A4P1
M-H		WIRE, ELECTRICAL WTE734ACW1 (90484)	FT	REF										
M-H		WIRE, ELECTRICAL WTE734ACW3 (90484)	FT	REF										
M-H		WIRE, ELECTRICAL WTE734ACW5 (90484)	FT	REF										
M-H		WIRE, ELECTRICAL WTE734ACW6 (90484)	FT	REF										
M-H		WIRE, ELECTRICAL WTE734ACW0 (90484)	FT	REF										
M-H		WIRE, ELECTRICAL WTE2736AD (90484)	FT	2										
M-H		WIRE, ELECTRICAL WTE734ACW92 (90484)	FT	REF										
M-H		WIRE, ELECTRICAL WTE734ACW93 (90484)	FT	REF										
M-H		WIRE, ELECTRICAL WTE734ACW95 (90484)	FT	REF										
M-H		WIRE, ELECTRICAL WTE734ACW96 (90484)	FT	REF										
M-H		WIRE, ELECTRICAL WTE734ACW90 (90484)	FT	REF										
M-H		WIRE, ELECTRICAL WTE734ACW91 (90484)	FT	REF										
M-H		WIRE, ELECTRICAL WTE734ACW912 (90484)	FT	REF										
M-H		WIRE, ELECTRICAL WTE734ACW902 (90484)	FT	REF										
M-H		WIRE, ELECTRICAL WTE734ACW905 (90484)	FT	REF										
M-H		WIRE, ELECTRICAL WTE734ACW913 (90484)	FT	REF										
M-H		WIRE, ELECTRICAL WTE734ACW923 (90484)	FT	REF										
M-H		WIRE, ELECTRICAL WTE734ACW926 (90484)	FT	REF										
M-H		WIRE, ELECTRICAL WTE734ACW935 (90484)	FT	REF										
M-H		WIRE, ELECTRICAL WTE734ACW936 (90484)	FT	REF										



SECTION III REPAIR PARTS FOR DIRECT SUPPORT, GENERAL SUPPORT AND DEPOT MAINTENANCE (CONTINUED)

(1) SR CODE	(2) FEDERAL STOCK NUMBER	(3) DESCRIPTION  REFERENCE NUMBER & MFR. CODE	(4) UNIT OF MEAS	(5) QTY INC IN UNIT	(6) 30-DAY DS MAINT ALLOWANCE			(7) 30-DAY GS MAINT ALLOWANCE			(8) 1 YR ALW PER EQUIP CMTGTY	(9) DEPOT MAINT ALW PER 100 EQUIP	(10) ILLUSTRATIONS	
					(a) 1-20	(b) 21-50	(c) 51-100	(a) 1-20	(b) 21-50	(c) 51-100			(a) FIG NO.	(b) ITEM NO. OR REFERENCE DESIGNATION
M-H		WIRE, ELECTRICAL 00702-1326 (70567)	FT	REF										
M-H		CABLE, RADIO FREQUENCY RG196AU (80058)	FT	REF										
M-H		WIRE, ELECTRICAL MILW16878TYPE22-90 (81349)	FT	REF										
M-H		WIRE, ELECTRICAL MILW16878TYPE22-91 (81349)	FT	REF										
M-H		WIRE, ELECTRICAL WTE734ACW903 (90484)	FT	REF										
P-F	5905-879-0596	RESISTOR, FIXED, WIRE WOUND CSR7W4000-5 (00213)	EA	1	*	*	*	*	*	*	*	*		1A4A4R67
P-H	5961-866-0476	SEMICONDUCTOR DEVICE, DIODE 1N457 (07688)	EA	2				*	*	*	*	*		1A4A4CR2
P-H	5961-866-0476	SEMICONDUCTOR DEVICE, DIODE 1N457 (07688)	EA	REF				*	*	*	*	*		1A4A4CR3
A-H		TRANSFORMER 543-2929-002 (13499)	EA	1									3-14	1A4A4T2
P-H	5950-810-5556	TRANSFORMER, INTERMEDIATE FREQUENCY X092-2 (81815)	EA	1				*	*	*	*	*		1A4A4T2A
X2-H		PLATE, MOUNTING, COIL 543-2928-002 (13499)	EA	2										
A-H		TRANSFORMER 543-2930-002 (13499)	EA	1									3-14	1A4A4T1
P-H	5950-752-4278	TRANSFORMER, INTERMEDIATE FREQUENCY X093-1 (81815)	EA	1				*	*	*	*	*		1A4A4T2
X2-H		PLATE, MOUNTING COIL 543-2928-002 (13499)	EA	REF										
X1-H		TUBE INSERT 543-2935-002 (13499)	EA	7										
X2-H		HOSE, METAL 543-2915-002 (13499)	EA	1										
M-H		WIRE, ELECTRICAL 00702-1322 (70567)	FT	REF										
M-H		WIRE, ELECTRICAL 00702-1320 (70567)	FT	REF										
M-H		WIRE, ELECTRICAL 00702-1326 (70567)	FT	REF										
M-H		INSULATION SLEEVING, ELECTRICAL TEFTW26B (81851)	FT	500										
P-F		INSULATION SLEEVING, ELECTRICAL TEFTW22B (81851)	FT	REF	*	*	*	*	*	*	*	*		
M-H		INSULATION SLEEVING, ELECTRICAL TEFTW20B (81851)	FT	REF										
P-F	5905-279-3527	RESISTOR, FIXED, COMPOSITION RC42GF470K (81349)	EA	1	*	*	*	*	*	*	*	*	3-14	1A4A4R63
P-F	5910-613-4414	CAPACITOR, FIXED, CERAMIC DIELECTRIC GA2-4UUFPOEM5PCT (78488)	EA	1	*	*	*	*	*	*	*	*	3-15	1A4A4C146
P-F		SCREW, MACHINE P347-0007-000 (77250)	EA	REF	*	*	*	*	*	*	*	*		
M-H		INSULATION SLEEVING, ELECTRICAL FLEXITEFLON6B (03890)	FT	3										
X2-H		PLATE, TAPPED 544-7290-002 (13499)	EA	1										

SECTION III REPAIR PARTS FOR DIRECT SUPPORT, GENERAL SUPPORT, AND DEPOT MAINTENANCE (CONTINUED)

(1) SIR CODE	(2) FEDERAL STOCK NUMBER	(3) DESCRIPTION  REFERENCE NUMBER & MFR. CODE	(4) UNIT OF MEAS	(5) QTY INC IN UNIT	(6) 30-DAY DS MAINT ALLOWANCE			(7) 30-DAY GS MAINT ALLOWANCE			(8) 1 YR ALLOW EQUIP CNTGCT	(9) DEPOT MAINT ALLOW PER 100 EQUIP	(10) ILLUSTRATIONS	
					(a) 1-20	(b) 21-50	(c) 51-100	(a) 1-20	(b) 21-50	(c) 51-100			(a) FIG NO.	(b) ITEM NO. OR REFERENCE DESIGNATION
X2-H		PLATE, TAPPED 544-912G-002 (13499)	EA	1										
M-H		INSULATION SLEEVING, ELECTRICAL MIL13190CLB1SIZE9-0 (81349)	FT	1										
P-F	:5310-595-5421	WASHER, FLAT 310-632G-000 (79807)	EA	REF	*	*	*	*	*	*	*			
P-H	:5910-678-5079	CAPACITOR, FIXED, MICA DIELECTRIC 22H5W1CJ (14655)	EA	1				*	*	*	*	3-15	1A4A4062	
P-F	:5950-826-0179	COIL, RADIO FREQUENCY 4422-11-117 (82142)	EA	2	*	*	*	*	*	*	*			1A4A4135
P-F	:5950-826-0179	COIL, RADIO FREQUENCY 4422-11-117 (82142)	EA	REF	*	*	*	*	*	*	*			1A4A4137
P-F	:5910-850-0541	CAPACITOR, FIXED, MICA DIELECTRIC 22H5Q43DG (14655)	EA	2	*	*	*	*	*	*	*	3-15	1A4A4C12	
P-F	:5910-988-4718	CAPACITOR, FIXED, CERAMIC DIELECTRIC GA5-9UUFFORM5PCT (78488)	EA	1	*	*	*	*	*	*	*			1A4A4C184
P-F	:5910-683-7478	CAPACITOR, FIXED, MICA DIELECTRIC 22H5T3EG (14655)	EA	1	*	*	*	*	*	*	*	3-15	1A4A4C26	
P-F	:5910-679-1993	CAPACITOR, FIXED, CERAMIC DIELECTRIC GA3-9UUFFORM5PCT (78488)	EA	4	*	*	*	*	*	*	*	3-15	1A4A4C5	
P-F	:5910-679-1993	CAPACITOR, FIXED, CERAMIC DIELECTRIC GA3-9UUFFORM5PCT (78488)	EA	REF	*	*	*	*	*	*	*	3-15	1A4A4C8	
P-F	:5910-679-1993	CAPACITOR, FIXED, CERAMIC DIELECTRIC GA3-9UUFFORM5PCT (78488)	EA	REF	*	*	*	*	*	*	*	3-15	1A4A4C15	
P-F	:5910-679-1993	CAPACITOR, FIXED, CERAMIC DIELECTRIC GA3-9UUFFORM5PCT (78488)	EA	REF	*	*	*	*	*	*	*	3-15	1A4A4C21	
P-F		HEXAGONAL, STUD 2A1DB12 (92825)	EA	REF	*	*	*	*	*	*	*			
P-F		STUD, CONTINUOUS THREAD P312-3460-000 (77250)	EA	1	*	*	*	*	*	*	*			
P-F	:5910-936-7370	CAPACITOR, FIXED, MICA DIELECTRIC 22H5Q36DG (14655)	EA	2	*	*	*	*	*	*	*	3-15	1A4A4C93	
A-F		PLATE, GEAR 543-3012-004 (13499)	EA	1										
X2-F		PLATE, GEAR 543-3013-004 (13499)	EA	1										
P-F		POST, IDLER 543-2883-002 (13499)	EA	3	*	*	*	*	*	*	*			
X2-F		PLATE, GEAR 543-2957-003 (13499)	EA	1										
X2-F		PLATE, GEAR 543-3009-004 (13499)	EA	1										
P-H		POST, IDLER 543-2889-002 (13499)	EA	3				*	*	*	*			
P-H	:3020-684-2152	IDLER, SMALL 543-2880-002 (13499)	EA	4				*	*	*	*	3-16	1A4A4MP1	
P-H	:3020-684-2152	IDLER, SMALL 543-2880-002 (13499)	EA	REF				*	*	*	*	3-16	1A4A4MP2	
P-H	:3020-684-2152	IDLER, SMALL 543-2880-002 (13499)	EA	REF				*	*	*	*	3-16	1A4A4MP3	
P-H	:3020-684-2152	IDLER, SMALL 543-2880-002 (13499)	EA	REF				*	*	*	*	3-16	1A4A4MP4	
X1-H		BEARING, ROLLER GB47M11G3278 (60380)	EA	6										

SECTION III REPAIR PARTS FOR DIRECT SUPPORT, GENERAL SUPPORT, AND DEPOT MAINTENANCE (CONTINUED)

(1) S/R CODE	(2) FEDERAL STOCK NUMBER	(3) DESCRIPTION  REFERENCE NUMBER & MFR. CODE	(4) UNIT OF MEAS	(5) QTY INC IN UNIT	(6) 30-DAY GS MAINT ALLOWANCE			(7) 30-DAY GS MAINT ALLOWANCE			(8) 1 YR ALW PER EQUIP CNTGCTY	(9) DEPOT MAINT ALW PER 100 EQUIP	(10) ILLUSTRATIONS		
					USABLE ON CODE	(a) 1-20	(b) 21-50	(c) 51-100	(a) 1-20	(b) 21-50			(c) 51-100	(a) FIG NO.	(b) ITEM NO. OR REFERENCE DESIGNATION
X1-H		IDLER, TAPE 543-2879-002 (13499)	EA	4											
P-H	3020-580-3850	IDLER-LARGE 543-2882-002 (13499)	EA	2		*	*	*	*	*		3-16	1A4AAMP5		
P-H	3020-530-3350	IDLER-LARGE 543-2882-002 (13499)	EA	REF		*	*	*	*	*		3-16	1A4AAMP6		
X1-H		BEARING, ROLLER GE47MILG3278 (60380)	EA	REF											
X1-H		IDLER, TAPE 543-2881-002 (13499)	EA	2											
P-H	5920-675-4625	SHAFT, TAPE 543-2964-003 (13499)	EA	1		*	*	*	*	*		3-16	1A4AAMP10		
X1-H		END, DRUM 543-2961-003 (13499)	EA	1											
X1-H		END, DRUM 543-2962-003 (13499)	EA	1											
X1-H		TUBE 543-2963-003 (13499)	EA	1											
X2-H		SUPPORT, END 543-2965-003 (13499)	EA	1											
X2-H		SUPPORT, END 543-3010-003 (13499)	EA	1											
X2-H		SUPPORT, CASTING 543-3010-014 (13499)	EA	1											
P-H		PIN, SHOULDER 543-2884-002 (13499)	EA	1		*	*	*	*	*					
X2-H		SUPPORT, END 543-2966-003 (13499)	EA	1											
X2-H		SUPPORT, END 543-3011-004 (13499)	EA	1											
X2-H		SUPPORT-CASTING 543-3011-014 (13499)	EA	1											
P-H		PIN, SHOULDER 543-2885-002 (13499)	EA	1		*	*	*	*	*					
P-H		NUT, TAPE ADJUSTABLE 543-2887-002 (13499)	EA	2		*	*	*	*	*					
X2-H	821-676-2818	TAPE, LONG 543-2892-002 (13499)	EA	2											
X1-H		EYELET, METALLIC 543-1621-002 (13499)	EA	REF											
X2-H		TAPE, LONG 543-2890-002 (13499)	EA	2											
X2-H	5821-676-2809	TAPE-SHORT 543-2893-002 (13499)	EA	2											
X1-H		RIVET, TUBULAR P3484X3-16NI (12014)	EA	10											
X1-H		EYELET, METALLIC SE33CADPL (90030)	EA	REF											
P-H		LUG, TAPE ADJUSTING 543-2886-002 (13499)	EA	2		*	*	*	*	*					
X2-H		CASTING-LUG 543-2886-012 (13499)	EA	2											
X2-H		TAPE-SHORT 543-2891-002 (13499)	EA	2											

SECTION III REPAIR PARTS FOR DIRECT SUPPORT, GENERAL SUPPORT, AND DEPOT MAINTENANCE (CONTINUED)

(1) SR CODE	(2) FEDERAL STOCK NUMBER	(3) DESCRIPTION  REFERENCE NUMBER & MFR. CODE	(4) UNIT OF MEAS  USABLE OR CODE	(5) QTY INC IN UNIT	(6) 30-DAY DS MAINT ALLOWANCE			(7) 30-DAY GS MAINT ALLOWANCE			(8) I VR NEW PER EQUIP CRNCY	(9) DEPOT MAINT ALW PER 100 EQUIP	(10) ILLUSTRATIONS	
					(a) 1-20	(b) 21-50	(c) 51-100	(a) 1-20	(b) 21-50	(c) 51-100			(a) FIG NO.	(b) ITEM NO. OR REFERENCE DESIGNATION
X2-H		BAR, CORE SUPPORT 544-2763-003 (13499)	EA	1										
X2-H		BAR, CASTING 544-2763-013 (13499)	EA	1										
X2-H		BAR, CORE SUPPORT 543-2968-003 (13499)	EA	1										
X2-H		SUPPORT, CORE 543-2895-002 (13499)	EA	16										
P-H		NUT, PLAIN 503-4935-001 (13499)	EA	30				*	*	*	*	*		
X2-H		SUPPORT-CORE 543-2894-002 (13499)	EA	16										
P-H		BEARING, BALL, ANNULAR S614FCHR37L02 (40920)	EA	2				*	*	*	*	*	3-16	1A44MP12
P-H		BEARING, BALL, ANNULAR S614FCHR37L02 (40920)	EA	REF				*	*	*	*	*	3-16	1A44MP13
P-H	5310-857-5548	NUT, SELF-LOCKING, HEXAGON MS21044D04 (96906)	EA	19				*	*	*	*	*		
X2-H		COVER, LONG 543-5153-002 (13499)	EA	1										
X2-H		COVER, SHORT 546-3363-002 (13499)	EA	1										
X1-H		RETAINER, CAPACITOR 543-2524-002 (13499)	EA	1										
X1-H		WASHER, DOUBLE 543-2925-002 (13499)	EA	30										
X1-H		SUPPORT, CORE 543-2927-002 (13499)	EA	14										
P-H		NUT-CORE ADJUSTABLE 503-4935-001 (13499)	EA	REF				*	*	*	*	*		
X1-H		SUPPORT, CORE 543-2926-002 (13499)	EA	14										
P-H	5340-619-7754	CLAMP, LOOP HP3M (09922)	EA	3				*	*	*	*	*		
X2-H		BRACKET, HO'D 543-2896-002 (13499)	EA	1										
P-H	5820-938-8292	TUNER SUBASSEMBLY 543-2954-003 (13499)	EA	1				*	*	*	*	*		
P-H	5999-790-0584	PRINTED CIRCUIT BOARD 543-2953-003 (13499)	EA	1				*	*	*	*	*	3-14	1A44T81
X1-H		PRINTED CIRCUIT BOARD 543-2952-003 (13499)	EA	1										
X1-H		EYELET, METALLIC 542-0810-003 (13499)	EA	REF										
P-H	5950-594-1217	COIL, RADIO FREQUENCY 18-124 (09250)	EA	1				*	*	*	*	*	3-14	1A44L32
P-H	5961-679-9435	SEMICONDUCTOR DEVICE, DIODE HD2L23 (73293)	EA	1				*	*	*	*	*	3-14	1A44C81
P-H	5905-104-8348	RESISTOR, FIXED, COMPOSITION RC20GF392K (81349)	EA	1				*	*	*	*	*	3-14	1A44R58
P-H	5910-901-8796	CAPACITOR, FIXED, MICA DIELECTRIC VCM15E241K (72136)	EA	1				*	*	*	*	*	3-14	1A44C171
X2-H		BRACKET, HOLD 543-2897-002 (13499)	EA	1										

SECTION III REPAIR PARTS FOR DIRECT SUPPORT, GENERAL SUPPORT, AND DEPOT MAINTENANCE (CONTINUED)

(1) SMR CODE	(2) FEDERAL STOCK NUMBER	(3) DESCRIPTION  REFERENCE NUMBER & MFR. CODE	(4) UNIT OF MEAS	(5) QTY REQD IN UNIT	(6) 30-DAY DS MAINT ALLOWANCE			(7) 30-DAY GS MAINT ALLOWANCE			(8) 1 YR ALW PER EQUIP CNTGCTY	(9) DEPOT MAINT ALW PER 100 EQUIP	(10) ILLUSTRATIONS	
					(a) 1-20	(b) 21-50	(c) 51-100	(a) 1-20	(b) 21-50	(c) 51-100			(a) FIG NO.	(b) ITEM NO. OR REFERENCE DESIGNATION
X2-H		BRACKET, HOLD 543-2898-002 (13499)	EA	1										
X2-H		BRACKET, HOLD 543-2899-002 (13499)	EA	1										
X2-H		SUPPORT, PLATE 543-2900-002 (13499)	EA	1										
X2-R		SUPPORT, PLATE 543-2901-002 (13499)	EA	1										
X2-H		SUPPORT, PLATE 543-2902-002 (13499)	EA	1										
P-F	5305-054-5650	SCREW, MACHINE MS51957-16 (96906)	EA	REF	*	*	*	*	*	*	*	*		
X1-H		COUPLING, SHAFT 548-1284-002 (13499)	EA	1									3-14	1A4A4MP11
X1-H		COUPLER, HALF 548-1282-002 (13499)	EA	1										1A4A4MP5
X1-H		COUPLER, HALF 548-1283-002 (13499)	EA	1										
P-H		SHAFT, STRAIGHT 543-2910-002 (13499)	EA	1				*	*	*	*	*		
X1-H		CLAMP, TAPE DRUM 543-2916-002 (13499)	EA	4										
X2-H		BAR, MOTOR SUPPORT 543-2917-002 (13499)	EA	1										
P-H		SCREW, SHIELD 543-2922-002 (13499)	EA	1				*	*	*	*	*		
A-H		SHIELD, RADIO FREQUENCY 543-5154-005 (13499)	EA	1										
X2-H		SHIELD, RADIO FREQUENCY 543-5155-005 (13499)	EA	1										
P-H	5310-297-9070	NUT, SELF-LOCKING, CLINCHED 68NG2-40 (72962)	EA	20				*	*	*	*	*		
X2-H		COVER, SHIELD 546-7886-004 (13499)	EA	1										
P-H	3110-773-9554	BEARING, BALL, ANNULAR SPR166PP (83086)	EA	1				*	*	*	*	*		
P-F	5820-822-9748	COIL, RADIO FREQUENCY 545-9074-003 (13499)	EA	1	*	*	*	*	*	*	*	*	3-16	1A4A4Z1
X2-F		FRAME, COIL 543-7882-003 (13499)	EA	REF										
X1-F		SHIELD, COIL 540-7617-002 (13499)	EA	REF										
X1-F		CAN, SHIELD 938X1188 (83722)	EA	REF										
X1-F		COIL, RADIO FREQUENCY 545-9073-002 (13499)	EA	8										1A4A411
M-H		WIRE, ELECTRICAL ANALAC36AWG (81554)	FT	32										
X1-H		FORM, COIL 506-0195-002 (13499)	EA	REF										
P-H		TERMINAL, LDC 506-1372-002 (13499)	EA	REF				*	*	*	*	*		
P-F		TERMINAL, FREETHRU G5687 (12615)	EA	REF	*	*	*	*	*	*	*	*		

SECTION III REPAIR PARTS FOR DIRECT SUPPORT, GENERAL SUPPORT, AND DEPOT MAINTENANCE (CONTINUED)

(1) SR CODE	(2) FEDERAL STOCK NUMBER	(3) DESCRIPTION  REFERENCE NUMBER & MFR. CODE	(4) UNIT OF MEAS	(5) QTY INC IN UNIT	(6) 30-DAY DS MAINT ALLOWANCE			(7) 30-DAY GS MAINT ALLOWANCE			(8) 1 YR ALW PER EQUIP CNTGCT	(9) DEPOT MAINT ALW PER 100 EQUIP	(10) ILLUSTRATIONS	
					(a)	(b)	(c)	(a)	(b)	(c)			(a)	(b)
					1-20	21-50	51-100	1-20	21-50	51-100			FIG NO.	ITEM NO. OR REFERENCE DESIGNATION
X1-F		CAPACITOR, VARIABLE 3188003 (72982)	EA	6										1A4A4C3
P-F	5910-766-8790	CAPACITOR, FIXED, MICA DIELECTRIC 22H5T13EG (14655)	EA	REF	*	*	*	*	*	*	*	*		1A4A4C2
P-F	5820-822-9738	COIL, RADIO FREQUENCY 545-9075-003 (13499)	EA	1	*	*	*	*	*	*	*	*	3-16	1A4A4Z2
X2-F		FRAME, COIL 543-7882-003 (13499)	EA	REF										
X1-F		SHIELD, COIL 543-1621-002 (13499)	EA	REF										
X1-F		CAN, SHIELD 938X1188 (83722)	EA	REF										
X1-F		COIL, RADIO FREQUENCY 545-9073-002 (13499)	EA	REF										1A4A4I2
M-H		WIRE, ELECTRICAL ANALAC36AWG (81554)	FT	REF										
X1-H		FORM, COIL 506-0195-002 (13499)	EA	REF										
P-H		TERMINAL, LUG 506-1372-002 (13499)	EA	REF				*	*	*	*	*		
P-F		TERMINAL, FEEDTHRU G5687 (12615)	EA	REF	*	*	*	*	*	*	*	*		
P-H	5910-542-7427	CAPACITOR, VARIABLE 3172000U2P034R (72982)	EA	1				*	*	*	*	*		1A4A4C7
X1-F		CAPACITOR, FIXED, MICA DIELECTRIC 22H5T13EG (14655)	EA	4										1A4A4C6
I-F	5935-615-8555	JACK, TIP SKT5BCWHT (98291)	EA	1	*	*	*	*	*	*	*	*	3-16	1A4A4J2
P-F	5820-822-9739	COIL, RADIO FREQUENCY 545-9076-003 (13499)	EA	1	*	*	*	*	*	*	*	*	3-16	1A4A4Z3
P-F		TERMINAL, FEEDTHRU G5687 (12615)	EA	REF	*	*	*	*	*	*	*	*		
X1-F		SHIELD, COIL 540-7617-002 (13499)	EA	REF										
X1-F		CAN, SHIELD 938X1188 (83722)	EA	REF										
X2-F		FRAME, COIL 543-7882-003 (13499)	EA	REF										
X1-F		COIL, RADIO FREQUENCY 545-9073-002 (13499)	EA	REF										1A4A4L3
M-H		WIRE, ELECTRICAL ANALAC36AWG (81554)	FT	REF										
X1-H		FORM, COIL 506-0195-002 (13499)	EA	REF										
P-H		TERMINAL, LUG 506-1372-002 (13499)	EA	REF				*	*	*	*	*		
P-F	5910-766-8790	CAPACITOR, FIXED, MICA DIELECTRIC 22H5T13EG (14655)	EA	REF	*	*	*	*	*	*	*	*		1A4A4C9
X1-F		CAPACITOR, VARIABLE 3188003 (72982)	EA	REF										1A4A4C10
P-F	5820-822-9740	COIL, RADIO FREQUENCY 545-9077-003 (13499)	EA	1	*	*	*	*	*	*	*	*	3-16	1A4A4Z4
X2-F		FRAME, COIL 543-7882-003 (13499)	EA	REF										

SECTION III REPAIR PARTS FOR DIRECT SUPPORT, GENERAL SUPPORT, AND DEPOT MAINTENANCE (CONTINUED)

(1) SIR CODE	(2) FEDERAL STOCK NUMBER	(3) DESCRIPTION  REFERENCE NUMBER & MFR. CODE	(4) UNIT OF MEAS  USABLE OR CODE	(5) QTY INC IN UNIT	(6) 30-DAY DS MAINT ALLOWANCE			(7) 30-DAY GS MAINT ALLOWANCE			(8) 1 YR ALW PER EQUIP CATEGY	(9) DEPOT MAINT ALW PER 100 EQUIP	(10) ILLUSTRATIONS	
					(a)	(b)	(c)	(a)	(b)	(c)			(a)	(b)
					1-20	21-50	51-100	1-20	21-50	51-100			FIG NO.	ITEM NO. OR REFERENCE DESIGNATION
XI-F		SHIELD, COIL 540-7617-002 (13499)	EA	REF										
XI-F		CAN, SHIELD 938K1188 (83722)	EA	REF										
XI-F		COIL, RADIO FREQUENCY 545-9073-002 (13499)	EA	REF										1A4A414
M-H		WIRE, ELECTRICAL ANALAC36AWG (13499)	FT	REF										
XI-H		FORM, COIL 506-0195-002 (13499)	EA	REF										
P-H		TERMINAL, LUG 506-1372-002 (13499)	EA	REF				*	*	*	*	*		
P-F		TERMINAL, FREDTRHU G5687 (12615)	EA	REF	*	*	*	*	*	*	*	*		
XI-F		CAPACITOR, VARIABLE J188003 (72982)	EA	REF										1A4A416
P-F	5910-766-8790	CAPACITOR, FIXED, MICA DIELECTRIC 2285T138C (14655)	EA	REF	*	*	*	*	*	*	*	*		1A4A414
P-F	5820-822-9741	COIL, RADIO FREQUENCY 545-9078-003 (13499)	EA	1	*	*	*	*	*	*	*	*	3-16	1A4A425
X2-F		FRAME, COIL 543-7882-003 (13499)	EA	REF										
X2-F		SHIELD, COIL 543-1621-002 (13499)	EA	REF										
XI-F		CAN, SHIELD 938K1188 (83722)	EA	REF										
XI-F		COIL, RADIO FREQUENCY 545-9073-002 (13499)	EA	REF										1A4A415
M-H		WIRE, ELECTRICAL ANALAC36AWG (81544)	FT	REF										
XI-H		FORM, COIL 506-0195-002 (13499)	EA	REF										
P-H		TERMINAL, LUG 506-1372-002 (13499)	EA	REF				*	*	*	*	*		
P-F		TERMINAL, FREDTRHU G5687 (12615)	EA	REF	*	*	*	*	*	*	*	*		
P-H	5910-542-7427	CAPACITOR, VARIABLE J17200002F034R (72982)	EA	1	*	*	*	*	*	*	*	*		1A4A419
XI-F		CAPACITOR, FIXED, MICA DIELECTRIC 2285T138C (14655)	EA	REF										1A4A418
P-F	5935-615-8555	JACK, TIP SMT928CHHT (98291)	EA	1	*	*	*	*	*	*	*	*	3-16	1A4A414
P-F	5820-822-9742	COIL, RADIO FREQUENCY 545-9079-003 (13499)	EA	1	*	*	*	*	*	*	*	*	3-16	1A4A426
X2-F		FRAME, COIL 543-7882-003 (13499)	EA	REF										
XI-F		SHIELD, COIL 540-7617-002 (13499)	EA	REF										
XI-F		CAN, SHIELD 938K1188 (83722)	EA	REF										
XI-F		COIL, RADIO FREQUENCY 545-9073-002 (13499)	EA	REF										1A4A416
M-H		WIRE, ELECTRICAL ANALAC36AWG (81544)	FT	REF										

SECTION III REPAIR PARTS FOR DIRECT SUPPORT, GENERAL SUPPORT, AND DEPOT MAINTENANCE (CONTINUED)

(1) S/R CODE	(2) FEDERAL STOCK NUMBER	(3) DESCRIPTION  REFERENCE NUMBER & MFR. CODE	(4) UNIT OF MEAS.	(5) QTY REQ'D PER UNIT	(6) 30-DAY DS MAINT ALLOWANCE			(7) 30-DAY GS MAINT ALLOWANCE			(8) 1 YR ALM PER EQUIP CMTY	(9) DEPOT MAINT ALM PER 100 EQUIP	(10) ILLUSTRATIONS (a) (b)	
					(a) 1-20	(b) 21-50	(c) 51-100	(a) 1-20	(b) 21-50	(c) 51-100			(a) FIG NO.	(b) ITEM NO. OR REFERENCE DESIGNATION
XI-H		FORM, COIL 506-0195-002 (13499)	EA	REF										
P-H		TERMINAL, LUG 506-1372-002 (13499)	EA	REF				*	*	*	*	*		
P-F		TERMINAL, FEEDTHRU G5687 (12615)	EA	REF	*	*	*	*	*	*	*	*		
XI-F		CAPACITOR, VARIABLE 3188003 (72982)	EA	REF										1A4A4C24
XI-F		CAPACITOR, FIXED, CERAMIC DIELECTRIC 338026C080350J (72982)	EA	1										1A4A4C22
XI-F		CAPACITOR, FIXED, CERAMIC DIELECTRIC 338023K280750J (72982)	EA	1										1A4A4C20
P-F	5821-679-9426	COIL, RADIO FREQUENCY 543-2984-003 (13499)	EA	1	*	*	*	*	*	*	*	*	3-16	1A4A4Z7
X2-F		FRAME, COIL 543-7882-003 (13499)	EA	REF										
XI-F		SHIELD, COIL 540-7617-002 (13499)	EA	REF										
XI-F		CAN, SHIELD 938K1188 (83722)	EA	REF										
XI-F		COIL, RADIO FREQUENCY 543-2945-002 (13499)	EA	5										1A4A4I7
M-H		WIRE, ELECTRICAL ANALAC32AWG (81544)	FT	REF										
XI-H		FORM, COIL 506-0195-002 (13499)	EA	REF										
P-H		TERMINAL, LUG 506-1372-002 (13499)	EA	REF				*	*	*	*	*		
P-F		TERMINAL, FEEDTHRU G5687 (12615)	EA	REF	*	*	*	*	*	*	*	*		
XI-F		CAPACITOR, VARIABLE 3188002 (72982)	EA	11										1A4A4C29
P-H	5910-819-1784	CAPACITOR, FIXED, MICA DIELECTRIC 22850568E (14655)	EA	REF				*	*	*	*	*		1A4A4C28
P-F	5820-679-9427	COIL, RADIO FREQUENCY 543-2985-003 (13499)	EA	1	*	*	*	*	*	*	*	*	3-16	1A4A4Z8
X2-F		FRAME, COIL 543-7882-003 (13499)	EA	REF										
XI-F		SHIELD, COIL 540-7617-002 (13499)	EA	REF										
XI-F		CAN, SHIELD 938K1188 (83722)	EA	REF										
XI-F		COIL, RADIO FREQUENCY 543-2945-002 (13499)	EA	REF										1A4A4I8
M-H		WIRE, ELECTRICAL ANALAC32AWG (81544)	FT	REF										
XI-H		FORM, COIL 506-0195-002 (13499)	EA	REF										
P-H		TERMINAL, LUG 506-1372-002 (13499)	EA	REF				*	*	*	*	*		
P-F		TERMINAL, FEEDTHRU G5687 (12615)	EA	REF	*	*	*	*	*	*	*	*		
XI-F		CAPACITOR, VARIABLE 3188002 (72982)	EA	REF										1A4A4C31



SECTION III REPAIR PARTS FOR DIRECT SUPPORT, GENERAL SUPPORT, AND DEPOT MAINTENANCE (CONTINUED)

(1) SR CODE	(2) FEDERAL STOCK NUMBER	(3) DESCRIPTION REFERENCE NUMBER & MFR. CODE	(4) UNIT OF MEAS	(5) QTY IN UNIT	(6) 30-DAY DS MAINT ALLOWANCE			(7) 30-DAY GS MAINT ALLOWANCE			(8) 1 YR ALW PER EQUIP CNTGCT	(9) DEPOT MAINT ALW PER 100 EQUIP	(10) ILLUSTRATIONS	
					(a) 1-20	(b) 21-50	(c) 51-100	(a) 1-20	(b) 21-50	(c) 51-100			(a) FIG NO.	(b) ITEM NO. OR REFERENCE DESIGNATION
XI-F		CAPACITOR, FIXED, CERAMIC DIELECTRIC 338026R2B056QJ (72982)	EA	1									1A2A4C30	
P-F	5821-679-9428	COIL, RADIO FREQUENCY 543-2986-003 (13499)	EA	1	*	*	*	*	*	*	*	3-16	1A2A4Z9	
X2-F		FRAME, COIL 543-7882-003 (13499)	EA	REF										
XI-F		SHIELD, COIL 540-7617-002 (13499)	EA	REF										
XI-F		CAN, SHIELD 938K1188 (83722)	EA	REF										
XI-F		COIL, RADIO FREQUENCY 543-2946-002 (13499)	EA	3									1A2A4I9	
M-H		WIRE, ELECTRICAL ANALAC28AWG (81554)	FT	REF										
XI-H		FORM, COIL 506-0195-002 (13499)	EA	REF										
P-H		TERMINAL, LUG 506-1372-002 (13499)	EA	REF				*	*	*	*			
P-F		TERMINAL, FERTHRU G5687 (12615)	EA	REF	*	*	*	*	*	*	*			
XI-F		CAPACITOR, VARIABLE 3188002 (72982)	EA	REF									1A2A4C34	
P-F	5910-850-0541	CAPACITOR, FIXED, MICA DIELECTRIC 2285943DG (14655)	EA	REF	*	*	*	*	*	*	*		1A2A4C33	
P-F	5821-679-9429	COIL, RADIO FREQUENCY 543-2987-003 (13499)	EA	1	*	*	*	*	*	*	*	3-16	1A2A4Z10	
X2-F		FRAME, COIL 543-7882-003 (13499)	EA	REF										
XI-F		SHIELD, COIL 540-7617-002 (13499)	EA	REF										
XI-F		CAN, SHIELD 938K1188 (83722)	EA	REF										
XI-F		COIL, RADIO FREQUENCY 543-2946-002 (13499)	EA	REF									1A2A4L10	
M-H		WIRE, ELECTRICAL ANALAC28AWG (81544)	FT	REF										
XI-H		FORM, COIL 506-0195-002 (13499)	EA	REF										
P-H		TERMINAL, LUG 506-1372-002 (13499)	EA	REF				*	*	*	*			
P-F		TERMINAL, FERTHRU G5687 (12615)	EA	REF	*	*	*	*	*	*	*			
XI-F		CAPACITOR, VARIABLE 3188002 (72982)	EA	REF									1A2A4C36	
XI-F		CAPACITOR, FIXED, CERAMIC DIELECTRIC 338026R2B0390G (72982)	EA	1									1A2A4C35	
P-F	5821-679-9430	COIL, RADIO FREQUENCY 543-2988-003 (13499)	EA	1	*	*	*	*	*	*	*	3-16	1A2A4Z11	
X2-F		FRAME, COIL 543-7882-003 (13499)	EA	REF										
XI-F		SHIELD, COIL 540-7617-002 (13499)	EA	REF										
XI-F		CAN, SHIELD 938K1188 (83722)	EA	REF										

SECTION III REPAIR PARTS FOR DIRECT SUPPORT, GENERAL SUPPORT, AND DEPOT MAINTENANCE (CONTINUED)

(1) SAR CODE	(2) FEDERAL STOCK NUMBER	(3) DESCRIPTION  REFERENCE NUMBER & MFR. CODE	(4) UNIT OF MEAS	(5) QTY REQ. IN UNIT	(6) 30-DAY DS MAINT ALLOWANCE			(7) 30-DAY GS MAINT ALLOWANCE			(8) 1 YR ALW PER EQUIP CWTGCT	(9) DEPOT MAINT ALW PER 100 EQUIP	(10) ILLUSTRATIONS	
					(a)	(b)	(c)	(a)	(b)	(c)			(a)	(b)
					1-20	21-50	51-100	1-20	21-50	51-100			FIG NO.	ITEM NO. OR REFERENCE DESIGNATION
XL-F		COIL, RADIO FREQUENCY 543-2947-002 (13499)	EA	4										1A4A4L11
M-H		WIRE, ELECTRICAL ANALAC26AWG (81554)	FT	REF										
XL-H		FORM, COIL 506-0195-002 (13499)	EA	REF										
P-H		TERMINAL, LUG 506-1372-002 (13499)	EA	REF				*	*	*	*	*		
P-F		TERMINAL, FEEDTHRU G5687 (12615)	EA	REF	*	*	*	*	*	*	*	*		
P-H	5910-667-6637	CAPACITOR, VARIABLE 3188001 (72982)	EA	1				*	*	*	*	*		1A4A4C39
P-F	5821-679-9431	COIL, RADIO FREQUENCY 543-2989-003 (13499)	EA	1	*	*	*	*	*	*	*	*	3-16	1A4A4Z12
X2-F		FRAME, COIL 543-7882-003 (13499)	EA	REF										
XL-F		SHIELD, COIL 540-7617-002 (13499)	EA	REF										
XL-F		CAN, SHIELD 938K1188 (83722)	EA	REF										
XL-F		COIL, RADIO FREQUENCY 543-2947-002 (13499)	EA	REF										1A4A4L12
M-H		WIRE, ELECTRICAL ANALAC26AWG (81544)	FT	REF										
XL-H		FORM, COIL 506-0195-002 (13499)	EA	REF										
P-H		TERMINAL, LUG 506-1372-002 (13499)	EA	REF				*	*	*	*	*		
P-F		TERMINAL, FEEDTHRU G5687 (12615)	EA	REF	*	*	*	*	*	*	*	*		
P-H	5910-667-6637	CAPACITOR, VARIABLE 3188001 (72982)	EA	1				*	*	*	*	*		1A4A4C41
XL-F		CAPACITOR, FIXED, MICA DIELECTRIC 22H5Q3DG (14655)	EA	1				*	*	*	*	*		1A4A4C40
P-F	5821-679-9432	COIL, RADIO FREQUENCY 543-2990-003 (13499)	EA	1	*	*	*	*	*	*	*	*	3-16	1A4A4Z13
X2-F		FRAME, COIL 543-7882-003 (13499)	EA	REF										
XL-F		SHIELD, COIL 540-7617-002 (13499)	EA	REF										
XL-F		CAN, SHIELD 938K1188 (83722)	EA	REF										
XL-F		COIL, RADIO FREQUENCY 543-2947-002 (13499)	EA	REF										1A4A4L13
M-H		WIRE, ELECTRICAL ANALAC26AWG (81544)	FT	REF										
XL-H		FORM, COIL 506-0195-002 (13499)	EA	REF										
P-H		TERMINAL, LUG 506-1372-002 (13499)	EA	REF				*	*	*	*	*		
P-F		TERMINAL, FEEDTHRU G5687 (12615)	EA	REF	*	*	*	*	*	*	*	*		
P-H	5910-667-6637	CAPACITOR, VARIABLE 3188001 (72982)	EA	1				*	*	*	*	*		1A4A4C43

T e x t

(1) SIR CODE	(2) FEDERAL STOCK NUMBER	(3) DESCRIPTION  REFERENCE NUMBER & MFR. CODE	(4) UNIT OF MEAS	(5) QTY INC IN UNIT	(6) 30-DAY DS MAINT ALLOWANCE			(7) 30-DAY GS MAINT ALLOWANCE			(8) 1 YR ALMPER EQUIP CWTQY	(9) DEPOT MAINT ALMPER 100 EQUIP	(a) FIG NO.	(10) ILLUSTRATIONS	
					(a) 1-20	(b) 21-50	(c) 51-100	(a) 1-20	(b) 21-50	(c) 51-100				(b)	(c)
XI-F		CAPACITOR, FIXED, CERAMIC DIELECTRIC OC22SEB50D (81349)	EA	1										1A444C42	
P-F	5820-822-9743	COIL, RADIO FREQUENCY 545-9080-003 (13499)	EA	1	*	*	*	*	*	*	*	*	3-16	1A444Z14	
X2-F		FRAME, COIL 543-7882-003 (13499)	EA	REF											
XI-F		SHIELD, COIL 540-7617-002 (13499)	EA	REF											
XI-F		CAN, SHIELD 938X1188 (83722)	EA	REF											
XI-F		COIL, RADIO FREQUENCY 545-9073-002 (13499)	EA	REF											
M-H		WIRE, ELECTRICAL ANALAC36AWG (81554)	FT	REF											
XI-H		FORM, COIL 906-0195-002 (13499)	EA	REF											
P-H		TERMINAL, LDG 906-1372-002 (13499)	EA	REF				*	*	*	*	*			
P-F		TERMINAL, FREQUENCY G5687 (12615)	EA	REF	*	*	*	*	*	*	*	*			
XI-F		CAPACITOR, VARIABLE 3188003 (72982)	EA	REF										1A444C51	
XI-F		CAPACITOR, FIXED, MICA DIELECTRIC MEOP6810500WV (72136)	EA	1										1A444C50	
XI-F		CAPACITOR, FIXED, MICA DIELECTRIC 25H5T15EG (14655)	EA	REF										1A444C49	
P-H		TERMINAL, FREQUENCY 5484 (12615)	EA	REF				*	*	*	*	*			
M-H		WIRE, ELECTRICAL ANALAC28AWG (81554)	FT	REF											
P-F	5820-822-9744	COIL, RADIO FREQUENCY 545-9081-003 (13499)	EA	1	*	*	*	*	*	*	*	*	3-16	1A444Z15	
X2-F		FRAME, COIL 543-7882-003 (13499)	EA	REF											
XI-F		SHIELD, COIL 540-7617-002 (13499)	EA	REF											
XI-F		CAN, SHIELD 938X1188 (83722)	EA	REF											
XI-F		COIL, RADIO FREQUENCY 543-2945-002 (13499)	EA	REF											
M-H		WIRE, ELECTRICAL ANALAC32AWG (81554)	FT	REF											
XI-H		FORM, COIL 906-0195-002 (13499)	EA	REF											
P-H		TERMINAL, LDG 906-1372-002 (13499)	EA	REF				*	*	*	*	*			
P-F		TERMINAL, FREQUENCY G5687 (12615)	EA	REF	*	*	*	*	*	*	*	*			
XI-F		CAPACITOR, VARIABLE 3188002 (72982)	EA	REF										1A444C54	
P-F	591-060-9619	CAPACITOR, FIXED, MICA DIELECTRIC 22H5T15EG (14655)	EA	1	*	*	*	*	*	*	*	*		1A444C53	
XI-F		CAPACITOR, FIXED, CERAMIC DIELECTRIC 33802352H0620J (72982)	EA	1										1A444C52	

SECTION III REPAIR PARTS FOR DIRECT SUPPORT, GENERAL SUPPORT, AND DEPOT MAINTENANCE (CONTINUED)

(1) SNR CODE	(2) FEDERAL STOCK NUMBER	(3) DESCRIPTION  REFERENCE NUMBER & MFR. CODE	(4) UNIT OF MEAS	(5) QTY INC IN UNIT	(6) 30-DAY DS MAINT ALLOWANCE			(7) 30-DAY GS MAINT ALLOWANCE			(8) 1 YR ALW PER EQUIP CNTGTY	(9) DEPOT MAINT ALW PER 100 EQUIP	(10) ILLUSTRATIONS		
					USABLE ON CODE	(a)	(b)	(c)	(a)	(b)			(c)	(a) FIG NO.	(b) ITEM NO. OR REFERENCE DESIGNATION
						1-20	21-50	51-100	1-20	21-50			51-100		
M-H		WIRE, ELECTRICAL ANALAC28AWG (81544)	FT	REF											
P-H		TERMINAL, FEEDTHRU 5484 (12615)	EA	REF				*	*	*	*	*			
P-F	5821-679-9435	COIL, RADIO FREQUENCY 543-2993-003 (13499)	EA	1	*	*	*	*	*	*	*	*	3-16	1A4A4Z16	
X2-F		FRAME, COIL 543-7882-003 (13499)	EA	REF											
X1-F		SHIELD, COIL 540-7617-002 (13499)	EA	REF											
X1-F		CAN, SHIELD 938X1188 (83722)	EA	REF											
X1-F		COIL, RADIO FREQUENCY 543-2946-002 (13499)	EA	REF											
M-H		WIRE, ELECTRICAL ANALAC28AWG (81544)	FT	REF											
X1-H		FORM, COIL 506-0195-002 (13499)	EA	REF											
P-H		TERMINAL, LUG 506-1372-002 (13499)	EA	REF				*	*	*	*	*			
P-F		TERMINAL, FEEDTHRU 05687 (12615)	EA	REF	*	*	*	*	*	*	*	*			
X1-F		CAPACITOR, VARIABLE 3188002 (72982)	EA	REF										1A4A4C57	
X1-F		CAPACITOR, FIXED, MICA DIELECTRIC 22H5722EG (14655)	EA	2										1A4A4C56	
X1-F		CAPACITOR, FIXED, CERAMIC DIELECTRIC 338023P2H0430J (72982)	EA	1										1A4A4C55	
M-H		WIRE, ELECTRICAL ANALAC28AWG (81554)	FT	REF											
P-H		TERMINAL, FEEDTHRU 5484 (12615)	EA	REF				*	*	*	*	*			
P-F	5821-679-9436	COIL, RADIO FREQUENCY 543-2994-003 (13499)	EA	1	*	*	*	*	*	*	*	*	3-16	1A4A4Z17	
X2-F		FRAME, COIL 543-7882-003 (13499)	EA	REF											
X1-F		SHIELD, COIL 540-7617-002 (13499)	EA	REF											
X1-F		CAN, SHIELD 938X1188 (83722)	EA	REF											
X1-F		COIL, RADIO FREQUENCY 546-1385-002 (13499)	EA	1											
M-H		WIRE, ELECTRICAL ANALAC28AWG (81554)	FT	REF											
X1-H		FORM, COIL 506-0195-002 (13499)	EA	REF											
P-H		TERMINAL, LUG 506-1372-002 (13499)	EA	REF				*	*	*	*	*			
P-F		TERMINAL, FEEDTHRU 05687 (12615)	EA	REF	*	*	*	*	*	*	*	*			
P-H	5910-667-663	CAPACITOR, VARIABLE 3188001 (72982)	EA	1				*	*	*	*	*		1A4A4C60	
P-F	5910-988-7897	CAPACITOR, FIXED, MICA DIELECTRIC 22H5Q33DG (14655)	EA	REF	*	*	*	*	*	*	*	*		1A4A4C59	

SECTION III REPAIR PARTS FOR DIRECT SUPPORT, GENERAL SUPPORT, AND DEPOT MAINTENANCE (CONTINUED)

(1) SIB CODE	(2) FEDERAL STOCK NUMBER	(3) DESCRIPTION  REFERENCE NUMBER & MFR. CODE	(4) UNIT OF MEAS	(5) QTY INC IN UNIT	(6) 30-DAY DS MAINT ALLOWANCE			(7) 30-DAY GS MAINT ALLOWANCE			(8) 1 YR ALM PER EQUIP CMTGTY	(9) DEPOT MAINT ALM PER 100 EQUIP	(10) ILLUSTRATIONS	
					(a) 1-20	(b) 21-50	(c) 51-100	(a) 1-20	(b) 21-50	(c) 51-100			(a) FIG NO.	(b) ITEM NO. OR REFERENCE DESIGNATION
XI-F		CAPACITOR, FIXED, CERAMIC DIELECTRIC CC22RH100D (81349)	EA	1									1A4A4C58	
M-H		WIRE, ELECTRICAL ANALAC28AWG (81554)	FT	REF										
P-H		TERMINAL FEEDTHRU 5484 (12615)	EA	REF				*	*	*	*	*		
P-F	5920-683-4436	COIL, RADIO FREQUENCY 544-2765-003 (13499)	EA	1	*	*	*	*	*	*	*	*	3-16	1A4A4Z18
X2-F		FRAME, COIL 543-7882-003 (13499)	EA	REF										
XI-F		SHIELD, COIL 540-7617-002 (13499)	EA	REF										
XI-F		CAN, SHIELD 938XCL188 (83722)	EA	REF										
XI-F		COIL, RADIO FREQUENCY 543-2945-002 (13499)	EA	REF									1A4A4L14	
M-H		WIRE, ELECTRICAL ANALAC32AWG (81554)	FT	REF										
XI-H		FORM, COIL 506-0195-002 (13499)	EA	REF										
P-H		TERMINAL, LUG 506-1372-002 (13499)	EA	REF				*	*	*	*	*		
P-F		TERMINAL, FEEDTHRU G5687 (12615)	EA	REF	*	*	*	*	*	*	*	*		
XI-F		CAPACITOR, VARIABLE 3188002 (72982)	EA	REF									1A4A4C65	
P-H	5910-832-5724	CAPACITOR, FIXED, MICA DIELECTRIC 22H5Q6889 (14555)	EA	1				*	*	*	*	*	1A4A4C64	
P-F	5820-683-4435	COIL, RADIO FREQUENCY 544-2766-003 (13499)	EA	1	*	*	*	*	*	*	*	*	3-16	1A4A4Z19
X2-F		FRAME, COIL 543-7882-003 (13499)	EA	REF										
XI-F		SHIELD, COIL 546-7617-002 (13449)	EA	REF										
XI-F		CAN, SHIELD 938XCL188 (83722)	EA	REF										
XI-F		COIL, RADIO FREQUENCY 543-2945-002 (13499)	EA	REF									1A4A4L15	
M-H		WIRE, ELECTRICAL ANALAC32AWG (81554)	FT	REF										
XI-H		FORM, COIL 506-0195-002 (13499)	EA	REF										
P-H		TERMINAL, LUG 506-1372-002 (13499)	EA	REF				*	*	*	*	*		
P-F		TERMINAL, FEEDTHRU G5687 (12615)	EA	REF	*	*	*	*	*	*	*	*		
XI-F		CAPACITOR, VARIABLE 3188002 (72982)	EA	REF									1A4A4C69	
XI-F		CAPACITOR, FIXED, MICA DIELECTRIC 22H5Q75EG (14655)	EA	2									1A4A4C68	
P-F	5820-683-4434	COIL, RADIO FREQUENCY 544-2767-003 (13499)	EA	1	*	*	*	*	*	*	*	*	3-16	1A4A4Z20
X2-F		FRAME, COIL 543-7882-003 (13499)	EA	REF										

SECTION III REPAIR PARTS FOR DIRECT SUPPORT, GENERAL SUPPORT, AND DEPOT MAINTENANCE (CONTINUED)

(1) SNR CODE	(2) FEDERAL STOCK NUMBER	(3) DESCRIPTION  REFERENCE NUMBER & MFR. CODE	(4) UNIT OF MEAS	(5) QTY REQD IN UNIT	(6) 30-DAY DS MAINT ALLOWANCE			(7) 30-DAY GS MAINT ALLOWANCE			(8) 1 YR ALM PER EQUIP CNTGNCY	(9) DEPOT MAINT ALM PER 100 EQUIP	(10) ILLUSTRATIONS  (a) FIG NO.	(11) ITEM NO. OR REFERENCE DESIGNATION
					(a)	(b)	(c)	(a)	(b)	(c)				
					1-20	21-50	51-100	1-20	21-50	51-100				
XL-F		SHIELD, COIL 540-7617-002 (13499)	EA	REF										
XL-F		CAN, SHIELD 938X1188 (83722)	EA	REF										
XL-F		COIL, RADIO FREQUENCY 543-2945-002 (13499)	EA	REF										
M-H		WIRE, ELECTRICAL ANALAC32AWG (81544)	FT	REF										
XL-H		FORM, COIL 506-0195-002 (13499)	EA	REF										
P-H		TERMINAL, LUG 506-1372-002 (13499)	EA	REF				*	*	*	*			
P-F		TERMINAL, FEEDTHRU G5687 (12615)	EA	REF	*	*	*	*	*	*	*			
XL-F		CAPACITOR, VARIABLE 3188002 (72982)	EA	REF									1A444C71	
P-F	5910-766-8790	CAPACITOR, FIXED, MICA DIELECTRIC 22H5T13EG (14655)	EA	REF	*	*	*	*	*	*	*		1A444C73	
P-H		TERMINAL, FEEDTHRU 5484 (12615)	EA	REF				*	*	*	*			
P-F	5820-822-9745	COIL, RADIO FREQUENCY 545-9082-003 (13499)	EA	1	*	*	*	*	*	*	*	3-16	1A444Z21	
X2-F		FRAME, COIL 543-7882-003 (13499)	EA	REF										
XL-F		SHIELD, COIL 540-7617-002 (13499)	EA	REF										
XL-F		CAN, SHIELD 938X1188 (83722)	EA	REF										
XL-F		COIL, RADIO FREQUENCY 545-9073-002 (13499)	EA	REF									1A444L17	
M-H		WIRE, ELECTRICAL ANALAC36AWG (81544)	FT	REF										
XL-H		FORM, COIL 506-0195-002 (13499)	EA	REF										
P-H		TERMINAL, LUG 506-1372-002 (13499)	EA	REF				*	*	*	*			
P-F		TERMINAL, FEEDTHRU G5687 (12615)	EA	REF	*	*	*	*	*	*	*			
XL-F		CAPACITOR, VARIABLE 3188003 (72982)	EA	REF									1A444C77	
XL-F		CAPACITOR, FIXED, MICA DIELECTRIC 22H5T15EG (14655)	EA	REF									1A444C78	
XL-F		CAPACITOR, FIXED, MICA DIELECTRIC 22H5T36EG (14655)	EA	2									1A444C79	
P-H		TERMINAL, FEEDTHRU 5484 (12615)	EA	REF				*	*	*	*			
P-F	5820-679-9440	COIL, RADIO FREQUENCY 543-2999-003 (13499)	EA	1	*	*	*	*	*	*	*	3-16	1A444Z22	
X2-F		FRAME, COIL 543-7882-003 (13499)	EA	REF										
XL-F		SHIELD, COIL 540-7617-002 (13499)	EA	REF										
XL-F		CAN, SHIELD 938X1188 (83722)	EA	REF										

SECTION III REPAIR PARTS FOR DIRECT SUPPORT, GENERAL SUPPORT, AND DEPOT MAINTENANCE (CONTINUED)

(1) SQR CODE	(2) FEDERAL STOCK NUMBER	(3) DESCRIPTION  REFERENCE NUMBER & MFR. CODE	(4) UNIT OF MEAS  USABLE ON CODE	(5) QTY INC IN UNIT	(6) 30-DAY DS MAINT ALLOWANCE			(7) 30-DAY GS MAINT ALLOWANCE			(8) 1 YR ALM PER EQUIP COST	(9) 100 EQUIP PER 100 EQUIP	(10) ILLUSTRATIONS	
					(a) 1-20	(b) 21-50	(c) 51-100	(a) 1-20	(b) 21-50	(c) 51-100			(a) FIG NO.	(b) ITEM NO. OR REFERENCE DESIGNATION
					XI-F		COIL, RADIO FREQUENCY 543-2945-002 (13499)	EA	REF					
M-H		WIRE, ELECTRICAL ANALAC28AWG (81554)	FT	REF										
XI-H		FORM, COIL 506-0195-002 (13499)	EA	REF										
P-H		TERMINAL, LUG 506-1372-002 (13499)	EA	REF				*	*	*	*	*		
P-F		TERMINAL, FEEDTHRU G5687 (12615)	EA	REF	*	*	*	*	*	*	*	*		
XI-F		CAPACITOR, VARIABLE 3188002 (72982)	EA	REF									1A4A4C80	
XI-F		CAPACITOR, FIXED, MICA DIELECTRIC 22H5Q75EG (14655)	EA	REF									1A4A4C81	
XI-F		CAPACITOR, FIXED, MICA DIELECTRIC 22H5T36EG (14655)	EA	REF									1A4A4C83	
P-F	5910-762-2945	CAPACITOR, FIXED, MICA DIELECTRIC 22H5T47EG (14655)	EA	1	*	*	*	*	*	*	*	*	1A4A4C82	
P-H		TERMINAL, FEEDTHRU 5484 (12615)	EA	REF				*	*	*	*	*		
P-F	5821-679-9441	COIL, RADIO FREQUENCY 543-3000-003 (13499)	EA	1	*	*	*	*	*	*	*	*	3-16 1A4A4Z23	
XI-F		FRAME, COIL 543-7882-003 (13499)	EA	REF										
XI-F		SHIELD, COIL 540-7617-002 (13499)	EA	REF										
XI-F		CAN, SHIELD 938X1188 (83722)	EA	REF										
XI-F		COIL, RADIO FREQUENCY 543-2946-002 (13499)	EA	REF									1A4A4L19	
M-H		WIRE, ELECTRICAL ANALAC28AWG (81554)	FT	REF										
XI-H		FORM, COIL 543-2874-002 (13499)	EA	REF										
P-H		TERMINAL, LUG 506-0195-992 (13499)	EA	REF				*	*	*	*	*		
P-F		TERMINAL, FEEDTHRU G5687 (12615)	EA	REF	*	*	*	*	*	*	*	*		
XI-F		CAPACITOR, VARIABLE 3188002 (72982)	EA	REF									1A4A4C84	
P-H	5910-725-9294	CAPACITOR, FIXED, MICA DIELECTRIC 22H5Q51EG (14655)	EA	1				*	*	*	*	*	1A4A4C85	
P-H	5910-728-1577	CAPACITOR, FIXED, MICA DIELECTRIC 22H5T43EG (14655)	EA	1				*	*	*	*	*	1A4A4C86	
P-H		TERMINAL, FEEDTHRU 5484 (12615)	EA	REF				*	*	*	*	*		
P-F	5821-679-9442	COIL, RADIO FREQUENCY 543-3001-003 (13499)	EA	1	*	*	*	*	*	*	*	*	3-16 1A4A4Z24	
XI-F		FRAME, COIL 543-7882-003 (13499)	EA	REF										
XI-F		SHIELD, COIL 540-7617-002 (13499)	EA	REF										
XI-F		CAN, SHIELD 938X1188 (83722)	EA	REF										

SECTION III REPAIR PARTS FOR DIRECT SUPPORT, GENERAL SUPPORT, AND DEPOT MAINTENANCE (CONTINUED)

(1) SWR CODE	(2) FEDERAL STOCK NUMBER	(3) DESCRIPTION  REFERENCE NUMBER & MFR. CODE	(4) UNIT OF MEAS	(5) QTY INC IN UNIT	(6) 30-DAY DS MAINT ALLOWANCE			(7) 30-DAY GS MAINT ALLOWANCE			(8) 1 YR ALW PER EQUIP CNTGTY	(9) DEPOT MAINT ALW PER 100 EQUIP	(10) ILLUSTRATIONS	
					(a) 1-20	(b) 21-50	(c) 51-100	(a) 1-20	(b) 21-50	(c) 51-100			(a) FIG NO.	(b) ITEM NO. OR REFERENCE DESIGNATION
					XI-F		COIL, RADIO FREQUENCY 543-2947-002 (13499)	EA	REF					
M-H		WIRE, ELECTRICAL ANALAC24AWG (81554)	FT	REF										
XI-H		FORM, COIL 506-0195-002 (13499)	EA	REF										
P-H		TERMINAL, LUG 506-1372-002 (13499)	EA	REF				*	*	*	*	*		
P-F		TERMINAL, FEEDTHRU G5687 (12615)	EA	REF	*	*	*	*	*	*	*	*		
P-H	5910-667-6637	CAPACITOR, VARIABLE 3188001 (72982)	EA	1				*	*	*	*	*	1A4A4C87	
P-F	5910-993-2380	CAPACITOR, FIXED, MICA DIELECTRIC 22H5Q12CJ (14655)	EA	REF	*	*	*	*	*	*	*	*	1A4A4C88	
XI-F		CAPACITOR, FIXED, MICA DIELECTRIC 22H5722EG (14655)	EA	REF									1A4A4C89	
P-H		TERMINAL, FEEDTHRU 5484 (12615)	EA	REF				*	*	*	*	*		
P-F	5820-822-9746	COIL, RADIO FREQUENCY 545-9083-003 (13499)	EA	1	*	*	*	*	*	*	*	*	3-16 1A4A4Z25	
X2-F		FRAME, COIL 543-7882-003 (13499)	EA	REF										
XI-F		SHIELD, COIL 540-7617-002 (13499)	EA	REF										
XI-F		CAN, SHIELD 938K1188 (83722)	EA	REF										
XI-F		COIL, RADIO FREQUENCY 545-9072-002 (13499)	EA	1										
M-H		WIRE, ELECTRICAL ANALAC24AWG (81554)	FT	4										
XI-H		FORM, COIL 506-0195-002 (13499)	EA	REF										
P-H		TERMINAL, LUG 506-1372-002 (13499)	EA	REF				*	*	*	*	*		
P-F		TERMINAL, FEEDTHRU G5687 (12615)	EA	REF	*	*	*	*	*	*	*	*		
XI-F		CAPACITOR, VARIABLE 3188003 (72982)	EA	REF									1A4A4C120	
P-F	5910-984-5253	CAPACITOR, FIXED, MICA DIELECTRIC 22H5T33EG (14655)	EA	REF	*	*	*	*	*	*	*	*	1A4A4C118	
P-F	5910-984-5253	CAPACITOR, FIXED, MICA DIELECTRIC 22H5T33EG (14655)	EA	REF	*	*	*	*	*	*	*	*	1A4A4C119	
M-H		WIRE, ELECTRICAL ANALAC28AWG (81554)	FT	REF										
P-H		TERMINAL, FEEDTHRU 5484 (12615)	EA	REF				*	*	*	*	*		
P-F	5820-0822-9747	COIL, RADIO FREQUENCY 545-9084-003 (13499)	EA	1	*	*	*	*	*	*	*	*	3-16 1A4A4Z26	
X2-F		FRAME, COIL 543-7882-003 (13499)	EA	REF										
XI-F		SHIELD, COIL 540-7617-002 (13499)	EA	REF										
XI-F		CAN, SHIELD 938K1188 (83722)	EA	REF										



SECTION III REPAIR PARTS FOR DIRECT SUPPORT, GENERAL SUPPORT, AND DEPOT MAINTENANCE (CONTINUED)

(1) SIR CODE	(2) FEDERAL STOCK NUMBER	(3) DESCRIPTION  REFERENCE NUMBER & MFR. CODE	(4) UNIT OF MEAS	(5) QTY INC IN UNIT	(6) 30-DAY DS MAINT ALLOWANCE			(7) 30-DAY GS MAINT ALLOWANCE			(8) 1 YR ALW PER EQUIP CNTGCTY	(9) DEPOT MAINT ALW PER 100 EQUIP	(10) ILLUSTRATIONS	
					(a) 1-20	(b) 21-50	(c) 51-100	(a) 1-20	(b) 21-50	(c) 51-100			(a) FIG NO.	(b) ITEM NO. OR REFERENCE DESIGNATION
XI-F		COIL, RADIO FREQUENCY 543-2949-002 (13499)	EA	4										1A4A4126
M-H		WIRE, ELECTRICAL ANALAC26AWG (81554)	FT	REF										
XI-H		FORM, COIL 506-0195-002 (13499)	EA	REF										
P-H		TERMINAL, LUG 506-1372-002 (13499)	EA	REF				*	*	*	*	*		
P-F		TERMINAL, FEEDTHRU G5687 (12615)	EA	REF	*	*	*	*	*	*	*	*		
P-H	5910-667-6637	CAPACITOR, VARIABLE 3188001 (72982)	EA	1				*	*	*	*	*		1A4A4C125
XI-F		CAPACITOR, FIXED, MICA DIELECTRIC 22H5Q270G (14655)	EA	1										
XI-F		CAPACITOR, FIXED, MICA DIELECTRIC DM00020J (72136)	EA	1										
P-H		TERMINAL, FEEDTHRU 5484 (12615)	EA	REF				*	*	*	*	*		
M-H		WIRE, ELECTRICAL 00702-1322 (70567)	FT	REF										
P-F	5823-679-9445	COIL, RADIO FREQUENCY 543-3004-003 (13499)	EA	1	*	*	*	*	*	*	*	*	3-16	1A4A4Z27
X2-F		FRAME, COIL 543-2971-003 (13499)	EA	2										
XI-F		SHIELD, COIL 543-1621-002 (13499)	EA	REF										
XI-F		CAN, SHIELD 938K1188 (83722)	EA	REF										
XI-F		COIL, RADIO FREQUENCY 543-2949-002 (13499)	EA	REF										1A4A4127
M-H		WIRE, ELECTRICAL ANALAC26AWG3 (81554)	FT	REF										
XI-H		FORM, COIL 506-0195-002 (13499)	EA	REF										
P-H		TERMINAL, LUG 506-1372-002 (13499)	EA	REF				*	*	*	*	*		
P-F		TERMINAL, FEEDTHRU G5687 (12615)	EA	REF	*	*	*	*	*	*	*	*		
XI-F		CAPACITOR, VARIABLE 317100COP017R (72982)	EA	1										1A4A4C129
XI-F		CAPACITOR, FIXED, CERAMIC DIELECTRIC CC22SH200J (81349)	EA	1										1A4A4C130
P-H	5910-681-7140	CAPACITOR, FIXED, MICA DIELECTRIC 22H5T18EG (14655)	EA	1				*	*	*	*	*		1A4A4G131
XI-F		CAPACITOR, VARIABLE 3173000U2P034R (72982)	EA	2										1A4A4C91
P-F	5821-679-9446	COIL, RADIO FREQUENCY 543-3005-003 (13499)	EA	1	*	*	*	*	*	*	*	*	3-16	1A4A4Z28
X2-F		FRAME, COIL 543-2971-003 (13499)	EA	REF										
XI-F		SHIELD, COIL 543-1621-002 (13499)	EA	REF										
XI-F		CAN, SHIELD 938K1188 (83722)	EA	REF										

SECTION III REPAIR PARTS FOR DIRECT SUPPORT, GENERAL SUPPORT, AND DEPOT MAINTENANCE (CONTINUED)

(1) SIR CODE	(2) FEDERAL STOCK NUMBER	(3) DESCRIPTION  REFERENCE NUMBER & MFR. CODE	(4) UNIT OF MEAS	(5) QTY INC IN UNIT	(6) 30-DAY DS MAINT ALLOWANCE			(7) 30-DAY GS MAINT ALLOWANCE			(8) 1 YR ALW PER EQUIP CATGCT	(9) DEPOT MAINT ALW PER 100 EQUIP	(10) ILLUSTRATIONS	
					(a) 1-20	(b) 21-50	(c) 51-100	(a) 1-20	(b) 21-50	(c) 51-100			(a) FIG NO.	(b) ITEM NO. OR REFERENCE DESIGNATION
XL-F		COIL, RADIO FREQUENCY 543-2948-002 (13499)	EA	1									1A4A4128	
M-H		WIRE, ELECTRICAL ANALAC20AWG (81554)	FT	REF										
XL-F		FORM, COIL 506-0195-002 (13499)	EA	REF										
P-H		TERMINAL, LUG 506-1372-002 (13499)	EA	REF				*	*	*	*	*		
P-F		TERMINAL, FEEDTHRU G5687 (12615)	EA	REF	*	*	*	*	*	*	*	*		
XL-F		CAPACITOR, VARIABLE 31710000P039R (72982)	EA	1									1A4A4C138	
XL-F		CAPACITOR, FIXED, CERAMIC DIELECTRIC 318026R2H9980G (72982)	EA	1									1A4A4C137	
XL-F		CAPACITOR, VARIABLE 31730000ZP034R (72982)	EA	REF									1A4A4C176	
P-H		TERMINAL, FEEDTHRU 5484 (12615)	EA	REF				*	*	*	*	*		
M-H		WIRE, ELECTRICAL 00702-1322 (70567)	FT	REF										
M-H		WIRE, ELECTRICAL ANALAC28AWG (81554)	FT	REF										
P-F	5821679-9447	COIL, RADIO FREQUENCY 543-3006-003 (13499)	EA	1	*	*	*	*	*	*	*	*	3-16 1A4A4Z29	
X2-F		FRAME, COIL 543-7882-003 (13499)	EA	REF										
XL-F		SHIELD, COIL 540-7617-002 (13499)	EA	REF										
XL-F		CAN, SHIELD 938X1188 (83722)	EA	REF										
XL-F		COIL, RADIO FREQUENCY 543-2949-002 (13499)	EA	REF									1A4A4L29	
M-H		WIRE, ELECTRICAL ANALAC26AWG (81554)	FT	REF										
XL-H		FORM, COIL 506-0195-002 (13499)	EA	REF										
P-H		TERMINAL, LUG 506-1372-002 (13499)	EA	REF				*	*	*	*	*		
P-F		TERMINAL, FEEDTHRU G5687 (12615)	EA	REF	*	*	*	*	*	*	*	*		
P-H	5910-667-6637	CAPACITOR, VARIABLE 3188001 (72982)	EA	1				*	*	*	*	*	1A4A4C141	
XL-F		CAPACITOR, FIXED, CERAMIC DIELECTRIC CC22H24... (81349)	EA	1									1A4A4C140	
P-F	5820-822-9749	COIL, RADIO FREQUENCY 545-9085-003 (13499)	EA	1	*	*	*	*	*	*	*	*	3-16 1A4A4Z30	
X2-F		FRAME, COIL 543-7882-003 (13499)	EA	REF										
XL-F		SHIELD, COIL 540-7617-002 (13499)	EA	REF										
XL-F		CAN, SHIELD 938X1188 (83722)	EA	REF										
XL-F		COIL, RADIO FREQUENCY 543-2949-002 (13499)	EA	REF										

SECTION III REPAIR PARTS FOR DIRECT SUPPORT, GENERAL SUPPORT, AND DEPOT MAINTENANCE (CONTINUED)

(1) SBR CODE	(2) FEDERAL STOCK NUMBER	(3) DESCRIPTION  REFERENCE NUMBER & MFR. CODE	(4) UNIT OF MEAS	(5) QTY INC IN UNIT	(6) 30-DAY DS MAINT ALLOWANCE			(7) 30-DAY GS MAINT ALLOWANCE			(8) 1 YR ALW PER EQUIP CMTCTY	(9) DEPOT MAINT ALW PER 100 EQUIP	(10) ILLUSTRATIONS	
					(a) 1-20	(b) 21-50	(c) 51-100	(a) 1-20	(b) 21-50	(c) 51-100			(a) FIG NO.	(b) ITEM NO. OR REFERENCE DESIGNATION
M-H		WIRE, ELECTRICAL ANALAC26AWG (81544)	FT	REF										
XI-H		FORM, COIL 506-0195-002 (13499)	EA	REF										
P-H		TERMINAL, LUG 506-1372-002 (13495)	EA	REF				*	*	*	*			
P-F		TERMINAL, FEEDTHRU G5687 (12615)	EA	REF	*	*	*	*	*	*	*			
P-H	5910-667-6637	CAPACITOR, VARIABLE 3188001 (72982)	EA	1				*	*	*	*		1A4A4C149	
P-F	5910-936-7370	CAPACITOR, FIXED, MICA DIELECTRIC 22H5Q36OG (14655)	EA	REF	*	*	*	*	*	*	*		1A4A4C148	
P-H		TERMINAL, FEEDTHRU 5484 (12615)	EA	REF				*	*	*	*			
M-H		WIRE, ELECTRICAL ANALAC28AWG (81554)	FT	REF										
P-F	5945-542-7041	RELAY, ARMATURE 95-2943 (04221)	EA	1	*	*	*	*	*	*	*	3-16	1A4A4K2	
P-O	5960-262-0210	ELECTRON TUBE 5814A (89185)	EA	2	*	*	*	*	*	*	*	3-16	1A4A4V1	
P-C	5960-262-0210	ELECTRON TUBE 5814A (89185)	EA	REF	*	*	*	*	*	*	*	3-16	1A4A4V3	
P-C	5960-134-6004	ELECTRON TUBE 5749 (89185)	EA	6	*	*	*	*	*	*	*	3-16	1A4A4V2	
P-O	5960-134-6004	ELECTRON TUBE 5749 (89185)	EA	REF	*	*	*	*	*	*	*	3-16	1A4A4V4	
P-O	5960-134-6004	ELECTRON TUBE 5749 (89185)	EA	REF	*	*	*	*	*	*	*	3-16	1A4A4V5	
P-C	5960-134-6004	ELECTRON TUBE 5749 (89185)	EA	REF	*	*	*	*	*	*	*	3-16	1A4A4V7	
P-C	5960-134-6004	ELECTRON TUBE 5749 (89185)	EA	REF	*	*	*	*	*	*	*	3-16	1A4A4V8	
P-O	5960-134-6004	ELECTRON TUBE 5749 (89185)	EA	REF	*	*	*	*	*	*	*	3-16	1A4A4V10	
P-O	5960-615-0243	ELECTRON TUBE 6CL6 (49671)	EA	1	*	*	*	*	*	*	*	3-16	1A4A4V6	
P-C	5960-045-8639	ELECTRON TUBE 5654 (89185)	EA	1	*	*	*	*	*	*	*	3-16	1A4A4V9	
M-H		RUBBER CHANNEL 3021B2-1 (75183)	FT	1										
P-F	5960-860-7710	SHIELD ASSEMBLY 541-6554-003 (13499)	EA	2	*	*	*	*	*	*	*	3-16	1A4A4E1	
P-F	5960-860-7710	SHIELD ASSEMBLY 541-6554-003 (13499)	EA	REF	*	*	*	*	*	*	*	3-16	1A4A4E3	
P-H	5960-519-6952	SHIELD, ELECTRON 191-0P1001 (91662)	EA	2				*	*	*	*			
		-OR-												
P-H	5960-552-0236	SHIELD, ASSEMBLY 541-8166-002 (13499)	EA	2				*	*	*	*			
P-H	5960-686-8087	SHIELD, TUBE 541-8161-002 (13499)	EA	5				*	*	*	*			
XI-H		SHIELD 541-8161-012 (13499)	EA	5										
P-F	5340-769-2243	SPRING, HELICAL 541-8164-002 (13499)	EA	REF	*	*	*	*	*	*	*			

SECTION III REPAIR PARTS FOR DIRECT SUPPORT, GENERAL SUPPORT, AND DEPOT MAINTENANCE (CONTINUED)

(1) SR CODE	(2) FEDERAL STOCK NUMBER	(3) DESCRIPTION  REFERENCE NUMBER & MFR. CODE	(4) UNIT OF MEAS	(5) QTY INC IN UNIT	(6) 30-DAY DS MAINT ALLOWANCE			(7) 30-DAY GS MAINT ALLOWANCE			(8) YR ALW PER EQUIP CWTGCT	(9) DEPOT MAINT ALW PER 100 EQUIP	(10) ILLUSTRATIONS	
					(a) 1-20	(b) 21-50	(c) 51-100	(a) 1-20	(b) 21-50	(c) 51-100			(a) FIG NO.	(b) ITEM NO. OR REFERENCE DESIGNATION
P-H	5960-649-8665	RETAINER, ELECTRON TUBE 541-6521-002 (13499)	EA	5				*	*	*	*	*		
P-F	5960-564-4772	SHIELD ASSEMBLY 541-6551-003 (13499)	EA	6	*	*	*	*	*	*	*	*	3-16	1A4A4E2
P-F	5960-564-4772	SHIELD ASSEMBLY 541-6551-003 (13499)	EA	REF	*	*	*	*	*	*	*	*	3-16	1A4A4E4
P-F	5960-564-4772	SHIELD ASSEMBLY 541-6551-003 (13499)	EA	REF	*	*	*	*	*	*	*	*	3-16	1A4A4E5
P-F	5960-564-4772	SHIELD ASSEMBLY 541-6551-003 (13499)	EA	REF	*	*	*	*	*	*	*	*	3-16	1A4A4E7
P-F	5960-564-4772	SHIELD ASSEMBLY 541-6551-003 (13499)	EA	REF	*	*	*	*	*	*	*	*	3-16	1A4A4E8
P-F	5960-564-4772	SHIELD ASSEMBLY 541-6551-003 (13499)	EA	REF	*	*	*	*	*	*	*	*	3-16	1A4A4E10
P-F	5960-581-8696	SHIELD, ELECTRON 120-0P1001 (91662)	EA	REF	*	*	*	*	*	*	*	*		
		-OR-												
P-F	5960-614-8676	SHIELD, ELECTRON 541-8169-002 (13499)	EA	REF	*	*	*	*	*	*	*	*		
XI-H		SHIELD, TUBE 541-8158-002 (13499)	EA	REF										
XI-H		SHIELD 541-8158-012 (13499)	EA	REF										
P-F	5340-769-2240	SPRING, HELICAL 541-8163-002 (13499)	EA	REF	*	*	*	*	*	*	*	*		
XI-H		RETAINER, ELECTRON TUBE 541-6518-002 (13499)	EA	REF										
P-F	5960-686-7500	SHIELD ASSEMBLY 541-6555-003 (13499)	EA	1	*	*	*	*	*	*	*	*	3-16	1A4A4E6
P-H	5960-581-2293	SHIELD, ELECTRON 199-0P1001 (91662)	EA	3				*	*	*	*	*		
		-OR-												
P-H	5960-865-5067	SHIELD ASSEMBLY 541-8165-002 (13499)	EA	4				*	*	*	*	*		
P-H	5960-865-4501	SHIELD, TUBE 541-8162-002 (13499)	EA	4				*	*	*	*	*		
XI-H		SHIELD 541-8162-012 (13499)	EA	4										
P-F	5340-769-2243	SPRING, HELICAL 541-8164-002 (13499)	EA	REF	*	*	*	*	*	*	*	*		
P-H	5960-617-5785	RETAINER, ELECTRON TUBE 541-6522-002 (13499)	EA	3				*	*	*	*	*		
P-F	5960-858-5172	SHIELD ASSEMBLY 541-6550-003 (13499)	EA	1	*	*	*	*	*	*	*	*	3-16	1A4A4E9,
XI-H		SHIELD, ELECTRON 121-0P1001 (91662)	EA	REF										
		-OR-												
XI-H		SHIELD ASSEMBLY 541-8170-002 (13499)	EA	REF										
XI-H		SHIELD TUBE 541-8157-002 (13499)	EA	REF										
XI-H		SHIELD 541-8157-012 (13499)	EA	REF										
P-F	5340-769-2240	SPRING, HELICAL 541-8163-002 (13499)	EA	REF	*	*	*	*	*	*	*	*		
		RETAINER, ELECTRON TUBE 541-6517-002 (13499)	EA	REF										

TM 11-5820-555-24P  
SECTION III REPAIR PARTS FOR DIRECT SUPPORT, GENERAL SUPPORT, AND DEPOT MAINTENANCE (CONTINUED)

(1) SIR CODE	(2) FEDERAL STOCK NUMBER	(3) DESCRIPTION  REFERENCE NUMBER & MFR. CODE	(4) UNIT OF MEAS	(5) QTY INC IN UNIT	(6) 30-DAY DS MAINT ALLOWANCE			(7) 30-DAY GS MAINT ALLOWANCE			(8) 1 YR ALW PER EQUIP CNTGCTY	(9) DEPOT MAINT ALW PER 100 EQUIP	(10) ILLUSTRATIONS	
					(a)	(b)	(c)	(a)	(b)	(c)			(a)	(b)
					1-20	21-50	51-100	1-20	21-50	51-100			FIG NO.	ITEM NO. OR REFERENCE DESIGNATION
P-F	5305-054-5646	SCREW, MACHINE MS51957-12 (96906)	EA	REF	*	*	*	*	*	*	*			
P-F	5305-638-4247	SCREW, ASSEMBLED WASHER P346-6000-000 (77250)	EA	30	*	*	*	*	*	*	*			
P-H	5950-583-0904	CORE, ADJUSTABLE TUNER 57-802 (78488)	EA	1				*	*	*	*	3-13	1A4A4E24	
P-F	5305-054-5647	SCREW, MACHINE MS51957-13 (96906)	EA	REF	*	*	*	*	*	*	*			
P-F	5305-054-5648	SCREW, MACHINE MS51957-14 (96906)	EA	REF	*	*	*	*	*	*	*			
P-F		SCREW, CAPTIVE, SOCKETHEAD E2A540-8C3 (08664)	EA	REF	*	*	*	*	*	*	*			
P-F		SCREW, CAPTIVE 324-1682-100 (13499)	EA	REF	*	*	*	*	*	*	*			
P-F	5310-042-9609	WASHER, LOCK MS35388-78 (96906)	EA	REF	*	*	*	*	*	*	*			
P-F	5340-721-7680	RING, RETAINING MS16633-1025 (96906)	EA	6	*	*	*	*	*	*	*			
P-H	5305-054-5636	SCREW, MACHINE MS51957-2 (96906)	EA	REF	*	*	*	*	*	*	*			
P-F	5310-058-3829	WASHER, LOCK MS35336-77 (96906)	EA	REF	*	*	*	*	*	*	*			
P-F	5310-595-5421	WASHER, FLAT 310-6320-000 (79807)	EA	REF	*	*	*	*	*	*	*			
P-F		SPRING, HELICAL 543-2888-002 (13499)	EA	2	*	*	*	*	*	*	*		1A4AMP7	
P-F		SPRING, HELICAL 543-2888-002 (13499)	EA	REF	*	*	*	*	*	*	*		1A4AMP8	
P-F	5305-054-5649	SCREW, MACHINE MS51957-15 (96906)	EA	REF	*	*	*	*	*	*	*			
P-F	5305-770-2533	SCREW, MACHINE MS51959-13 (96906)	EA	REF	*	*	*	*	*	*	*			
P-F	5305-685-2375	SCREW, SHIELD 542-7680-002 (13499)	EA	3	*	*	*	*	*	*	*			
P-F	5305-763-7822	SCREW, MACHINE MS51959-14 (96906)	EA	REF	*	*	*	*	*	*	*			
P-F	5305-768-0336	SCREW, MACHINE MS51959-17 (96906)	EA	2	*	*	*	*	*	*	*			
P-F		NUT, PLAIN, HEXAGON P313-0156-000 (77250)	EA	29	*	*	*	*	*	*	*			
P-F		NUT, PLAIN, HEXAGON P313-0140-000 (77250)	EA	REF	*	*	*	*	*	*	*			
P-F	5310-011-1041	WASHER, LOCK MS35388-79 (96906)	EA	REF	*	*	*	*	*	*	*			
P-F	5305-673-6963	SCREW, MACHINE MS51959-28 (96906)	EA	REF	*	*	*	*	*	*	*			
P-F	5305-054-6650	SCREW, MACHINE MS51957-26 (96906)	EA	REF	*	*	*	*	*	*	*			
P-H		WASHER, FLAT 310-0054-000 (79807)	EA	REF				*	*	*	*			
P-H		TERMINAL, LUG SPL4040-4BOTTINNED (77147)	EA	REF				*	*	*	*			
P-F	5340-200-7377	RING, RETAINING MS16633-1015 (96906)	EA	9	*	*	*	*	*	*	*			

SECTION III REPAIR PARTS FOR DIRECT SUPPORT, GENERAL SUPPORT, AND DEPOT MAINTENANCE (CONTINUED)

(1) S/R CODE	(2) FEDERAL STOCK NUMBER	(3) DESCRIPTION  REFERENCE NUMBER & MFR. CODE	(4) UNIT OF MEAS	(5) QTY INC IN UNIT	(6) 30-DAY DS MAINT ALLOWANCE			(7) 30-DAY GS MAINT ALLOWANCE			(8) 1 YR ALW PER EQUIP CATGCT	(9) DEPOT MAINT ALW PER 100 EQUIP	(10) ILLUSTRATIONS	
					(a) 1-20	(b) 21-50	(c) 51-100	(a) 1-20	(b) 21-50	(c) 51-100			(a) FIG NO.	(b) ITEM NO. OR REFERENCE DESIGNATION
M-H		INSULATION SLEEVING, ELECTRICAL TEFTW26B (81851)	FT	REF										
P-F	5340-282-1633	RING, RETAINING MS16633-1018 (96936)	EA	REF	*	*	*	*	*	*	*			
M-H		WIRE, ELECTRICAL 00702-1326 (70967)	FT	REF										
P-F		WASHER, FLAT 506-9911-003 (13499)	EA	1	*	*	*	*	*	*	*			
P-F	5340-090-4035	CLIP, RETAINING 502-6005-002 (13499)	EA	REF	*	*	*	*	*	*	*			
P-F		SPACER, SLEEVE 541-9979-002 (13499)	EA	REF	*	*	*	*	*	*	*			
P-F		SCREW, MACHINE P330-2290-000 (77250)	EA	REF	*	*	*	*	*	*	*			
M-E		WIRE, ELECTRICAL, WTE734ACW925 (90484)	FT	REF										
M-E		WIRE, ELECTRICAL WTE734ACW96 (90484)	FT	REF										
P-F	5305-055-7108	SCREW, CAPTIVE, SOCKETHEAD E2A440-4C3 (08664)	EA	REF	*	*	*	*	*	*	*			
P-F		SCREW, CAPTIVE 324-1682-070 (13499)	EA	REF	*	*	*	*	*	*	*			
P-F		SCREW, CAPTIVE SOCKET HEAD E2A440-4C3 (08664)	EA	REF	*	*	*	*	*	*	*			
P-F		SCREW, CAPTIVE 324-1682-060 (13499)	EA	REF	*	*	*	*	*	*	*			
P-F	5950-850-8716	CORE, ADJUSTABLE TUNING 288-0030-000 (13499)	EA	1	*	*	*	*	*	*	*	3-13	1A4A4E28	
M-D		PLATE, IDENTIFICATION 280-0450-000 (74048)	EA	11										
P-H	3010-788-5145	INSERT, FLEXIBLE 543-3192-003 (13499)	EA	1				*	*	*	*	3-3	1A4A4MP36	
P-H	5820-813-3433	COUPLING HALF, SHAFT 543-3066-002 (13499)	EA	1				*	*	*	*	3-3	1A4A4MP37	
P-H	5820-812-1968	COUPLING, HALF, SHAFT 543-3099-002 (13499)	EA	REF				*	*	*	*			
X1-H		COUPLING HALF, SHAFT 543-3193-003 (13499)	EA	REF										
P-F	5315-852-5329	PIN, GROOVED HEAD GP7-0933375-50 (73957)	EA	REF	*	*	*	*	*	*	*			
A-H-R		COVER, OSCILLATOR 544-9016-000 (13499)	EA	1										
X2-H		COVER-FREQUENCY GENERATOR 544-9018-005 (13499)	EA	1										
X2-H		COVER-FREQUENCY GENERATOR 544-9017-005 (13499)	EA	1										
X1-H		LATCH, RIM H4600-040-250 (83014)	EA	8										
X2-H		RIVET, TUBULAR R40081L-8CHROMATEX (12014)	EA	64										
P-H	5805-944-2707	HANDSET, HANGER 10471 (82872)	EA	1				*	*	*	*			
P-F	5305-653-2674	SCREW, MACHINE P347-0035-000 (77250)	EA	2	*	*	*	*	*	*	*			

SECTION III REPAIR PARTS FOR DIRECT SUPPORT, GENERAL SUPPORT, AND DEPOT MAINTENANCE (CONTINUED)

(1) SIR CODE	(2) FEDERAL STOCK NUMBER	(3) DESCRIPTION  USABLE ON CODE	(4) UNIT OF MEAS	(5) QTY INC IN UNIT	(6) 30-DAY DS MAINT ALLOWANCE			(7) 30-DAY GS MAINT ALLOWANCE			(8) 1 YR ALW PER EQUIP CATGCTY	(9) DEPOT MAINT ALW PER 100 EQUIP	(10) ILLUSTRATIONS	
					(a)	(b)	(c)	(a)	(b)	(c)			(a)	(b)
					1-20	21-50	51-100	1-20	21-50	51-100			FIG NO.	ITEM NO. OR REFERENCE DESIGNATION
P-F	5310-011-104	WASHER, LOCK MS35338-79 (96906)	EA	REF	*	*	*	*	*	*	*			
P-F		NUT, PLAIN, HEXAGON MS35699-64 (96906)	EA	REF	*	*	*	*	*	*	*			
A-F		GENERATOR, SIGNAL 542-7729-004 (13499)	EA	1									1A4A5	
P-F		WASHER, FLAT 310-0016-000 (13499)	EA	5	*	*	*	*	*	*	*			
M-H		INSULATION SLEEVING, ELECTRICAL MUL13190CIBALSIZEL6-0 (81349)	FT	1										
P-H		WASHER 506-9902-003 (13499)	EA	REF				*	*	*	*			
P-F	5305-770-253	SCREW, MACHINE MS51959-13 (96906)	EA	REF	*	*	*	*	*	*	*			
P-F	5305-770-2579	SCREW, MACHINE MS51959-15 (96906)	EA	4	*	*	*	*	*	*	*			
P-F	5305-77-6039	SCREW, MACHINE MS51959-12 (96906)	EA	REF	*	*	*	*	*	*	*			
P-F		SCREW, MACHINE F347-0091-000 (77250)	EA	5	*	*	*	*	*	*	*			
XI-F		WIRE, ELECTRICAL 00702-1324 (14018)	FT	REF										
M-H		CABLE, RADIO FREQUENCY RG196AV (80058)	FT	REF										
P-H		SCREW, SHIELD 542-7683-002 (13499)	EA	REF				*	*	*	*			
X2-H		PLATE, COVER 542-7696-003 (13499)	EA	REF										
P-F	5950-679-9450	COIL, RADIO FREQUENCY 542-7294-002 (13499)	EA	1	*	*	*	*	*	*	*	3-17	1A4A5LL	
P-H		CORE, ADJUSTABLE TUNER LS11-2W (71279)	EA	REF				*	*	*	*			
M-H		WIRE, ELECTRICAL 744PW (74116)	FT	REF										
X2-H		BLOCK, TUNING 543-3767-002 (13499)	EA	1										
X2-H		BRACKET, ANGLE 545-6150-002 (13499)	EA	1										
P-F		WASHER, LOCK 310-0396-000 (79807)	EA	4	*	*	*	*	*	*	*			
X2-H		PLATE, BASE 542-7298-002 (13499)	EA	1										
P-H		PIN, LOCATING 541-6556-002 (13499)	EA	REF				*	*	*	*			
X2-H		PLATE, BASE 542-7744-003 (13499)	EA	1										
X2-H		CASTING-PLATE 542-7744-013 (13499)	EA	1										
X2-H		FRAME, CHASSIS 542-7737-003 (13499)	EA	1										
P-H		BRACKET, SCREW 542-7769-002 (13499)	EA	REF				*	*	*	*			
X2-H	5320-117-6010	RIVET, SOLID MS20426AD2-3 (96906)	EA	REF										

SECTION III REPAIR PARTS FOR DIRECT SUPPORT, GENERAL SUPPORT, AND DEPOT MAINTENANCE (CONTINUED)

(1) SHR CODE	(2) FEDERAL STOCK NUMBER	(3) DESCRIPTION  REFERENCE NUMBER & MFR. CODE	(4) UNIT OF MEAS	(5) QTY INC IN UNIT	(6) 30-DAY DS MAINT ALLOWANCE			(7) 30-DAY GS MAINT ALLOWANCE			(8) 1 YR ALW PER EQUIP CONTACT	(9) DEPOT MAINT ALW PER 100 EQUIP	(10) ILLUSTRATIONS	
					(a)	(b)	(c)	(a)	(b)	(c)			(a)	(b)
					i-20	21-50	51-100	i-20	21-50	51-100			FIG NO.	ITEM NO. OR REFERENCE DESIGNATION
X2-H		FRAME, CHASSIS 542-7738-003 (13499)	EA	1										
X2-H		SHIELD, AIR-PRESSED 542-7748-003 (13499)	EA	1										
P-H	5310-141-1813	NUT, PLAIN, CLINCHED CL440-1C (46384)	EA	REF				*	*	*	*	*		
P-H		NUT, PLAIN CL440-1C (46384)	EA	REF				*	*	*	*	*		
P-F		NUT, PLAIN 542-7299-002 (13499)	EA	5	*	*	*	*	*	*	*	*		
X2-H		SHIELD, AIR 542-7749-003 (13499)	EA	1										
P-H	5820-987-3553	SIGNAL GENERATOR 547-3726-003 (13499)	EA	1				*	*	*	*	*		
M-H		INSULATION SLEEVING, ELECTRICAL TEFTW24-6 (81851)	FT	5										
M-H		INSULATION SLEEVING, ELECTRICAL TEFTW24-5 (81851)	FT	6										
M-H		INSULATION SLEEVING, ELECTRICAL TEFTW24-4 (81851)	FT	3										
P-H	5950-679-9451	COIL, RADIO FREQUENCY 526-6982-001 (13499)	EA	1				*	*	*	*	*	3-17	1A4A5L4
P-H		TERMINAL, LUG SPL4040-4HOTFINNED (77147)	EA	REF				*	*	*	*	*		
P-H		WASHER, LOCK 310-0395-000 (79807)	EA	5				*	*	*	*	*		
P-H	5305-957-7799	SCREW, MACHINE P343-0384-000 (77250)	EA	2				*	*	*	*	*		
P-H	5961-833-2249	TRANSISTOR 2N499 (07688)	EA	8				*	*	*	*	*	3-17	1A4A5Q5
P-H	5961-833-2249	TRANSISTOR 2N499 (07688)	EA	REF				*	*	*	*	*	3-17	1A4A5Q6
P-H	5961-833-2249	TRANSISTOR 2N499 (07688)	EA	REF				*	*	*	*	*	3-17	1A4A5Q7
P-H	5961-833-2249	TRANSISTOR 2N499 (07688)	EA	REF				*	*	*	*	*	3-17	1A4A5Q8
P-H	5961-833-2249	TRANSISTOR 2N499 (07688)	EA	REF				*	*	*	*	*	3-17	1A4A5Q9
P-H	5961-833-2249	TRANSISTOR 2N499 (07688)	EA	REF				*	*	*	*	*	3-17	1A4A5Q10
P-H	5961-833-2249	TRANSISTOR 2N499 (07688)	EA	REF				*	*	*	*	*	3-17	1A4A5Q11
P-H	5961-833-2249	TRANSISTOR 2N499 (07688)	EA	REF				*	*	*	*	*	3-17	1A4A5Q12
P-H	5961-023-2701	TRANSISTOR 2N264 (07688)	EA	1				*	*	*	*	*	3-17	1A4A5Q13
X1-H		WIRE, ELECTRICAL 00702-1324 (14018)	FT	REF										
A-H		SIGNAL GENERATOR 544-5649-003 (13499)	EA	1										
P-H	5950-387-0489	COIL, RADIO FREQUENCY DMO073 (99800)	EA	2				*	*	*	*	*	3-17	1A4A5L2
P-H	5950-387-0489	COIL, RADIO FREQUENCY DMO073 (99800)	EA	REF				*	*	*	*	*	3-17	1A4A5L3



SECTION III REPAIR PARTS FOR DIRECT SUPPORT, GENERAL SUPPORT, AND DEPOT MAINTENANCE (CONTINUED)

(1) SYM CODE	(2) FEDERAL STOCK NUMBER	(3) DESCRIPTION  REFERENCE NUMBER & MFR. CODE	(4) UNIT OF MEAS	(5) QTY INC IN UNIT	(6) 30-DAY OS MAINT ALLOWANCE			(7) 30-DAY GS MAINT ALLOWANCE			(8) 1 YR ALW PER EQUIP CNTGTY	(9) DEPOT MAINT ALW PER 100 EQUIP	(10) ILLUSTRATIONS	
					(a) 1-20	(b) 21-50	(c) 51-100	(a) 1-20	(b) 21-50	(c) 51-100			(a) FIG NO.	(b) ITEM NO. OR REFERENCE DESIGNATION
P-F	5950-647-9291	COIL, RADIO FREQUENCY 18-119 (09290)	EA	1	*	*	*	*	*	*	*	*	3-17	1A4A5L7
P-H	5950-655-0844	COIL, RADIO FREQUENCY L77E209 (81349)	EA	1				*	*	*	*	*	3-17	1A4A5L5
P-H	5950-594-1217	COIL, RADIO FREQUENCY 18-124 (09240)	EA	1				*	*	*	*	*	3-17	1A4A5L6
P-H	5999-790-4082	PRINTED CIRCUIT BOARD 544-5644-004 (13499)	EA	1				*	*	*	*	*	3-17	1A4A5E15
XI-H		PRINTED CIRCUIT BOARD 544-5647-004 (13499)	EA	1										
X2-H		EYELET, METALLIC A1444HOTTINNED (57771)	EA	REF										
XI-H		EYELET, METALLIC 542-0810-003 (13499)	EA	REF										
P-H		TERMINAL, STUD 542-4085-002 (13499)	EA	REF				*	*	*	*	*		
XI-H		CLIP, SPRING 542-7767-002 (13499)	EA	1										
XI-H		EYELET, METALLIC SE24CADEL (90030)	EA	REF										
X2-H		EYELET, METALLIC 542-0811-003 (13499)	EA	REF										
P-H	5905-283-6941	RESISTOR, FIXED, WIREWOUND RS5-75000G (91637)	EA	1				*	*	*	*	*	3-17	1A4A5R29
P-F	5905-195-6806	RESISTOR, FIXED, COMPOSITION RC20GF102K (81349)	EA	3	*	*	*	*	*	*	*	*	3-17	1A4A5R17
P-F	5905-195-6806	RESISTOR, FIXED, COMPOSITION RC20GF102K (81349)	EA	REF	*	*	*	*	*	*	*	*	3-17	1A4A5R25
P-F	5905-195-6806	RESISTOR, FIXED, COMPOSITION RC20GF102K (81349)	EA	REF	*	*	*	*	*	*	*	*	3-17	1A4A5R39
P-H		RESISTOR, FIXED, COMPOSITION RC20GF102J (81349)	EA	1				*	*	*	*	*	3-17	1A4A5R30
P-F	5905-171-2009	RESISTOR, FIXED, COMPOSITION RC20GF222K (81349)	EA	1	*	*	*	*	*	*	*	*	3-17	1A4A5R37
P-H	5905-110-0310	RESISTOR, FIXED, COMPOSITION RC20GF472J (81349)	EA	1				*	*	*	*	*	3-17	1A4A5R28
P-H	59505-195-6451	RESISTOR, FIXED, COMPOSITION RC20GF472K (81349)	EA	8				*	*	*	*	*	3-17	1A4A5R13
P-H	59505-195-6451	RESISTOR, FIXED, COMPOSITION RC20GF472K (81349)	EA	REF				*	*	*	*	*	3-17	1A4A5R15
P-H	59505-195-6451	RESISTOR, FIXED, COMPOSITION RC20GF472K (81349)	EA	REF				*	*	*	*	*	3-17	1A4A5R18
P-H	59505-195-6451	RESISTOR, FIXED, COMPOSITION RC20GF472K (81349)	EA	REF				*	*	*	*	*	3-17	1A4A5R23
P-H	59505-195-6451	RESISTOR, FIXED, COMPOSITION RC20GF472K (81349)	EA	REF				*	*	*	*	*	3-17	1A4A5R26
P-H	59505-195-6451	RESISTOR, FIXED, COMPOSITION RC20GF472K (81349)	EA	REF				*	*	*	*	*	3-17	1A4A5R31
P-H	59505-195-6451	RESISTOR, FIXED, COMPOSITION RC20GF472K (81349)	EA	REF				*	*	*	*	*	3-17	1A4A5R33
P-H	59505-195-6451	RESISTOR, FIXED, COMPOSITION RC20GF472K (81349)	EA	REF				*	*	*	*	*	3-17	1A4A5R35
P-F	5905-141-0591	RESISTOR, FIXED, COMPOSITION 543-1589-002 (13499)	EA	1	*	*	*	*	*	*	*	*	3-17	1A4A5R38

SECTION III REPAIR PARTS FOR DIRECT SUPPORT, GENERAL SUPPORT, AND DEPOT MAINTENANCE (CONTINUED)

(1) SR CODE	(2) FEDERAL STOCK NUMBER	(3) DESCRIPTION  REFERENCE NUMBER & MFR. CODE	(4) UNIT OF MEAS	(5) QTY INC IN UNIT	(6) 30-DAY DS MAINT ALLOWANCE			(7) 30-DAY GS MAINT ALLOWANCE			(8) 1 YR ALW PER EQUIP CNTGCT	(9) DEPOT MAINT ALW PER 100 EQUIP	(10) ILLUSTRATIONS	
					(a)	(b)	(c)	(a)	(b)	(c)			(a)	(b)
					1-20	21-50	51-100	1-20	21-50	51-100			FIG NO.	ITEM NO. OR REFERENCE DESIGNATION
P-H	5905-190-8882	RESISTOR, FIXED, COMPOSITION RC20GF393K (81349)	EA	3				*	*	*	*	*	3-17	1A4A5R14
P-H	5905-190-8882	RESISTOR, FIXED, COMPOSITION RC20GF393K (81349)	EA	REF				*	*	*	*	*	3-17	1A4A5R16
P-H	5905-190-8882	RESISTOR, FIXED, COMPOSITION RC20GF393K (81349)	EA	REF				*	*	*	*	*	3-17	1A4A5R24
P-H	5905-192-3987	RESISTOR, FIXED, COMPOSITION RC20GF104K (81349)	EA	3				*	*	*	*	*	3-17	1A4A5R19
P-H	5905-192-3987	RESISTOR, FIXED, COMPOSITION RC20GF104K (81349)	EA	REF				*	*	*	*	*	3-17	1A4A5R27
P-H	5905-192-3987	RESISTOR, FIXED, COMPOSITION RC20GF104K (81349)	EA	REF				*	*	*	*	*	3-17	1A4A5R32
P-H	5905-192-0667	RESISTOR, FIXED, COMPOSITION RC20GF224K (81349)	EA	1				*	*	*	*	*	3-17	1A4A5R34
XI-H		CAPACITOR, FIXED, MICA DIELECTRIC 22H5Q3D0 (14655)	EA	1									3-17	1A4A5C24
P-H	5910-860-7747	CAPACITOR, FIXED, CERAMIC DIELECTRIC CC33PG820F (81349)	EA	1				*	*	*	*	*	3-17	1A4A5C3
P-H	5910-717-0169	CAPACITOR, FIXED, MICA DIELECTRIC 22H5T1EG (14655)	EA	6				*	*	*	*	*	3-17	1A4A5C6
P-H	5910-717-0169	CAPACITOR, FIXED, MICA DIELECTRIC 22H5T1EG (14655)	EA	REF				*	*	*	*	*	3-17	1A4A5C8
P-H	5910-717-0169	CAPACITOR, FIXED, MICA DIELECTRIC 22H5T1EG (14655)	EA	REF				*	*	*	*	*	3-17	1A4A5C12
P-H	5910-717-0169	CAPACITOR, FIXED, MICA DIELECTRIC 22H5T1EG (14655)	EA	REF				*	*	*	*	*	3-17	1A4A5C25
P-H	5910-717-0169	CAPACITOR, FIXED, MICA DIELECTRIC 22H5T1EG (14655)	EA	REF				*	*	*	*	*	3-17	1A4A5C28
P-H	5910-717-0169	CAPACITOR, FIXED, MICA DIELECTRIC 22H5T1EG (14655)	EA	REF				*	*	*	*	*	3-17	1A4A5C33
P-H	5910-766-8790	CAPACITOR, FIXED, MICA DIELECTRIC 22H5T13EG (14655)	EA	1				*	*	*	*	*	3-17	1A4A5C9
P-H	5910-725-1993	CAPACITOR, FIXED, MICA DIELECTRIC 22H5T2EG (14655)	EA	1				*	*	*	*	*	3-17	1A4A5C15
M-H		INSULATION SLEEVING, ELECTRICAL TEFTW2-3 (81851)	FT	REF										
P-H	5910-849-5725	CAPACITOR, FIXED, MICA DIELECTRIC CY16C102J (81349)	EA	9				*	*	*	*	*	3-17	1A4A5C1
P-H	5910-849-5725	CAPACITOR, FIXED, MICA DIELECTRIC CY16C102J (81349)	EA	REF				*	*	*	*	*	3-17	1A4A5C4
P-H	5910-849-5725	CAPACITOR, FIXED, MICA DIELECTRIC CY16C102J (81349)	EA	REF				*	*	*	*	*	3-17	1A4A5C7
P-H	5910-849-5725	CAPACITOR, FIXED, MICA DIELECTRIC CY16C102J (81349)	EA	REF				*	*	*	*	*	3-17	1A4A5C10
P-H	5910-849-5725	CAPACITOR, FIXED, MICA DIELECTRIC CY16C102J (81349)	EA	REF				*	*	*	*	*	3-17	1A4A5C13
P-H	5910-849-5725	CAPACITOR, FIXED, MICA DIELECTRIC CY16C102J (81349)	EA	REF				*	*	*	*	*	3-17	1A4A5C14
P-H	5910-849-5725	CAPACITOR, FIXED, MICA DIELECTRIC CY16C102J (81349)	EA	REF				*	*	*	*	*	3-17	1A4A5C16
P-H	5910-849-5725	CAPACITOR, FIXED, MICA DIELECTRIC CY16C102J (81349)	EA	REF				*	*	*	*	*	3-17	1A4A5C32
P-H	5910-849-5725	CAPACITOR, FIXED, MICA DIELECTRIC CY16C102J (81349)	EA	REF				*	*	*	*	*	3-17	1A4A5C36

SECTION III REPAIR PARTS FOR DIRECT SUPPORT, GENERAL SUPPORT, AND DEPOT MAINTENANCE (CONTINUED)

(1) SRC CODE	(2) FEDERAL STOCK NUMBER	(3) DESCRIPTION  REFERENCE NUMBER & MFR. CODE	(4) UNIT OF MEAS	(5) QTY INC IN UNIT	(6) 30-DAY DS MAINT ALLOWANCE			(7) 30-DAY GS MAINT ALLOWANCE			(8) 1 YR ALW PER EQUIP CWTGCT	(9) DEPOT MAINT ALW PER 100 EQUIP	(10) ILLUSTRATIONS	
					(a) 1-20	(b) 21-50	(c) 51-100	(a) 1-20	(b) 21-50	(c) 51-100			(a) FIG NO.	(b) ITEM NO. OR REFERENCE DESIGNATION
					P-H	5910-849-527	CAPACITOR, FIXED, MICA DIELECTRIC CY16C681J (81349)	EA	3					
P-H	5910-849-527	CAPACITOR, FIXED, MICA DIELECTRIC CY16C681J (81349)	EA	REF				*	*	*	*	*	3-17	1A4A5C29
P-H	5910-849-527	CAPACITOR, FIXED, MICA DIELECTRIC CY16C681J (81349)	EA	REF				*	*	*	*	*	3-17	1A4A5C34
P-H	5910-280-9297	CAPACITOR, FIXED, PAPER DIELECTRIC SDB1K01103 (53021)	EA	2				*	*	*	*	*	3-17	1A4A5C22
P-H	5910-583-1953	CAPACITOR, FIXED, ELECTROLYTIC 112D506C7050J1 (56289)	EA	1				*	*	*	*	*	3-17	1A4A5C21
P-H	5910-850-0541	CAPACITOR, FIXED, MICA DIELECTRIC 2ZHSQ47DG (14655)	EA	1				*	*	*	*	*	3-17	1A4A5C31
XL-H		WIRE, ELECTRICAL 00702-1324 (14018)	FT	REF										
M-H		INSULATION SLEEVING, ELECTRICAL TEFTW24-5 (81851)	FT	REF										
P-H	5905-190-8879	RESISTOR, FIXED, COMPOSITION RC20GF183K (81349)	EA	1				*	*	*	*	*	3-17	1A4A5R36
P-H	5910-683-7985	CAPACITOR, VARIABLE 557043U2P034R (72982)	EA	4				*	*	*	*	*	3-17	1A4A5C11
P-H	5910-683-7985	CAPACITOR, VARIABLE 557043U2P034R (72982)	EA	REF				*	*	*	*	*	3-17	1A4A5C17
P-H	5910-683-7985	CAPACITOR, VARIABLE 557043U2P034R (72982)	EA	REF				*	*	*	*	*	3-17	1A4A5C26
P-H	5910-683-7985	CAPACITOR, VARIABLE 557043U2P034R (72982)	EA	REF				*	*	*	*	*	3-17	1A4A5C30
P-H	5961-779-3241	SEMICONDUCTOR DEVICE, DIODE 1N721A (07688)	EA	1				*	*	*	*	*		1A4A5CR3
P-H	5910-816-8410	CAPACITOR, FIXED, PAPER DIELECTRIC SDB1K01822K (53021)	EA	1				*	*	*	*	*	3-17	1A4A5C37
P-H	5910-082-4893	CAPACITOR, FIXED, CERAMIC DIELECTRIC CK13AX332M (81349)	EA	2				*	*	*	*	*	3-17	1A4A5C23
P-H	5910-082-4893	CAPACITOR, FIXED, CERAMIC DIELECTRIC CK13AX332M (81349)	EA	REF				*	*	*	*	*	3-17	1A4A5C27
A-H		SIGNAL REFERENCE GENERATOR 542-7766-004 (13499)	EA	1										
M-H		INSULATION SLEEVING, ELECTRICAL TEFTW20-2 (81851)	FT	1										
M-H		INSULATION SLEEVING, ELECTRICAL TEFTW20-1 (81851)	FT	1										
M-H		INSULATION SLEEVING, ELECTRICAL TEFTW20-0 (81851)	FT	1										
M-H		INSULATION SLEEVING, ELECTRICAL TEFTW20-4 (81851)	FT	1										
P-H	5961-883-5305	TRANSISTOR 2N527 (07688)	EA	1				*	*	*	*	*	3-17	1A4A5Q3
M-H		INSULATION SLEEVING, ELECTRICAL TEFTW19-2 (81851)	FT	1										
M-H		INSULATION SLEEVING, ELECTRICAL TEFTW19-4 (81851)	FT	1										
P-H	5910-952-9257	CAPACITOR, FIXED, ELECTROLYTIC CL27B6200UN3 (81349)	EA	2				*	*	*	*	*	3-17	1A4A5C18
P-H	5910-952-9275	CAPACITOR, FIXED, ELECTROLYTIC CL27B6200UN3 (81349)	EA	REF				*	*	*	*	*	3-17	1A4A5C19

SECTION III REPAIR PARTS FOR DIRECT SUPPORT, GENERAL SUPPORT, AND DEPOT MAINTENANCE (CONTINUED)

(1) SIR CODE	(2) FEDERAL STOCK NUMBER	(3) DESCRIPTION  REFERENCE NUMBER & MFR. CODE	(4) UNIT OF MEAS	(5) QTY INC IN UNIT	(6) 30-DAY DS MAINT ALLOWANCE			(7) 30-DAY GS MAINT ALLOWANCE			(8) 1 YR ALW PER EQUIP CNTGCT	(9) DEPOT MAINT ALW PER 100 EQUIP	(10) ILLUSTRATIONS	
					(a) 1-20	(b) 21-50	(c) 51-100	(a) 1-20	(b) 21-50	(c) 51-100			(a) FIG NO.	(b) ITEM NO. OR REFERENCE DESIGNATION
M-H		INSULATION SLEEVING, ELECTRICAL 3003TEMPLEX105CLR5-16IN (75037)	FT	1										
P-H	5930-726-2067	SWITCH, THERMOSTATIC 32400-0-140 (73168)	EA	1				*	*	*	*	*	3-17	1A4A5CB1
P-H	5961-837-1924	SEMICONDUCTOR DEVICE, DIODE 1N91 (07688)	EA	2				*	*	*	*	*	3-17	1A4A5CR1
P-H	5961-837-1924	SEMICONDUCTOR DEVICE, DIODE 1N91 (07688)	EA	REF				*	*	*	*	*		1A4A5CR2
P-F	5305-054-5647	SCREW, MACHINE MS51957-30 (96906)	EA	REF	*	*	*	*	*	*	*	*		
P-F		NUT, PLAIN, HEXAGON P313-0045-000 (77250)	EA	REF	*	*	*	*	*	*	*	*		
P-F	5310-934-9748	NUT, PLAIN, HEXAGON MS35649-44 (96906)	EA	REF	*	*	*	*	*	*	*	*		
P-F	5310-042-9609	WASHER, LOCK MS35338-78 (96906)	EA	REF	*	*	*	*	*	*	*	*		
P-F	5310-011-1041	WASHER, LOCK MS35338-79 (96906)	EA	REF	*	*	*	*	*	*	*	*		
XL-H		WIRE, ELECTRICAL 00702-1324 (14018)	FT	REF										
M-H		WIRE, ELECTRICAL WTE734ACW2 (90484)	FT	REF										
M-H		WIRE, ELECTRICAL WTE734ACW4 (90484)	FT	2										
M-H		WIRE, ELECTRICAL WTE734ACW5 (90484)	FT	REF										
M-H		WIRE, ELECTRICAL WTE734ACW6 (90484)	FT	REF										
X2-H		BRACKET, CIRCUIT 542-7760-004 (13499)	EA	1										
X2-H		BRACKET, CIRCUIT 542-7779-004 (13499)	EA	1										
P-F	5940-782-8942	TERMINAL, FEEDTHRU FTSML (98291)	EA	6	*	*	*	*	*	*	*	*	3-17	1A4A5E1
P-F	5940-782-8942	TERMINAL, FEEDTHRU FTSML (98291)	EA	REF	*	*	*	*	*	*	*	*	3-17	1A4A5E3
P-F	59470-782-8942	TERMINAL, FEEDTHRU FTSML (98291)	EA	REF	*	*	*	*	*	*	*	*	3-17	1A4A5E4
P-F	5940-782-8942	TERMINAL, FEEDTHRU FTSML (98291)	EA	REF	*	*	*	*	*	*	*	*	3-17	1A4A5E7
P-F	590-782-8942	TERMINAL, FEEDTHRU FTSML (98291)	EA	REF	*	*	*	*	*	*	*	*	3-17	1A4A5E9
P-F	5940-782-8942	TERMINAL, FEEDTHRU FTSML (98291)	EA	REF	*	*	*	*	*	*	*	*	3-17	1A4A5E10
P-F		TERMINAL, STUD 2691A (12615)	EA	8	*	*	*	*	*	*	*	*	3-17	1A4A5E2
P-F		TERMINAL, STUD 2691A (12615)	EA	REF	*	*	*	*	*	*	*	*	3-17	1A4A5E5
P-F		TERMINAL, STUD 2691A (12615)	EA	REF	*	*	*	*	*	*	*	*	3-17	1A4A5E6
P-F		TERMINAL, STUD 2691A (12615)	EA	REF	*	*	*	*	*	*	*	*	3-17	1A4A5E8
P-F		TERMINAL, STUD 2691A (12615)	EA	REF	*	*	*	*	*	*	*	*	3-17	1A4A5E11

SECTION III REPAIR PARTS FOR DIRECT SUPPORT, GENERAL SUPPORT, AND DEPOT MAINTENANCE (CONTINUED)

(1) SMB CODE	(2) FEDERAL STOCK NUMBER	(3) DESCRIPTION  USABLE ON CODE	(4) UNIT OF MEAS	(5) QTY INC IN UNIT	(6) 30-DAY DS MAINT ALLOWANCE			(7) 30-DAY GS MAINT ALLOWANCE			(8) 1 YR ALW PER EQUIP (WTGCT)	(9) DEPOT MAINT ALW PER 100 EQUIP	(10) ILLUSTRATIONS	
					(a)	(b)	(c)	(a)	(b)	(c)			(a)	(b)
					1-20	21-50	51-100	1-20	21-50	51-100			FIG NO.	ITEM NO. OR REFERENCE DESIGNATION
P-F	5940-782-8942	TERMINAL, STUD 2691A (12615)	EA	REF	*	*	*	*	*	*	*	3-17	1A4A5E12	
P-F	5940-782-8942	TERMINAL, STUD 2691A (12615)	EA	REF	*	*	*	*	*	*	*	3-17	1A4A5E13	
P-F	5940-782-8942	TERMINAL, STUD 2691A (12615)	EA	REF	*	*	*	*	*	*	*	3-17	1A4A5E14	
P-H	5310-063-6458	NUT, FLAIN, CLINCHED CL440-2C (46384)	EA	6	*	*	*	*	*	*	*			
P-H	5950-645-5866	TRANSFORMER, AUDIO FREQUENCY 24545 (80089)	EA	1	*	*	*	*	*	*	*	3-17	1A4A5T1	
P-H	5950-615-4792	TRANSFORMER, AUDIO FREQUENCY 24544 (80089)	EA	1	*	*	*	*	*	*	*	3-17	1A4A5T3	
P-H	5950-583-0966	TRANSFORMER, AUDIO FREQUENCY W8309 (80223)	EA	1	*	*	*	*	*	*	*	3-17	1A4A5T2	
P-H	5905-577-7427	RESISTOR, FIXED, WIREWOUND RW59V100 (81349)	EA	2	*	*	*	*	*	*	*	3-17	1A4A5R7	
P-H	5905-577-7427	RESISTOR, FIXED, WIREWOUND RW59V100 (81349)	EA	REF	*	*	*	*	*	*	*	3-17	1A4A5R8	
P-H	5905-171-2002	RESISTOR, FIXED, COMPOSITION RC20GF470K (81349)	EA	1	*	*	*	*	*	*	*	3-17	1A4A5R5	
P-F	5905-141-0591	RESISTOR, FIXED, COMPOSITION RC20GF103K (81349)	EA	1	*	*	*	*	*	*	*	3-17	1A4A5R20	
P-H	5905-195-6453	RESISTOR, FIXED, COMPOSITION RC20GF562K (81349)	EA	1	*	*	*	*	*	*	*	3-17	1A4A5R22	
P-H	5905-247-8710	RESISTOR, FIXED, COMPOSITION RC32GF220K (81349)	EA	1	*	*	*	*	*	*	*	3-17	1A4A5R1	
P-H	5905-081-6137	RESISTOR, FIXED, WIREWOUND RS2CS000J (91637)	EA	1	*	*	*	*	*	*	*	3-17	1A4A5R6	
P-H	5910-542-7551	CAPACITOR, FIXED, PAPER DIELECTRIC SDBLK01475J (93021)	EA	1	*	*	*	*	*	*	*	3-17	1A4A5C2	
P-H	5325-703-1999	HOLDER, TRANSISTOR A51043 (08289)	EA	1	*	*	*	*	*	*	*			
P-H	5905-141-0595	RESISTOR, FIXED, COMPOSITION RC20GF472K (81349)	EA	1	*	*	*	*	*	*	*	3-17	1A4A5R3	
A-H		RADIATOR ASSEMBLY 542-7293-002 (13499)	EA	1										
P-H	5961-581-9888	TRANSISTOR 2N540 (07688)	EA	3	*	*	*	*	*	*	*	3-17	1A4A5Q1	
P-H	5961-581-9888	TRANSISTOR 2N540 (07688)	EA	REF	*	*	*	*	*	*	*	3-17	1A4A5Q2	
P-H	5961-581-9888	TRANSISTOR 2N540 (07688)	EA	REF	*	*	*	*	*	*	*	3-17	1A4A5Q4	
P-H		BUSHING, RADIATOR 542-7285-002 (13499)	EA	3	*	*	*	*	*	*	*			
X2-H		RADIATOR, TRANSISTOR 542-0740-003 (13499)	EA	1										
X2-H		RADIATOR-CASTING 542-0740-013 (13499)	EA	1										
P-H		WASHER 542-7292-002 (13499)	EA	6	*	*	*	*	*	*	*			
P-H		WASHER, FLAT 310-0058-000 (79807)	EA	3	*	*	*	*	*	*	*			
X2-H		COVER, RADIATOR 542-7283-002 (13499)	EA	1										

AMBL:44

TM 11-5820-555-24P  
SECTION III REPAIR PARTS FOR DIRECT SUPPORT, GENERAL SUPPORT, AND DEPOT MAINTENANCE (CONTINUED)

(1) SIR CODE	(2) FEDERAL STOCK NUMBER	(3) DESCRIPTION  REFERENCE NUMBER & MFR. CODE	(4) UNIT OF MEAS	(5) QTY INC IN UNIT	(6) 30-DAY DS MAINT ALLOWANCE			(7) 30-DAY GS MAINT ALLOWANCE			(8) 1 YR ALW PER EQUIP CHNGCY	(9) DEPOT MAINT ALW PER 100 EQUIP	(10) ILLUSTRATIONS	
					(a) 1-20	(b) 21-50	(c) 51-100	(a) 1-20	(b) 21-50	(c) 51-100			(a) FIG NO.	(b) ITEM NO. OR REFERENCE DESIGNATION
P-H		SCREW, MACHINE P347-0103-000 (77250)	EA	2				*	*	*	*			
P-F	5905-245-0023	RESISTOR, FIXED, COMPOSITION RC20GF682K (81349)	EA	1	*	*	*	*	*	*	*	3-17	1A4A5R4	
P-H	5905-195-6741	RESISTOR, FIXED, COMPOSITION RC20GF272K (81349)	EA	1				*	*	*	*	3-17	1A4A5R21	
P-F	5905-106-9344	RESISTOR, FIXED, COMPOSITION RC20GF101J (81349)	EA	1	*	*	*	*	*	*	*	3-17	1A4A5R2	
M-H		INSULATION SLEEVING, ELECTRICAL TEFTW20-6 (81851)	FT	1										
M-H		INSULATION SLEEVING, ELECTRICAL TEFTW20-5 (81851)	FT	1										
P-F	5905-171-2009	RESISTOR, FIXED, COMPOSITION RC20GF222K (81349)	EA	1	*	*	*	*	*	*	*		1A4A5R4C	
X2-H		FLASK-MOLDED 542-7753-003 (13499)	EA	1										
X2-H		FLASK, DEWAR DEM99803554 (14674)	EA	1										
X2-H		PLATE, MOUNTING 542-7305-002 (13499)	EA	1										
X2-H		PLATE, MOUNTING 542-7306-002 (13499)	EA	1										
P-H		NUT, FLAIN 542-7304-002 (13499)	EA	4				*	*	*	*			
X2-H		PLATE, MOUNTING 542-7302-002 (13499)	EA	1										
X2-H		PLATE, MOUNTING 542-7303-002 (13499)	EA	1										
P-H		NUT, FLAIN 542-7304-002 (13499)	EA	REF				*	*	*	*			
M-H		MARCOFOAM SK115 (88252)	EA	V										
P-K	5955-679-9449	OVEN, CRYSTAL 542-7288-002 (13499)	EA	1				*	*	*	*	3-17	1A4A5HR1	
XI-H		CRYSTAL UNIT, QUARTZ 290-5430-000 (71054)	EA	1								3-17	1A4A5Y1	
XI-H		TERMINAL, LUG 4040-2HOTTTINED (77447)	EA	4										
P-H	5305-054-5636	SCREW, MACHINE MS51957-2 (96906)	EA	REF				*	*	*	*			
XI-H		INSERT, OVEN 542-7289-002 (13499)	EA	1										
XI-H		PLUG, RETAINING 542-7307-002 (13499)	EA	3										
XI-H		MARCOFOAM SK116 (88252)	EA	REF										
XI-H		PLUG, FLASK 542-7308-002 (13499)	EA	1										
P-F	5305-370-2533	SCREW, MACHINE MS51959-13 (96906)	EA	REF	*	*	*	*	*	*	*			
XI-H		POST, SPACING 542-7309-002 (13499)	EA	1										
XI-H		SOCKET, CRYSTAL 542-7310-002 (13499)	EA	1										

TM11-5820-555-24P  
SECTION III REPAIR PARTS FOR DIRECT SUPPORT, GENERAL SUPPORT, AND DEPOT MAINTENANCE (CONTINUED)

(1) S&P CODE	(2) FEDERAL STOCK NUMBER	(3) DESCRIPTION  REFERENCE NUMBER & MFR. CODE	(4) UNIT OF MEAS	(5) QTY INC IN UNIT	(6) 30-DAY DS MAINT ALLOWANCE			(7) 30-DAY GS MAINT ALLOWANCE			(8) 1 YR ALW PER EQUIP CTGCT	(9) DEPOT MAINT ALW PER 100 EQUIP	(10) ILLUSTRATIONS	
					(a) 1-20	(b) 21-50	(c) 51-100	(a) 1-20	(b) 21-50	(c) 51-100			(a) FIG NO.	(b) ITEM NO. OR REFERENCE DESIGNATION
XI-H		JACK, TIP SKT4 (90484)	EA	2										
XI-H		SOCKET, CRYSTAL 542-7311-002 (13499)	EA	1										
XI-H		CABLE, SPECIAL 542-7313-002 (13499)	EA	1										
M-H		WIRE, ELECTRICAL WTE734ACW4 (90484)	FT	REF										
M-H		WIRE, ELECTRICAL WTE734ACW5 (90484)	FT	REF										
M-H		BRAID, WIRE 36062 (79818)	FT	REF										
XI-H		CABLE ASSEMBLY 542-7750-003 (13499)	EA	1										
XI-H		WIRE, ELECTRICAL WTE734ACW7 (90484)	FT	1										
M-H		WIRE, ELECTRICAL WTE734ACW9 (90484)	FT	REF										
M-H		WIRE, ELECTRICAL WTE734ACW5 (90484)	FT	REF										
M-H		WIRE, ELECTRICAL WTE734ACW1 (90484)	FT	REF										
M-H		INSULATION SLEEVING, ELECTRICAL XF12BL (81851)	FT	REF										
XI-H		GROMMET, RUBBER MS39489-1 (96906)	EA	6										
XI-H		CABLE, SPECIAL PURPOSE, ELECTRICAL MILW16878TYPEC22-9 (81349)	FT	1										
XI-H		LOCKFOAM KIT F403 (88252)	EA	V										
XI-H		BUMPER, PLASTIC 542-7312-002 (13499)	EA	1										
M-H		NORCOFOAM SX116 (88252)	EA	REF										
XI-H		CAN, OVEN 542-7754-003 (13499)	EA	1										
XI-H		WIRE, ELECTRICAL 431-0252-000 (13499)	FT	35										
XI-H		RESISTANCE WIRE 431-0292-000 (13499)	FT	35										
XI-H		STRIP, INSULATION 542-7314-002 (13499)	EA	1										
XI-H		PLATE, ELECTRICAL SHIELD 542-7315-002 (13499)	EA	1										
XI-H		CAN, OVEN-PRESSED 542-7316-002 (13499)	EA	1										
P-F		TERMINAL, STUD 2619A (12615)	EA	REF	*	*	*	*	*	*	*	*	*	
XI-H		CAN, OVEN 542-7317-002 (13499)	EA	1										
P-F	5310-058-3829	WASHER, LOCK MS35338-77 (96906)	EA	REF	*	*	*	*	*	*	*	*	*	
P-F	5310-595-5421	WASHER, FLAT 310-6320-000 (79807)	EA	REF	*	*	*	*	*	*	*	*	*	

SECTION III REPAIR PARTS FOR DIRECT SUPPORT, GENERAL SUPPORT, AND DEPOT MAINTENANCE (CONTINUED)

(1) SIR CODE	(2) FEDERAL STOCK NUMBER	(3) DESCRIPTION  REFERENCE NUMBER & MFR. CODE	(4) UNIT OF MEAS	(5) QTY INC IN UNIT	(6) 30-DAY DS MAINT ALLOWANCE			(7) 30-DAY GS MAINT ALLOWANCE			(8) 1 YR ALW PER EQUIP CRNCY	(9) DEPOT MAINT ALW PER 100 EQUIP	(10) ILLUSTRATIONS	
					(a)	(b)	(c)	(a)	(b)	(c)			(a) FIG NO.	(b) ITEM NO. OR REFERENCE DESIGNATION
					1-20	21-50	51-100	1-20	21-50	51-100				
P-H	5830-021-0823	PLATE, COVER 542-7757-003 (13499)	EA	1	*	*	*	*	*	*	*			
P-F	5910-683-7478	CAPACITOR; SELECT FROM CAPACITOR, FIXED, MICA DIELECTRIC 22H5T3EG (14655)	EA	1	*	*	*	*	*	*	*	3-17	1A4A5C38	
P-F	5910-984-5253	-OR- CAPACITOR, FIXED, MICA DIELECTRIC 22H5T3EG (14655)	EA	1	*	*	*	*	*	*	*	3-17	1A4A5C38	
XI-F		-OR- CAPACITOR, FIXED, MICA DIELECTRIC 22H5T36EG (14655)	EA	1								3-17	1A4A5C38	
P-F	5910-663-5572	-OR- CAPACITOR, FIXED, MICA DIELECTRIC 22H5T39EG (14655)	EA	1	*	*	*	*	*	*	*	3-17	1A4A5C38	
P-H	5910-728-1577	-OR- CAPACITOR, FIXED, MICA DIELECTRIC 22H5T43EG (14655)	EA	1	*	*	*	*	*	*	*	3-17	1A4A5C38	
P-F	5910-762-2945	-OR- CAPACITOR, FIXED, MICA DIELECTRIC 22H5T47EG (14655)	EA	1	*	*	*	*	*	*	*	3-17	1A4A5C38	
P-F	5910-060-9619	-OR- CAPACITOR, FIXED, MICA DIELECTRIC 22H5T51EG (14655)	EA	1	*	*	*	*	*	*	*	3-17	1A4A5C38	
P-H	5910-849-5727	-OR- CAPACITOR, FIXED, MICA DIELECTRIC CY16C681J (81349)	EA	1	*	*	*	*	*	*	*	3-17	1A4A5C38	
M-H		INSULATION SLEEVING, ELECTRICAL TEFTW24-3 (81851)	FT	4										
P-F	5910-079-5253	CAPACITOR; SELECT FROM CAPACITOR, FIXED, MICA DIELECTRIC DM30F472G03 (81349)	EA	1	*	*	*	*	*	*	*	3-17	1A4A5C20	
P-F	5910-082-4898	-OR- CAPACITOR, FIXED, MICA DIELECTRIC DM30F512K03 (72136)	EA	1	*	*	*	*	*	*	*	3-17	1A4A5C20	
P-F	5910-771-9090	-OR- CAPACITOR, FIXED, MICA DIELECTRIC DM30F562K03 (72136)	EA	1	*	*	*	*	*	*	*	3-17	1A4A5C20	
P-F	5910-777-6922	-OR- CAPACITOR, FIXED, MICA DIELECTRIC DM30F622K03 (72136)	EA	1	*	*	*	*	*	*	*	3-17	1A4A5C20	
P-F	5910-043-2939	-OR- CAPACITOR, FIXED, MICA DIELECTRIC DM30F682K03 (72136)	EA	1	*	*	*	*	*	*	*	3-17	1A4A5C20	
P-F	5910-044-4036	-OR- CAPACITOR, FIXED, MICA DIELECTRIC DM30F752K03 (72136)	EA	1	*	*	*	*	*	*	*	3-17	1A4A5C20	
P-F	5910-765-6223	-OR- CAPACITOR, FIXED, MICA DIELECTRIC DM30F822K03 (72136)	EA	1	*	*	*	*	*	*	*	3-17	1A4A5C20	
P-F	5910-777-6907	-OR- CAPACITOR, FIXED, MICA DIELECTRIC DM30F912K03 (72136)	EA	1	*	*	*	*	*	*	*	3-17	1A4A5C20	
P-F	5910-777-6919	-OR- CAPACITOR, FIXED, MICA DIELECTRIC DM30F103K03 (72136)	EA	1	*	*	*	*	*	*	*	3-17	1A4A5C20	
XI-F		GROMMET, RUBBER MS35489-1 (96906)	EA	REF										
P-F		SCREW, MACHINE P347-0021-000 (77250)	EA	REF	*	*	*	*	*	*	*			
P-H		WASHER 504-0705-003 (13499)	EA	1				*	*	*	*			
M-H		INSULATION SLEEVING, ELECTRICAL TEFTW198 (81851)	FT	REF										
M-H		INSULATION SLEEVING, ELECTRICAL TEFTW19-2 (81851)	FT	REF										
X2-H		BLOCK, COIL 543-3766-002 (13499)	EA	1										
P-F	5821-676-2818	SLUB, TUNING 543-3768-002 (13499)	EA	1	*	*	*	*	*	*	*			
P-H		RING, RETAINING 5133-1BC (79136)	EA	1				*	*	*	*			



SECTION III REPAIR PARTS FOR DIRECT SUPPORT, GENERAL SUPPORT, AND DEPOT MAINTENANCE (CONTINUED)

(1) SR CODE	(2) FEDERAL STOCK NUMBER	(3) DESCRIPTION  REFERENCE NUMBER & MFR. CODE	(4) UNIT OF MEAS	(5) QTY INC IN UNIT	(6) 30-DAY DS MAINT ALLOWANCE			(7) 30-DAY GS MAINT ALLOWANCE			(8) 1 YR ALW PER EQUIP CNTGTY	(9) DEPOT MAINT ALW PER 100 EQUIP	(10) ILLUSTRATIONS			
					USABLE ON CODE	REF	*	*	*	*			*	*	(a) FIG NO.	(b) ITEM NO. OR REFERENCE DESIGNATION
P-H		WASHER, FLAT 310-0054-000 (79807)	EA	REF				*	*	*	*	*				
P-F	5305-054-5647	SCREW, MACHINE MS51957-13 (96906)	EA	REF	*	*	*	*	*	*	*	*				
P-H		SHIM 547-1479-002 (13499)	EA	3				*	*	*	*	*				
P-H	5910-280-9297	CAPACITOR; SELECT FROM CAPACITOR, FIXED, PAPER DIELECTRIC SDBLKD1103J (53021) -OR-	EA	REF				*	*	*	*	*	3-17	1A4A5C35		
P-H	5923-553-7289	CAPACITOR, FIXED, PAPER DIELECTRIC SDBLKD2682M (53021) -OR-	EA	1				*	*	*	*	*	3-17	1A4A5C35		
P-H	5910-681-2362	CAPACITOR, FIXED, PAPER DIELECTRIC SDBLKD3472J (53021) -OR-	EA	1				*	*	*	*	*	3-17	1A4A5C35		
P-H	5910-893-9766	CAPACITOR, FIXED, PAPER DIELECTRIC SDBLKD2562M (53021)	EA	1				*	*	*	*	*	3-17	1A4A5C35		
P-H	5820-790-1820	LEVER, TUNER 544-6031-002 (13499)	EA	1				*	*	*	*	*				
P-O		KIT, MOUNTING 541-1477-002 (13499)	EA	9	*	*	*	*	*	*	*	*				
M-H		BAG, COTTON 024-0100-000 (13499)	EA	12												
P-O	5310-054-1830	WASHER, LOCK MS3538-80 (96906)	EA	REF	*	*	*	*	*	*	*	*				
P-O		WASHER, FLAT 310-0167-000 (79807)	EA	72	*	*	*	*	*	*	*	*				
P-O		WASHER, LOCK 310-0286-000 (13499)	EA	76	*	*	*	*	*	*	*	*				
P-O	5305-579-3507	SCREW, MACHINE MS35216-40 (96906)	EA	30	*	*	*	*	*	*	*	*				
P-O		SCREW, MACHINE P343-0247-000 (77250)	EA	72	*	*	*	*	*	*	*	*				
X2-F		CLAMP, SHAFT 543-3078-002 (13499)	EA	REF												
P-F	5821-396-3116	CLAMP 504-7537-002 (13499)	EA	REF	*	*	*	*	*	*	*	*				
P-H		SPRING, HELICAL 500-2179-002 (13499)	EA	2				*	*	*	*	*				
P-F		SCREW, CAPTIVE SOCKET HEAD 4-40X1-26SPLINECADPL (08664)	EA	REF	*	*	*	*	*	*	*	*				
P-F		SCREW, CAPTIVE 324-1682-100 (13499)	EA	REF	*	*	*	*	*	*	*	*				
P-F		NUT, PLAIN, SQUARE P334-0486-000 (77250)	EA	REF	*	*	*	*	*	*	*	*				
M-H		BAG, COTTON 024-0100-000 (13499)	EA	REF												

SECTION III REPAIR PARTS FOR DIRECT SUPPORT, GENERAL SUPPORT, AND DEPOT MAINTENANCE (CONTINUED)

(1) S/R CODE	(2) FEDERAL STOCK NUMBER	(3) DESCRIPTION  REFERENCE NUMBER & MFR. CODE	(4) USABLE ON CODE	(5) UNIT OF MEAS	(6) 30-DAY DS MAINT ALLOWANCE	(7) 30-DAY GS MAINT ALLOWANCE			(8) 1 YR ALW PER EQUIP CMTY	(9) DEPOT MAINT ALW PER 100 EQUIP	(10) ILLUSTRATIONS				
						(a) 1-20	(b) 21-50	(c) 51-100			(a) 1-20	(b) 21-50	(c) 51-100	(a) FIG NO.	(b) ITEM NO. OR REFERENCE DESIGNATION
A-O-R		GROUP 02 - SIDEBAND GENERATOR 786F-1													
		SIDEBAND GENERATOR 786F-1 522-0861-034 (13499)		EA	1						3-1	1A5			
M-D		PLATE, IDENTIFICATION 280-0450-000 (74048)		EA	REF										
M-D		PLATE, IDENTIFICATION 280-1254-000 (12998)		EA	REF										
P-F	5310-011-1041	WASHER, LOCK MS35338-79 (96906)		EA	REF	*	*	*	*	*					
P-F		WASHER, FLAT 310-6360-000 (79807)		EA	REF	*	*	*	*	*					
P-O		SCREW, TAPPING THREAD FORMING 2XL-8PANHDYTPBCADPL (45722)		EA	REF	*	*	*	*	*					
P-F	5310-857-55471	NUT, SELF-LOCKING HEXAGON MS21044006 (96906)		EA	REF	*	*	*	*	*					
A-F		AMPLIFIER-TRANSMIT GAIN CONTROL 543-5181-003 (13499)		EA	1						3-18	1A5A1			
P-H	5310-614-3500	NUT, SELF-LOCKING, HEXAGON 68-1660-40 (72962)		EA	REF										
P-F	5305-777-6039	SCREW, MACHINE SE25SCADPL (90030)		EA	REF	*	*	*	*	*					
P-F	5305-764-2966	SCREW, MACHINE 543-2510-004 (13499)		EA	REF	*	*	*	*	*					
X2-F		PLATE, COVER 756-4280-002 (13499)		EA	1										
X2-F		PLATE, COVER 542-7696-003 (13499)		EA	REF										
P-F	5305-054-5647	SCREW, MACHINE MS51957-13 (96906)		EA	REF	*	*	*	*	*					
P-F		INSERT-TUBE 542-0371-002 (13499)		EA	1	*	*	*	*	*	3-19	1A5A1E1			
P-F		SHIELD-TUBE 542-0375-002 (13499)		EA	1	*	*	*	*	*	3-19	1A5A1E2			
X1-F		SHIELD-EXTRUDED 542-0378-012 (13499)		EA	REF										
X2-F		BASE-RIVETED 544-2869-002 (13499)		EA	1										
P-H		PIN-LOCATING 541-6556-002 (13499)		EA	REF										
X2-F		PLATE-BASE 544-2874-003 (13499)		EA	1										
X2-F		PLATE-CASTING 543-1494-014 (13499)		EA	REF										
X2-F		CHASSIS BOARD MOUNTING 544-2872-002 (13499)		EA	1										
P-F		NUT-SPECIAL 543-1036-002 (13499)		EA	5	*	*	*	*	*					
X2-F		CHASSIS MOUNTING BOARD 544-2875-003 (13499)		EA	1										
X2-F		FRAME, CHASSIS 544-2871-002 (13499)		EA	1										
X2-F	5320-117-6010	RIVET, SOLID MS20426AD2-3 (96906)		EA	REF										

SECTION III REPAIR PARTS FOR DIRECT SUPPORT, GENERAL SUPPORT, AND DEPOT MAINTENANCE (CONTINUED)

(1) SQR CODE	(2) FEDERAL STOCK NUMBER	(3) DESCRIPTION  REFERENCE NUMBER & MFR. CODE	(4) UNIT OF MEAS	(5) QTY INC IN UNIT	(6) 30-DAY DS MAINT ALLOWANCE			(7) 30-DAY GS MAINT ALLOWANCE			(8) 1 YR ALW PER EQUIP CNTGCTY	(9) DEPOT MAINT ALW PER 100 EQUIP	(10) ILLUSTRATIONS	
					(a) 1-20	(b) 21-50	(c) 51-100	(a) 1-20	(b) 21-50	(c) 51-100			(a) FIG NO.	(b) ITEM NO. OR REFERENCE DESIGNATION
X2-P		FRAME-CHASSIS 544-2876-004 (13499)	EA	1										
P-H		BRACKET, RETAINING SCREW 542-7768-002 (13499)	EA	REF				*	*	*	*	*		
P-H	5820-678-5324	BOARD ASSEMBLY 543-1030-003 (13499)	EA	1				*	*	*	*	*		
P-H	5950-583-0981	TRANSFORMER, INTERMEDIATE FREQUENCY XD69-1 (81815)	EA	1				*	*	*	*	*	3-19	1A5A1T1
P-H	5950-583-0917	TRANSFORMER, INTERMEDIATE FREQUENCY XD70-1 (81815)	EA	1				*	*	*	*	*	3-19	1A5A1T2
M-H		INSULATION SLEEVING, ELECTRICAL TEFTW24-3 (81851)	FT	REF										
M-H		INSULATION SLEEVING, ELECTRICAL TEFTW24-1 (81851)	FT	1										
M-H		INSULATION SLEEVING, ELECTRICAL TEFTW24-6 (81851)	FT	REF										
M-H		INSULATION SLEEVING, ELECTRICAL TEFTW24-5 (81851)	FT	REF										
M-H		INSULATION SLEEVING, ELECTRICAL TEFTW24-4 (81851)	FT	REF										
M-H		INSULATION SLEEVING, ELECTRICAL TEFTW22-0 (81851)	FT	REF										
P-H	5910-057-4140	CAPACITOR, FIXED, ELECTROLYTIC CL24BJAR51P3 (81349)	EA	1				*	*	*	*	*	3-19	1A5A1C6
P-H	5910-836-1289	CAPACITOR, FIXED, ELECTROLYTIC CL34BQR5MF3 (81349)	EA	1				*	*	*	*	*	3-19	1A5A1C4
P-H	5950-683-3437	COIL, RADIO FREQUENCY 18-180 (09250)	EA	2				*	*	*	*	*	3-19	1A5A1L1
P-H	5950-683-3437	COIL, RADIO FREQUENCY 18-180 (09250)	EA	REF				*	*	*	*	*	3-19	1A5A1L2
P-H	5960-256-9989	ELECTRON TUBE 5899 (82219)	EA	1				*	*	*	*	*	3-19	1A5A1V1
M-H		WIRE, ELECTRICAL 00702-1322 (70567)	EA	REF										
P-H	5905-279-1756	RESISTOR, FIXED, COMPOSITION RC20GF151K (81349)	EA	1				*	*	*	*	*	3-19	1A5A1R4
P-H	5910-663-5850	CAPACITOR, FIXED, MICA DIELECTRIC 22H5T27EG (14655)	EA	1				*	*	*	*	*	3-19	1A5A1C10
P-H	5905-192-0667	RESISTOR, FIXED, COMPOSITION RC20GF224K (81349)	EA	2				*	*	*	*	*	3-19	1A5A1R1
P-H	5905-192-0667	RESISTOR, FIXED, COMPOSITION RC20GF224K (81349)	EA	REF				*	*	*	*	*	3-19	1A5A1R2
P-F	5905-192-0390	RESISTOR, FIXED, COMPOSITION RC20GF105K (81349)	EA	1	*	*	*	*	*	*	*	*	3-19	1A5A1R3
P-H	5905-299-2039	RESISTOR, FIXED, COMPOSITION RC32CF92K (81349)	EA	1				*	*	*	*	*	3-19	1A5A1R5
P-H	5910-984-4144	CAPACITOR, FIXED, MICA DIELECTRIC 22H5T24EG (14655)	EA	1				*	*	*	*	*	3-19	1A5A1C1
P-F	5910-060-9619	CAPACITOR, FIXED, MICA DIELECTRIC 22H5T51EG (14655)	EA	1	*	*	*	*	*	*	*	*	3-19	1A5A1C2
P-H	5910-835-2175	CAPACITOR, FIXED, PAPER DIELECTRIC SD81K01103M (53021)	EA	2				*	*	*	*	*	3-19	1A5A1C3
P-H	5910-835-2175	CAPACITOR, FIXED, PAPER DIELECTRIC SD81K01103M (53021)	EA	REF				*	*	*	*	*	3-19	1A5A1C5

SECTION III REPAIR PARTS FOR DIRECT SUPPORT, GENERAL SUPPORT, AND DEPOT MAINTENANCE (CONTINUED)

(1) SQR CODE	(2) FEDERAL STOCK NUMBER	(3) DESCRIPTION  REFERENCE NUMBER & MFR. CODE	(4) UNIT OF MEAS	(5) QTY INC IN UNIT	(6) 30-DAY DS MAINT ALLOWANCE			(7) 30-DAY GS MAINT ALLOWANCE			(8) 1 YR ALW PER EQUIP CNTBCTY	(9) DEPOT MAINT PER 100 EQUIP	(10) ILLUSTRATIONS	
					(a) 1-20	(b) 21-50	(c) 51-100	(a) 1-20	(b) 21-50	(c) 51-100			(a) FIG NO.	(d) ITEM NO. OR REFERENCE DESIGNATION
P-H	5910-553-5036	CAPACITOR, FIXED, PAPER DIELECTRIC SDB1K0110QM (53021)	EA	1				*	*	*	*	*	3-19	1A5A1C7
P-H	5910-617-3246	CAPACITOR, FIXED, PAPER DIELECTRIC SDB1K02333M (53021)	EA	1				*	*	*	*	*	3-19	1A5A1O9
P-H	5910-543-9197	CAPACITOR, FIXED, PAPER DIELECTRIC SDB1K0210QM (53021)	EA	1				*	*	*	*	*	3-19	1A5A1C8
P-H	5999-790-0594	PRINTED CIRCUIT BOARD 543-1031-003 (13499)	EA	1				*	*	*	*	*	3-19	1A5A1T81
P-H		TERMINAL, STUD 542-4085-002 (13499)	EA	REF				*	*	*	*	*		
X2-H		EYELET, METALLIC SE26CADFL (90030)	EA	2										
X2-H		EYELET, METALLIC 542-0811-003 (13499)	EA	REF										
X2-H		BRACKET, SUPPORT 543-1046-002 (13499)	EA	1										
X2-H		BRACKET, SUPPORT 543-1047-002 (13499)	EA	1										
X1-H		PRINTED CIRCUIT BOARD 543-1032-003 (13499)	EA	1										
P-H	5935-615-3914	JACK, TIP SKT2BC (98291)	EA	2				*	*	*	*	*	3-19	1A5A1J1
P-H	5935-615-3914	JACK, TIP SKT2BC (98291)	EA	REF				*	*	*	*	*	3-19	1A5A1J2
P-H		SCREW, CAPTIVE 542-7683-002 (13499)	EA	REF				*	*	*	*	*		
X2-F		PLATE-COVER 542-7696-003 (13499)	EA	REF										
P-F	5305-054-6654	SCREW, MACHINE MS51957-30 (96906)	EA	REF	*	*	*	*	*	*	*	*		
P-F	5305-054-6650	SCREW, MACHINE MS51957-26 (96906)	EA	REF	*	*	*	*	*	*	*	*		
P-F	5305-054-6651	SCREW, MACHINE MS51957-27 (96906)	EA	REF	*	*	*	*	*	*	*	*		
P-F	5310-209-1366	WASHER, LOCK MS35335-58 (96906)	EA	REF	*	*	*	*	*	*	*	*		
A-F		FRAME ASSEMBLY 540-6336-004 (13499)	EA	1										
P-F		SETScrew 10-32X5-86SPLINZ416SST (08664)	EA	REF	*	*	*	*	*	*	*	*		
P-F	5305-765-4346	SCREW, MACHINE MS51959-35 (96906)	EA	24	*	*	*	*	*	*	*	*		
P-F	5305-765-4257	SCREW, MACHINE MS51959-43 (96906)	EA	REF	*	*	*	*	*	*	*	*		
P-F	5305-054-6650	SCREW, MACHINE MS51957-26 (96906)	EA	REF	*	*	*	*	*	*	*	*		
P-F	5305-579-3513	SCREW, MACHINE MS35217-55 (96906)	EA	22	*	*	*	*	*	*	*	*		
P-F	5310-209-1366	WASHER, LOCK MS35335-58 (96906)	EA	REF	*	*	*	*	*	*	*	*		
P-F	5310-054-1831	WASHER, LOCK MS35338-81 (96906)	EA	15	*	*	*	*	*	*	*	*		
P-F		POST, STANDOFF 561-2189-002 (13499)	EA	REF	*	*	*	*	*	*	*	*		
P-F	5315-791-7836	SCREW, EXTERNALLY RELIEVED BODY 540-6241-002 (13499)	EA	REF	*	*	*	*	*	*	*	*		

SECTION III REPAIR PARTS FOR DIRECT SUPPORT, GENERAL SUPPORT, AND DEPOT MAINTENANCE (CONTINUED)

(1) SNR CODE	(2) FEDERAL STOCK NUMBER	(3) DESCRIPTION  REFERENCE NUMBER & MFR. CODE	(4) UNIT OF MEAS  USABLE OR CODE	(5) QTY INC IN UNIT	(6) 30-DAY DS MAINT ALLOWANCE			(7) 30-DAY GS MAINT ALLOWANCE			(8) 1 YR ALW PER EQUIP CWTGCT	(9) DEPOT MAINT ALW PER 100 EQUIP	(10) ILLUSTRATIONS	
					(a) 1-20	(b) 21-50	(c) 51-100	(a) 1-20	(b) 21-50	(c) 51-100			(a) FIG NO.	(b) ITEM NO. OR REFERENCE DESIGNATION
					X1-F		BLOCK SPACER 540-6243-002 (13499)	EA	2					
X2-F		PLATE, HINGE 540-6240-002 (13499)	EA	REF										
X2-F		PLATE, PIVOT 540-6242-002 (13499)	EA	2										
P-F	5340-634-7444	RING, RETAINING MS16632-101B (96906)	EA	REF	*	*	*	*	*	*	*			
X1-F		BUMPER, CHASSIS 561-2375-003 (13499)	EA	4										
X2-F		PLATE, HINGE 540-6260-002 (13499)	EA	3										
X1-F		PIN, GROOVED 541-3627-002 (13499)	EA	REF										
X2-F		PLATE, HINGE 540-6236-002 (13499)	EA	3										
X2-F		BLOCK, CENTER 540-6375-003 (13499)	EA	2										
P-H		NUT, PLAIN, ROUND 540-6244-002 (13499)	EA	144				*	*	*	*	*		
X2-H		BLOCK, CENTER 540-6254-003 (13499)	EA	2										
X2-H		FRAME-STAKED 540-6330-004 (13499)	EA	2										
P-H		NUT, PLAIN, ROUND 540-6244-002 (13499)	EA	REF				*	*	*	*	*		
X2-H		FRAME-SPOTWELDED 540-6318-004 (13499)	EA	2										
X1-H		CHANNEL, CHASSIS 540-6300-004 (13499)	EA	6										
X1-H		CHANNEL, CHASSIS 540-6301-004 (13499)	EA	6										
X1-H		BRACKET, END 540-6247-003 (13499)	EA	2										
X2-H		PLATE, SPACER 540-6265-003 (13499)	EA	4										
X1-H		PLATE, SLIDING 542-3236-002 (13499)	EA	6										
A-F		GENERATOR SUBASSEMBLY 542-7788-005 (13499)	EA	1								3-18	1A5A7	
P-F	5945-679-9456	RELAY, ARMATURE 83-3243 (04221)	EA	1	*	*	*	*	*	*	*	3-20	1A5A7K1	
P-F	6625-679-9458	ARMATURE 11208BL (81030)	EA	1	*	*	*	*	*	*	*	3-21	1A5A7M1	
P-F	5930-901-1782	SWITCH, ROTARY 182645K1 (76854)	EA	1	*	*	*	*	*	*	*	3-21	1A5A7S1	
P-F	5930-679-9460	SWITCH, ROTARY 199670K1 (76854)	EA	1	*	*	*	*	*	*	*	3-21	1A5A7S2	
P-F	5950-679-9461	TRANSFORMER, AUDIO FREQUENCY A10760 (70674)	EA	4	*	*	*	*	*	*	*	3-20	1A5A7T1	
P-F	5950-679-9461	TRANSFORMER, AUDIO FREQUENCY A10760 (70674)	EA	REF	*	*	*	*	*	*	*	3-20	1A5A7T2	
P-F	5950-679-9461	TRANSFORMER, AUDIO FREQUENCY A10760 (70674)	EA	REF	*	*	*	*	*	*	*	3-20	1A5A7T3	
P-F	5950-679-9461	TRANSFORMER, AUDIO FREQUENCY A10760 (70674)	EA	REF	*	*	*	*	*	*	*	3-20	1A5A7T4	
P-F	5325-276-4221	GROMMET, RUBBER 911 (75543)	EA	REF	*	*	*	*	*	*	*			
P-F	5355-079-9556	KNOB-MODIFIED 547-1380-002 (13499)	EA	1	*	*	*	*	*	*	*		1A5A7O1	
X1-F		KNOB 14000BLK (72512)	EA	1										
W-H		CLAMP, LOOP HPSN (0992)	EA	REF										

SECTION III REPAIR PARTS FOR DIRECT SUPPORT, GENERAL SUPPORT, AND DEPOT MAINTENANCE (CONTINUED)

(1) SMR CODE	(2) FEDERAL STOCK NUMBER	(3) DESCRIPTION  REFERENCE NUMBER & MFR. CODE  USABLE ON CODE	(4) UNIT OF MEAS	(5) QTY INC IN UNIT	(6) 30-DAY DS MAINT ALLOWANCE			(7) 30-DAY GS MAINT ALLOWANCE			(8) 1 YR ALW PER EQUIP CNTGTY	(9) DEPOT MAINT ALW PER 100 EQUIP	(10) ILLUSTRATIONS	
					(a)	(b)	(c)	(a)	(b)	(c)			(a)	(b)
					1-20	21-50	51-100	1-20	21-50	51-100			FIG NO.	ITEM NO. OR REFERENCE DESIGNATION
P-F	5935-729-7312	SOCKET, ELECTRON 7490-0189 (80368)	EA	1	*	*	*	*	*	*	*	3-20	1A5A7XV1	
P-O	5960-262-0210	ELECTRON TUBE 5814A (89185)	EA	1	*	*	*	*	*	*	*	3-21	1A5A7V1	
P-F	5340-598-0496	CLAMP, LOOP HPEN (09922)	EA	2	*	*	*	*	*	*	*			
P-F		TERMINAL, LUG 2104-06-02-2520N (78189)	EA	REF	*	*	*	*	*	*	*			
X1-F		BEZEL, INSTRUMENT MOUNTING A1-481-1 (81030)	EA	2										
X2-F		MOUNTING PLATE A1-480-2 (81030)	EA	2										
P-F		SPLIT LOCK WASHER 1452-008 (81030)	EA	4	*	*	*	*	*	*	*			
P-F		NUT, HEXAGON 1002-008 (81030)	EA	4	*	*	*	*	*	*	*			
P-F		ROUND, HEAD SCREW 1501-412 (81030)	EA	8	*	*	*	*	*	*	*			
P-F		NUT, PLAIN, HEXAGON P313-0156-000 (77250)	EA	REF	*	*	*	*	*	*	*			
P-F	5310-271-4640	NUT, PLAIN, HEXAGON MS35649-24 (96906)	EA	REF	*	*	*	*	*	*	*			
P-F		NUT, PLAIN, HEXAGON P334-4120-000 (77250)	EA	30	*	*	*	*	*	*	*			
P-H	5305-054-5653	SCREW, MACHINE MS51957-19 (96906)	EA	REF				*	*	*	*			
P-F		WASHER, FLAT 310-0044-000 (79807)	EA	REF	*	*	*	*	*	*	*			
P-F	5305-777-6039	SCREW, MACHINE MS51959-12 (96906)	EA	REF	*	*	*	*	*	*	*			
P-F	5305-763-7822	SCREW, MACHINE MS51959-14 (96906)	EA	REF	*	*	*	*	*	*	*			
P-H	5305-616-2568	SCREW, MACHINE P343-0285-000 (77250)	EA	REF				*	*	*	*			
P-F		SCREW, MACHINE P343-0286-000 (77250)	EA	REF	*	*	*	*	*	*	*			
P-F		SCREW, MACHINE P342-0024-000 (77250)	EA	20	*	*	*	*	*	*	*			
P-F	5340-205-4731	RING, RETAINING MS16633-1009 (96906)	EA	REF	*	*	*	*	*	*	*			
P-F	5305-054-6650	SCREW, MACHINE MS51957-26 (96906)	EA	REF	*	*	*	*	*	*	*			
P-F	5310-183-4354	WASHER, FLAT 506-7367-002 (13499)	EA	REF	*	*	*	*	*	*	*			
P-F		TERMINAL, STUD 2A1DB12 (92825)	EA	7	*	*	*	*	*	*	*		1A5A7E4	
P-F		TERMINAL, STUD 2A1DB12 (92825)	EA	REF	*	*	*	*	*	*	*		1A5A7E5	
P-F		TERMINAL, STUD 2A1DB12 (92825)	EA	REF	*	*	*	*	*	*	*		1A5A7E6	
P-F		TERMINAL, STUD 2A1DB12 (92825)	EA	REF	*	*	*	*	*	*	*		1A5A7E7	
P-F		TERMINAL, STUD 2A1DB12 (92825)	EA	REF	*	*	*	*	*	*	*		1A5A7E8	
P-F		TERMINAL, STUD 2A1DB12 (92825)	EA	REF	*	*	*	*	*	*	*		1A5A7E9	
P-F		TERMINAL, STUD 2A1DB12 (92825)	EA	REF	*	*	*	*	*	*	*		1A5A7E10	
P-F		NUT, PLAIN, HEXAGON P313-0132-000 (77250)	EA	REF	*	*	*	*	*	*	*			
P-F	5310-907-0958	WASHER, FLAT 310-0045-000 (79807)	EA	REF	*	*	*	*	*	*	*			

SECTION III REPAIR PARTS FOR DIRECT SUPPORT, GENERAL SUPPORT, AND DEPOT MAINTENANCE (CONTINUED)

(1) SIR CODE	(2) FEDERAL STOCK NUMBER	(3) DESCRIPTION  REFERENCE NUMBER & MFR. CODE	(4) UNIT OF MEAS	(5) QTY INC IN UNIT	(6) 30-DAY DS MAINT ALLOWANCE			(7) 30-DAY GS MAINT ALLOWANCE			(8) 1 YR ALW PER EQUIP CNTGCT	(9) DEPOT MAINT ALW PER 100 EQUIP	(10) ILLUSTRATIONS	
					(a) 1-20	(b) 21-50	(c) 51-100	(a) 1-20	(b) 21-50	(c) 51-100			(a) FIG NO.	(b) ITEM NO. OR REFERENCE DESIGNATION
P-H	5310-559-7792	WASHER, LOCK AN93684B (88044)	EA	REF				*	*	*	*	*		
P-F	5310-058-3599	WASHER, LOCK MS35335-37 (96906)	EA	REF	*	*	*	*	*	*	*	*		
P-H		WASHER, LOCK 310-0076-000 (79807)	EA	REF				*	*	*	*	*		
P-F	5310-209-1366	WASHER, LOCK MS35335-58 (96906)	EA	REF	*	*	*	*	*	*	*	*		
P-F		WASHER, LOCK 1720-02CANPL (78189)	EA	42	*	*	*	*	*	*	*	*		
P-F	5905-542-7639	RESISTOR, VARIABLE JA21072 (71450)	EA	2	*	*	*	*	*	*	*	*	3-20	1A5A7R1
P-F	5905-542-7639	RESISTOR, VARIABLE JA21072 (71450)	EA	REF	*	*	*	*	*	*	*	*	3-20	1A5A7R2
P-F	5905-678-5320	RESISTOR, VARIABLE JA21071 (71450)	EA	1	*	*	*	*	*	*	*	*	3-20	1A5A7R3
P-F	5905-023-9089	RESISTOR, VARIABLE JA21070 (71450)	EA	1	*	*	*	*	*	*	*	*	3-20	1A5A7R4
P-F	5905-678-5096	RESISTOR, VARIABLE JA21067 (71450)	EA	1	*	*	*	*	*	*	*	*	3-21	1A5A7R15
P-F		SCREW, MACHINE P342-0153-000 (77250)	EA	12	*	*	*	*	*	*	*	*		
P-F	5305-054-6652	SCREW, MACHINE MS51957-28 (96906)	EA	REF	*	*	*	*	*	*	*	*		
P-F		POST, SPACING 540-9184-003 (13499)	EA	2	*	*	*	*	*	*	*	*		
P-F	5310-167-0847	WASHER, LOCK AN93686B (88044)	EA	REF	*	*	*	*	*	*	*	*		
P-F		NUT, PLAIN, HEXAGON P313-9051-000 (77250)	EA	REF	*	*	*	*	*	*	*	*		
P-F		SCREW, MACHINE P342-0152-000 (77250)	EA	13	*	*	*	*	*	*	*	*		
P-H		TERMINAL, LUG 2104-04-01-2520M (78189)	EA	REF				*	*	*	*	*		
P-F	5905-774-5166	RESISTOR, VARIABLE JA21068 (71450)	EA	1	*	*	*	*	*	*	*	*	3-21	1A5A7R16
P-H		CORD, NYLON 435-1014-000 (13499)	FT	REF				*	*	*	*	*		
P-F	5960-860-7710	SHIELD ASSEMBLY 541-6594-003 (13499)	EA	1	*	*	*	*	*	*	*	*		1A5A7E1
P-H	5960-519-6952	SHIELD, ELECTRON 191-0P1001 (91662)	EA	REF				*	*	*	*	*		
P-H	5960-552-0236	SHIELD ASSEMBLY 541-8166-002 (13499)	EA	REF				*	*	*	*	*		
P-H	5960-686-8087	SHIELD, ELECTRON 541-8161-002 (13499)	EA	REF				*	*	*	*	*		
XL-H		SHIELD 541-8161-012 (13499)	EA	REF				*	*	*	*	*		
P-F	5340-769-2243	SPRING, HELICAL 541-8164-002 (13499)	EA	REF	*	*	*	*	*	*	*	*		
P-H	5960-649-8665	RETAINER 541-6521-002 (13499)	EA	REF				*	*	*	*	*		
XL-H		PLATE, MOUNTING 544-7255-003 (13499)	EA	1				*	*	*	*	*		

SECTION III REPAIR PARTS FOR DIRECT SUPPORT, GENERAL SUPPORT, AND DEPOT MAINTENANCE (CONTINUED)

(1) SNR CODE	(2) FEDERAL STOCK NUMBER	(3) DESCRIPTION  REFERENCE NUMBER & WPA. CODE	(4) UNIT OF MEAS  USABLE ON CODE	(5) QTY INC IN UNIT	(6) 30-DAY DS MAINT ALLOWANCE			(7) 30-DAY GS MAINT ALLOWANCE			(8) 1 YR ALW PER EQUIP CONTACT	(9) DEPOT MAINT ALW PER 100 EQUIP	(10) ILLUSTRATIONS		
					(a)	(b)	(c)	(a)	(b)	(c)			(a)	(b)	(6) ITEM NO. OR REFERENCE DESIGNATION
					1-20	21-40	51-100	1-20	21-50	51-100			1-20	21-50	51-100
P-F		NUT, SELF-LOCKING, CLINCH 541-8164-002 (13499)	EA	REF	*	*	*	*	*	*	*	*			
XI-H		POST, MOUNTING 543-1374-002 (13499)	EA	18											
X2-H		PLATE, FRONT 544-7254-005 (13499)	EA	1											
P-H	5340-687-3115	CLIP, SPRING, TENSION 100-200-10-0 (99378)	EA	1				*	*	*	*	*			
XI-H		RIVET, TUBULAR R3307X1-8CADPL (12014)	EA	3											
A-F		AMPLIFIER SUBASSEMBLY 543-2841-002 (13499)	EA	1											
P-H	5961-866-0476	SEMICONDUCTOR DEVICE, DIODE 1N457 (07688)	EA	5				*	*	*	*	*	3-20	1A5A7CR1	
P-H	5961-866-0476	SEMICONDUCTOR DEVICE, DIODE 1N457 (07688)	EA	REF				*	*	*	*	*	3-20	1A5A7CR4	
P-H	5961-866-0476	SEMICONDUCTOR DEVICE, DIODE 1N457 (07688)	EA	REF				*	*	*	*	*	3-20	1A5A7CR5	
P-H	5961-866-0476	SEMICONDUCTOR DEVICE, DIODE 1N457 (07688)	EA	REF				*	*	*	*	*	3-20	1A5A7CR6	
P-H	5961-866-0476	SEMICONDUCTOR DEVICE, DIODE 1N457 (07688)	EA	REF				*	*	*	*	*	3-20	1A5A7CR7	
P-F	5905-993-5961	RESISTOR, FIXED, FILM RN70L2613F (81349)	EA	1	*	*	*	*	*	*	*	*	3-20	1A5A7R12	
P-F	5905-950-5594	RESISTOR, FIXED, FILM RN70D5113F (81349)	EA	1	*	*	*	*	*	*	*	*	3-20	1A5A7R18	
P-H	5905-192-3987	RESISTOR, FIXED, COMPOSITION RC20GF104K (81349)	EA	1	*	*	*	*	*	*	*	*		1A5A7R13	
P-H	5905-192-0667	RESISTOR, FIXED, COMPOSITION RC20GF224K (81349)	EA	1	*	*	*	*	*	*	*	*	3-20	1A5A7R5	
P-F	5905-247-8687	RESISTOR, FIXED, COMPOSITION RC20GF825K (81349)	EA	1	*	*	*	*	*	*	*	*		1A5A7R19	
P-F	5820-813-0739	TERMINAL BOARD 543-2839-002 (13499)	EA	1	*	*	*	*	*	*	*	*		1A5A7TB1	
XI-F		TERMINAL, STUD X1463C (71279)	EA	74											
XI-F		TERMINAL BOARD 543-2838-002 (13499)	EA	1											
P-F	5961-840-5466	SEMICONDUCTOR DEVICE, DIODE 1N458 (07688)	EA	2	*	*	*	*	*	*	*	*	3-20	1A5A7CR2	
P-F	5961-840-5466	SEMICONDUCTOR DEVICE, DIODE 1N458 (07688)	EA	REF	*	*	*	*	*	*	*	*	3-20	1A5A7CR3	
XI-F		PANEL, POWER DISTRIBUTION 544-7253-003 (13499)	EA	1											
XI-F		SHIELD 543-2837-002 (13499)	EA	1											
P-F		NUT, PLAIN, HEXAGON P313-0045-000 (77250)	EA	REF	*	*	*	*	*	*	*	*			
P-F	5310-275-1347	WASHER, FLAT 310-0046-000 (79807)	EA	REF	*	*	*	*	*	*	*	*			
P-F	5905-299-2058	RESISTOR, FIXED, COMPOSITION RC32GF151K (81349)	EA	2	*	*	*	*	*	*	*	*	3-20	1A5A7R20	
P-F	5905-299-2058	RESISTOR, FIXED, COMPOSITION RC32GF151K (81349)	EA	REF	*	*	*	*	*	*	*	*		1A5A7R21	



SECTION III REPAIR PARTS FOR DIRECT SUPPORT, GENERAL SUPPORT, AND DEPOT MAINTENANCE (CONTINUED)

(1) SMP CODE	(2) FEDERAL STOCK NUMBER	(3) DESCRIPTION  REFERENCE NUMBER & MFR. CODE	(4) UNIT OF MEAS	(5) QTY INC IN UNIT	(6) 30-DAY DS MAINT ALLOWANCE			(7) 30-DAY GS MAINT ALLOWANCE			(8) 1 YR ALW PER EQUIP CATGCT	(9) DEPOT MAINT ALW PER 100 EQUIP	(10) ILLUSTRATIONS	
					(a) 1-20	(b) 21-50	(c) 51-100	(a) 1-20	(b) 21-50	(c) 51-100			(a) FIG NO.	(b) ITEM NO. OR REFERENCE DESIGNATION
P-H	5905-185-6946	RESISTOR, FIXED, COMPOSITION RC20GF474K (81349)	EA	2				*	*	*	*	*	3-20	1A5A7R6
P-H	5905-185-6946	RESISTOR, FIXED, COMPOSITION RC20GF474K (81349)	EA	REF				*	*	*	*	*	3-20	1A5A7R10
P-F	5905-192-0390	RESISTOR, FIXED, COMPOSITION RC20GF109K (81349)	EA	1	*	*	*	*	*	*	*	*	3-20	1A5A7R7
P-H	5905-257-2631	RESISTOR, FIXED, COMPOSITION RC20GF821K (81349)	EA	2				*	*	*	*	*	3-20	1A5A7R8
P-H	5905-257-2631	RESISTOR, FIXED, COMPOSITION RC20GF821K (81349)	EA	REF				*	*	*	*	*	3-20	1A5A7R9
P-F	5905-063-8405	RESISTOR, FIXED, FILM RM65D2151F (81349)	EA	1	*	*	*	*	*	*	*	*	3-20	1A5A7R11
P-F	5305-763-6963	SCREW, MACHINE MS51959-28 (96906)	EA	REF	*	*	*	*	*	*	*	*		
P-F	5910-686-7725	CAPACITOR, FIXED, PAPER DIELECTRIC SDA30L473M (53021)	EA	2	*	*	*	*	*	*	*	*	3-20	1A5A7C37
P-F	5910-686-7725	CAPACITOR, FIXED, PAPER DIELECTRIC SDA30L473M (53021)	EA	REF	*	*	*	*	*	*	*	*	3-20	1A5A7C38
P-H		POST, SPACING 541-0163-002 (13499)	EA	16				*	*	*	*	*		
M-H		WIRING HARNESS 543-2835-000 (13499)	EA	1										
P-H		CABLE, SPECIAL PURPOSE, ELECTRICAL 25SUB730MJA109-6 (90484)	FT	5				*	*	*	*	*		
P-H		CABLE, SPECIAL PURPOSE, ELECTRICAL 25SUB730MJA109-3 (90484)	FT	3				*	*	*	*	*		
P-H		CABLE, SPECIAL PURPOSE, ELECTRICAL 25SUB730MJA109-5 (90484)	FT	3				*	*	*	*	*		
P-H		CABLE, SPECIAL PURPOSE, ELECTRICAL 25SUB730MJA109-1 (90484)	FT	5				*	*	*	*	*		
M-H		WIRE, ELECTRICAL MILW16878TYPB22-9 (81349)	FT	REF										
M-H		WIRE, ELECTRICAL MILW16878TYPB22-90 (81349)	FT	REF										
M-H		WIRE, ELECTRICAL MILW16878TYPB22-91 (81349)	FT	REF										
M-H		WIRE, ELECTRICAL MILW16878TYPB22-92 (81349)	FT	REF										
M-H		WIRE, ELECTRICAL MILW16878TYPB22-93 (81349)	FT	REF										
M-H		WIRE, ELECTRICAL MILW16878TYPB22-95 (81349)	FT	REF										
M-H		WIRE, ELECTRICAL MILW16878TYPB22-96 (81349)	FT	REF										
M-H		WIRE, ELECTRICAL MILW16878TYPB22-902 (81349)	FT	REF										
M-H		WIRE, ELECTRICAL MILW16878TYPB22-903 (81349)	FT	REF										
M-H		WIRE, ELECTRICAL MILW16878TYPB22-905 (81349)	FT	REF										
M-H		WIRE, ELECTRICAL MILW16878TYPB22-906 (81349)	FT	REF										
M-H		WIRE, ELECTRICAL MILW16878TYPB22-912 (81349)	FT	REF										

TM 11-5820-555-24P  
SECTION III REPAIR PARTS FOR DIRECT SUPPORT, GENERAL SUPPORT, AND DEPOT MAINTENANCE (CONTINUED)

(1) SNR CODE	(2) FEDERAL STOCK NUMBER	(3) DESCRIPTION  REFERENCE NUMBER & MFR. CODE	(4) UNIT OF MEAS	(5) QTY INC IN UNIT	(6) 30-DAY DS MAINT ALLOWANCE			(7) 30-DAY GS MAINT ALLOWANCE			(8) 1 YR ALW PER EQUIP CATGRY	(9) DEPOT MAINT ALW PER 100 EQUIP	(10) ILLUSTRATIONS	
					(a)	(b)	(c)	(a)	(b)	(c)			(a) FIG NO.	(b) ITEM NO. OR REFERENCE DESIGNATION
					1-20	21-50	51-100	1-20	21-50	51-100				
M-H		WIRE, ELECTRICAL MILW16878TYFEB22-913 (81349)	FT	REF										
M-H		WIRE, ELECTRICAL MILW16878TYFEB22-915 (81349)	FT	REF										
M-H		WIRE, ELECTRICAL MILW16878TYFEB22-916 (81349)	FT	REF										
M-H		WIRE, ELECTRICAL MILW16878TYFEB22-923 (81349)	FT	REF										
M-H		WIRE, ELECTRICAL MILW16878TYFEB22-925 (81349)	FT	REF										
M-H		WIRE, ELECTRICAL MILW16878TYFEB22-926 (81349)	FT	REF										
M-H		WIRE, ELECTRICAL MILW16878TYFEB22-935 (81349)	FT	REF										
M-H		WIRE, ELECTRICAL MILW16878TYFEB22-936 (81349)	FT	REF										
P-H		WIRE, ELECTRICAL MILW16878TYFEB22-956 (81349)	FT	16				*	*	*	*	*		
M-H		WIRE, ELECTRICAL MILW16878TYFEB22-902-3 (81349)	FT	REF										
M-H		WIRE, ELECTRICAL MILW16878TYFEB22-902-5 (81349)	FT	REF										
M-H		WIRE, ELECTRICAL MILW16878TYFEB22-902-6 (81349)	FT	REF										
P-F	5905-279-2643	RESISTOR, FIXED, COMPOSITION RC32GF101K (81349)	EA	1	*	*	*	*	*	*	*	*	3-20	A5A7R25
P-H		WIRE, ELECTRICAL MILW16878TYFEB22-9125 (81349)	FT	11				*	*	*	*	*		
P-H		WIRE, ELECTRICAL MILW16878TYFEB22-9126 (81349)	FT	13				*	*	*	*	*		
P-H		WIRE, ELECTRICAL MILW16878TYFEB22-9235 (81349)	FT	8				*	*	*	*	*		
P-H		WIRE, ELECTRICAL MILW16878TYFEB22-9236 (81349)	FT	7				*	*	*	*	*		
P-H		WIRE, ELECTRICAL MILW16878TYFEB22-9256 (81349)	FT	7				*	*	*	*	*		
P-H		WIRE, ELECTRICAL MILW16878TYFEB22-9356 (81349)	FT	6				*	*	*	*	*		
M-H		CABLE, SPECIAL PURPOSE, ELECTRICAL 1SBUB730N90 (90484)	FT	REF										
M-H		CABLE, SPECIAL PURPOSE, ELECTRICAL 1SBUB730N91 (90484)	FT	REF										
M-H		CABLE, SPECIAL PURPOSE, ELECTRICAL 1SBUB730N92 (90484)	FT	REF										
M-H		CABLE, SPECIAL PURPOSE, ELECTRICAL 1SBUB730N93 (90484)	FT	REF										
M-H		CABLE, RADIO FREQUENCY RG196AU (80050)	FT	REF										
M-H		INSULATION SLEEVING, ELECTRICAL TEFTW19B (81851)	FT	REF										
P-H		CORD, NYLON 435-1014-000 (13499)	FT	REF				*	*	*	*	*		
A-F		GENERATOR SUBASSEMBLY 542-7788-005 (13499)	EA	REF										

SECTION III REPAIR PARTS FOR DIRECT SUPPORT, GENERAL SUPPORT, AND DEPOT MAINTENANCE (CONTINUED)

(1) SIR CODE	(2) FEDERAL STOCK NUMBER	(3) DESCRIPTION  REFERENCE NUMBER & MFR. CODE	(4) UNIT OF MEAS	(5) QTY INC IN UNIT	(6) 30-DAY DS MAINT ALLOWANCE			(7) 30-DAY GS MAINT ALLOWANCE			(8) 1 YR ALM PER EQUIP CNTGNCY	(9) DEPOT MAINT ALM PER 100 EQUIP	(10) ILLUSTRATIONS	
					(a) 1-20	(b) 21-50	(c) 51-100	(a) 1-20	(b) 21-50	(c) 51-100			(a) FIG NO.	(b) ITEM NO. OR REFERENCE DESIGNATION
P-F	5935-993-2181	CONNECTOR, RECEPTACLE, ELECTRICAL DAF15S (71468)	EA	3	*	*	*	*	*	*	*	*	3-20	1A5A7J1
P-F	5935-993-2181	CONNECTOR, RECEPTACLE, ELECTRICAL DAF15S (71468)	EA	REF	*	*	*	*	*	*	*	*	3-20	1A5A7J2
P-F	5935-993-2181	CONNECTOR, RECEPTACLE, ELECTRICAL DAF15S (71468)	EA	REF	*	*	*	*	*	*	*	*	3-20	1A5A7J14
P-F	5935-577-8713	CONNECTOR, RECEPTACLE, ELECTRICAL 143-010-01 (02660)	EA	4	*	*	*	*	*	*	*	*	3-20	1A5A7J3
P-F	5935-577-8713	CONNECTOR, RECEPTACLE, ELECTRICAL 143-010-01 (02660)	EA	REF	*	*	*	*	*	*	*	*	3-20	1A5A7J4
P-F	5935-577-8713	CONNECTOR, RECEPTACLE, ELECTRICAL 143-010-01 (02660)	EA	REF	*	*	*	*	*	*	*	*	3-20	1A5A7J6
P-F	5935-577-8713	CONNECTOR, RECEPTACLE, ELECTRICAL 143-010-01 (02660)	EA	REF	*	*	*	*	*	*	*	*	3-20	1A5A7J7
P-F	5935-660-3558	CONNECTOR, RECEPTACLE, ELECTRICAL KXK12S (81312)	EA	1	*	*	*	*	*	*	*	*	3-20	1A5A7J5
M-H		INSULATION, SLEEVING, ELECTRICAL TEPTW11B (81891)	FT	REF										
P-F	5935-504-316	CONNECTOR, RECEPTACLE, ELECTRICAL 26-4402-16S (02660)	EA	1	*	*	*	*	*	*	*	*	3-22	1A5A7J12
P-F	5935-7419	CONNECTOR, RECEPTACLE, ELECTRICAL 26-4404-16S (02660)	EA	1	*	*	*	*	*	*	*	*	3-22	1A5A7J13
P-F	5935-681-4305	CONNECTOR, RECEPTACLE, ELECTRICAL 26-4405-16S (02660)	EA	1	*	*	*	*	*	*	*	*	3-22	1A5A7J11
P-F	5305-054-5648	SCREW, MACHINE MS51957-14 (96906)	EA	REF	*	*	*	*	*	*	*	*		
P-F	5310-058-3599	WASHER, LOCK MS35335-57 (96906)	EA	REF	*	*	*	*	*	*	*	*		
P-F	5310-934-9748	NUT, PLAIN, HEXAGON MS35649-44 (96906)	EA	REF	*	*	*	*	*	*	*	*		
X2-F		PLATE 544-2800-003 (13499)	EA	1										
P-F		NUT, CAPTIVE NCH6-2-2-1 (07886)	EA	REF	*	*	*	*	*	*	*	*		
X1-F		PLATE, RETAINING 544-2799-003 (13499)	EA	1										
P-F		TERMINAL, LUG 40C7-4BOTTINNED (77147)	EA	REF	*	*	*	*	*	*	*	*		
P-F		SCREW, MACHINE P343-0286-000 (77250)	EA	REF	*	*	*	*	*	*	*	*		
P-H	5310-559-7792	WASHER, LOCK AN936B4B (88044)	EA	REF	*	*	*	*	*	*	*	*		
P-F		NUT, PLAIN, HEXAGON P313-0051-000 (77250)	EA	REF	*	*	*	*	*	*	*	*		
F-F	5935-853-7596	CONNECTOR, RECEPTACLE, ELECTRICAL UG1094U (80058)	EA	3	*	*	*	*	*	*	*	*	3-22	1A5A7J8
P-F	5935-853-7596	CONNECTOR, RECEPTACLE, ELECTRICAL UG1094U (80058)	EA	REF	*	*	*	*	*	*	*	*	3-22	1A5A7J9
P-F	5935-853-7596	CONNECTOR, RECEPTACLE, ELECTRICAL UG1094U (80058)	EA	REF	*	*	*	*	*	*	*	*	3-22	1A5A7J10
P-F		CONNECTOR, RECEPTACLE, ELECTRICAL MS35179-1094A (96906)	EA	3	*	*	*	*	*	*	*	*	3-22	1A5A7J8
P-F		CONNECTOR, RECEPTACLE, ELECTRICAL MS35179-1094A (96906)	EA	REF	*	*	*	*	*	*	*	*	3-22	1A5A7J9
P-F		CONNECTOR, RECEPTACLE, ELECTRICAL MS35179-1094A (96906)	EA	REF	*	*	*	*	*	*	*	*	3-22	1A5A7J10

SECTION III REPAIR PARTS FOR DIRECT SUPPORT, GENERAL SUPPORT, AND DEPOT MAINTENANCE (CONTINUED)

(1) SRR CODE	(2) FEDERAL STOCK NUMBER	(3) DESCRIPTION  REFERENCE NUMBER & MFR. CODE	(4) UNIT OF MEAS	(5) QTY INC IN UNIT	(6) 30-DAY DS MAINT ALLOWANCE			(7) 30-DAY GS MAINT ALLOWANCE			(8) 1 YR ALW PER EQUIP CWTGCT	(9) DEPOT MAINT ALW PER 100 EQUIP	(10) ILLUSTRATIONS	
					(a) 1-20	(b) 21-50	(c) 51-100	(a) 1-20	(b) 21-50	(c) 51-100			(a) FIG NO.	(b) ITEM NO. OR REFERENCE DESIGNATION
P-F	5910-615-4101	CAPACITOR, FIXED, CERAMIC DIELECTRIC 327-029X5T0102Z (72982)	EA	35	*	*	*	*	*	*	*	*	3-20	1A5A7C1
P-F	5910-615-4101	CAPACITOR, FIXED, CERAMIC DIELECTRIC 327-029X5T0102Z (72982)	EA	REF	*	*	*	*	*	*	*	*	3-20	1A5A7C2
P-F	5910-615-4101	CAPACITOR, FIXED, CERAMIC DIELECTRIC 327-029X5T0102Z (72982)	EA	REF	*	*	*	*	*	*	*	*	3-20	1A5A7C3
P-F	5910-615-4101	CAPACITOR, FIXED, CERAMIC DIELECTRIC 327-029X5T0102Z (72982)	EA	REF	*	*	*	*	*	*	*	*	3-20	1A5A7C4
P-F	5910-615-4101	CAPACITOR, FIXED, CERAMIC DIELECTRIC 327-029X5T0102Z (72982)	EA	REF	*	*	*	*	*	*	*	*	3-20	1A5A7C5
P-F	5910-615-4101	CAPACITOR, FIXED, CERAMIC DIELECTRIC 327-029X5T0102Z (72982)	EA	REF	*	*	*	*	*	*	*	*	3-20	1A5A7C6
P-F	5910-615-4101	CAPACITOR, FIXED, CERAMIC DIELECTRIC 327-029X5T0102Z (72982)	EA	REF	*	*	*	*	*	*	*	*	3-20	1A5A7C7
P-F	5910-615-4101	CAPACITOR, FIXED, CERAMIC DIELECTRIC 327-029X5T0102Z (72982)	EA	REF	*	*	*	*	*	*	*	*	3-20	1A5A7C8
P-F	5910-615-4101	CAPACITOR, FIXED, CERAMIC DIELECTRIC 327-029X5T0102Z (72982)	EA	REF	*	*	*	*	*	*	*	*	3-20	1A5A7C9
P-F	5910-615-4101	CAPACITOR, FIXED, CERAMIC DIELECTRIC 327-029X5T0102Z (72982)	EA	REF	*	*	*	*	*	*	*	*	3-20	1A5A7C10
P-F	5910-615-4101	CAPACITOR, FIXED, CERAMIC DIELECTRIC 327-029X5T0102Z (72982)	EA	REF	*	*	*	*	*	*	*	*	3-20	1A5A7C11
P-F	5910-615-4101	CAPACITOR, FIXED, CERAMIC DIELECTRIC 327-029X5T0102Z (72982)	EA	REF	*	*	*	*	*	*	*	*	3-20	1A5A7C12
P-F	5910-615-4101	CAPACITOR, FIXED, CERAMIC DIELECTRIC 327-029X5T0102Z (72982)	EA	REF	*	*	*	*	*	*	*	*	3-20	1A5A7C13
P-F	5910-615-4101	CAPACITOR, FIXED, CERAMIC DIELECTRIC 327-029X5T0102Z (72982)	EA	REF	*	*	*	*	*	*	*	*	3-20	1A5A7C14
P-F	5910-615-4101	CAPACITOR, FIXED, CERAMIC DIELECTRIC 327-029X5T0102Z (72982)	EA	REF	*	*	*	*	*	*	*	*	3-20	1A5A7C15
P-F	5910-615-4101	CAPACITOR, FIXED, CERAMIC DIELECTRIC 327-029X5T0102Z (72982)	EA	REF	*	*	*	*	*	*	*	*	3-20	1A5A7C16
P-F	5910-615-4101	CAPACITOR, FIXED, CERAMIC DIELECTRIC 327-029X5T0102Z (72982)	EA	REF	*	*	*	*	*	*	*	*	3-20	1A5A7C17
P-F	5910-615-4101	CAPACITOR, FIXED, CERAMIC DIELECTRIC 327-029X5T0102Z (72982)	EA	REF	*	*	*	*	*	*	*	*	3-20	1A5A7C18
P-F	5910-615-4101	CAPACITOR, FIXED, CERAMIC DIELECTRIC 327-029X5T0102Z (72982)	EA	REF	*	*	*	*	*	*	*	*	3-20	1A5A7C19
P-F	5910-615-4101	CAPACITOR, FIXED, CERAMIC DIELECTRIC 327-029X5T0102Z (72982)	EA	REF	*	*	*	*	*	*	*	*	3-20	1A5A7C20
P-F	5910-615-4101	CAPACITOR, FIXED, CERAMIC DIELECTRIC 327-029X5T0102Z (72982)	EA	REF	*	*	*	*	*	*	*	*	3-20	1A5A7C21
P-F	5910-615-4101	CAPACITOR, FIXED, CERAMIC DIELECTRIC 327-029X5T0102Z (72982)	EA	REF	*	*	*	*	*	*	*	*	3-20	1A5A7C22
P-F	5910-615-4101	CAPACITOR, FIXED, CERAMIC DIELECTRIC 327-029X5T0102Z (72982)	EA	REF	*	*	*	*	*	*	*	*	3-20	1A5A7C23
P-F	5910-615-4101	CAPACITOR, FIXED, CERAMIC DIELECTRIC 327-029X5T0102Z (72982)	EA	REF	*	*	*	*	*	*	*	*	3-20	1A5A7C24
P-F	5910-615-4101	CAPACITOR, FIXED, CERAMIC DIELECTRIC 327-029X5T0102Z (72982)	EA	REF	*	*	*	*	*	*	*	*	3-20	1A5A7C25
P-F	5910-615-4101	CAPACITOR, FIXED, CERAMIC DIELECTRIC 327-029X5T0102Z (72982)	EA	REF	*	*	*	*	*	*	*	*	3-20	1A5A7C26
P-F	5910-615-4101	CAPACITOR, FIXED, CERAMIC DIELECTRIC 327-029X5T0102Z (72982)	EA	REF	*	*	*	*	*	*	*	*	3-20	1A5A7C27

SECTION III REPAIR PARTS FOR DIRECT SUPPORT, GENERAL SUPPORT, AND DEPOT MAINTENANCE (CONTINUED)

(1) SQR CODE	(2) FEDERAL STOCK NUMBER	(3) DESCRIPTION  USABLE ON CODE	(4) UNIT OF MEAS	(5) QTY INC IN UNIT	(6) 30-DAY DS MAINT ALLOWANCE			(7) 30-DAY GS MAINT ALLOWANCE			(8) 1 YR ALW PER EQUIP CNTGCTY	(9) DEPOT MAINT ALW PER 100 EQUIP	(10) ILLUSTRATIONS	
					(a)	(b)	(c)	(a)	(b)	(c)			(a)	(b)
					1-20	21-50	51-100	1-20	21-50	51-100			FIG NO.	ITEM NO. OR REFERENCE DESIGNATION
P-F	5910-615-4101	CAPACITOR, FIXED, CERAMIC DIELECTRIC 327-029X5T0102Z (72982)	EA	REF	*	*	*	*	*	*	*	*	3-20	1A5A7C28
P-F	5910-615-4101	CAPACITOR, FIXED, CERAMIC DIELECTRIC 327-029X5T0102Z (72982)	EA	REF	*	*	*	*	*	*	*	*	3-20	1A5A7C29
P-F	5910-615-04101	CAPACITOR, FIXED, CERAMIC DIELECTRIC 327-029X5T0102Z (72982)	EA	REF	*	*	*	*	*	*	*	*	3-20	1A5A7C30
P-F	5901-615-4101	CAPACITOR, FIXED, CERAMIC DIELECTRIC 327-029X5T0102Z (72982)	EA	REF	*	*	*	*	*	*	*	*	3-20	1A5A7C31
P-F	5910-615-4101	CAPACITOR, FIXED, CERAMIC DIELECTRIC 327-029X5T0102Z (72982)	EA	REF	*	*	*	*	*	*	*	*	3-20	1A5A7C32
P-F	5910-615-4101	CAPACITOR, FIXED, CERAMIC DIELECTRIC 327-029X5T0102Z (72982)	EA	REF	*	*	*	*	*	*	*	*	3-20	1A5A7C33
P-F	5910-615-4101	CAPACITOR, FIXED, CERAMIC DIELECTRIC 327-029X5T0102Z (72982)	EA	REF	*	*	*	*	*	*	*	*	3-20	1A5A7C34
P-F	5910-615-4101	CAPACITOR, FIXED, CERAMIC DIELECTRIC 327-029X5T0102Z (72982)	EA	REF	*	*	*	*	*	*	*	*	3-20	1A5A7C35
P-F		NUT, PLAIN, HEXAGON P313-0149-000 (77250)	EA	REF	*	*	*	*	*	*	*	*		
P-F		WASHER, LOCK 1714-050ADFL (78189)	EA	REF	*	*	*	*	*	*	*	*		
P-H		SCREW, MACHINE P343-0287-000 (77250)	EA	20				*	*	*	*	*		
X2-F		RETAINER 544-2798-003 (13499)	EA	1										
P-F		NUT, PLAIN, HEXAGON P313-0140-000 (77250)	EA	REF	*	*	*	*	*	*	*	*		
P-F	5310-167-0847	WASHER, LOCK AN9368B (88044)	EA	REF	*	*	*	*	*	*	*	*		
P-F		SCREW, MACHINE P343-0328-000 (77250)	EA	45				*	*	*	*	*		
P-F		TERMINAL, LUG 2104-06-02-2520H (78189)	EA	REF	*	*	*	*	*	*	*	*		
P-F		BUTTON 541-5180-002 (13499)	EA	1	*	*	*	*	*	*	*	*		
P-F	5940-812-1668	FERRULE, RADIO FREQUENCY, GROUNDING G5B063 (59730)	EA	4	*	*	*	*	*	*	*	*		
P-F	5940-280-3829	FERRULE, RADIO FREQUENCY, GROUNDING G5C128 (59730)	EA	16	*	*	*	*	*	*	*	*		
P-F	5935-965-5571	ALPATER, CABLE YE1620F32 (09922)	EA	REF	*	*	*	*	*	*	*	*		
M-H		INSULATION SLEEVING, ELECTRICAL TEFTW10B (81851)	FT	REF	*	*	*	*	*	*	*	*		
P-F		INSULATION SLEEVING, ELECTRICAL TEFTW22B (81851)	FT	REF	*	*	*	*	*	*	*	*		
M-H		WIRE, ELECTRICAL 00702-1322 (70567)	FT	REF	*	*	*	*	*	*	*	*		
M-H		WIRE, ELECTRICAL MILW16878TYPE22-9 (81349)	FT	REF	*	*	*	*	*	*	*	*		
P-F	5910-553-4994	CAPACITOR, FIXED, PAPER DIELECTRIC SDB1K02474M (53021)	EA	1	*	*	*	*	*	*	*	*		1A5A7C36
M-H		WIRE, ELECTRICAL MILW16878TYPE22-905 (81349)	FT	REF	*	*	*	*	*	*	*	*		
P-F	5905-954-2517	RESISTOR, FIXED, FILM RN65D1783F (81349)	EA	1	*	*	*	*	*	*	*	*		1A5A7C17

SECTION III REPAIR PARTS FOR DIRECT SUPPORT, GENERAL SUPPORT, AND DEPOT MAINTENANCE (CONTINUED)

(1) SR CODE	(2) FEDERAL STOCK NUMBER	(3) DESCRIPTION  REFERENCE NUMBER & MFR. CODE	(4) UNIT OF MEAS	(5) QTY INC IN UNIT	(6) 30-DAY DS MAINT ALLOWANCE			(7) 30-DAY GS MAINT ALLOWANCE			(8) 1 YR ALW PER EQUIP C/TOTY	(9) DEPOT MAINT ALW PER 100 EQUIP	(10) ILLUSTRATIONS	
					(a)	(b)	(c)	(a)	(b)	(c)			(a)	(b)
					1-20	21-50	51-100	1-20	21-50	51-100			FIG NO.	ITEM NO. OR REFERENCE DESIGNATION
P-F	5305-054-5650	SCREW, MACHINE MS51957-16 (96906)	EA	REF	*	*	*	*	*	*	*			
P-F		SPACER, CONNECTOR 543-3538-002 (13499)	EA	6	*	*	*	*	*	*	*			
P-F	5305-054-5646	SCREW, MACHINE MS51959-21 (96906)	EA	REF	*	*	*	*	*	*	*			
M-H		INSULATION SLEEVING, ELECTRICAL 152-1743-000 (13499)	FT	4										
P-F	5310-058-3829	WASHER, LOCK MS35338-77 (96906)	EA	REF	*	*	*	*	*	*	*			
P-F	5305-763-3357	SCREW, MACHINE MS51959-6 (96906)	EA	REF	*	*	*	*	*	*	*			
P-F	5355-668-5311	KNOB 1450WBLK (72512)	EA	2	*	*	*	*	*	*	*		1A5A704	
P-F	5355-668-5311	KNOB 1450WBLK (72512)	EA	REF	*	*	*	*	*	*	*		1A5A705	
M-H		INSULATION SLEEVING, ELECTRICAL 152-1736-000 (13499)	FT	3										
P-F	5945-679-9457	RELAY, ARMATURE MG1165-1 (77342)	EA	1	*	*	*	*	*	*	*	3-20	1A5A7K2	
P-F	5930-050-2680	SWITCH, TOGGLE ST42A (81350)	EA	1	*	*	*	*	*	*	*	3-21	1A5A7S4	
P-F		WASHER, LOCK 1724-02CADPL (78189)	EA	4	*	*	*	*	*	*	*			
P-F	5930-655-1508	SWITCH, TOGGLE MS25100-23 (96906)	EA	1	*	*	*	*	*	*	*	3-21	1A5A7S5	
P-H	5905-171-1986	RESISTOR, FIXED, COMPOSITION RC20GF563J (81349)	EA	3	*	*	*	*	*	*	*	3-20	1A5A7R22	
P-H	5905-171-1986	RESISTOR, FIXED, COMPOSITION RC20GF563J (81349)	EA	REF	*	*	*	*	*	*	*	3-20	1A5A7R23	
P-H	5905-171-1986	RESISTOR, FIXED, COMPOSITION RC20GF563J (81349)	EA	REF	*	*	*	*	*	*	*	3-20	1A5A7R24	
P-F	5305-054-5648	SCREW, MACHINE MS51957-14 (96906)	EA	REF	*	*	*	*	*	*	*			
P-F	5905-185-8516	RESISTOR, FIXED, COMPOSITION RC42GF103K (81349)	EA	1	*	*	*	*	*	*	*		1A5A7R31	
P-F	5940-500-7227	TERMINAL, LUG 31-759 (02660)	EA	5	*	*	*	*	*	*	*			
M-H		INSULATION SLEEVING, ELECTRICAL TEFTW17B (81851)	FT	3										
M-H		INSULATION SLEEVING, ELECTRICAL TEFTW10B (81851)	FT	REF										
M-H		INSULATION SLEEVING, ELECTRICAL TEFT11B (81851)	FT	REF										
M-H		INSULATION SLEEVING, ELECTRICAL TEFTW9B (81851)	FT	2										
M-H		INSULATION SLEEVING, ELECTRICAL TEFTW19B (81851)	FT	REF										
P-H	5305-054-5636	SCREW, MACHINE MS51957-2 (96906)	EA	REF	*	*	*	*	*	*	*			
A-F		COVER, GENERATOR 543-2857-005 (13499)	EA	2										
XI-F		COVER, GENERATOR 543-2856-005 (13499)	EA	2										

SECTION III REPAIR PARTS FOR DIRECT SUPPORT, GENERAL SUPPORT, AND DEPOT MAINTENANCE (CONTINUED)

(1) SIB CODE	(2) FEDERAL STOCK NUMBER	(3) DESCRIPTION  USABLE ON CODE	(4) UNIT OF MEAS	(5) QTY INC IN UNIT	(6) 30-DAY DS MAINT ALLOWANCE			(7) 30-DAY GS MAINT ALLOWANCE			(8) 1 YR ALW PER EQUIP CNTGCT	(9) DEPOT MAINT ALW PER 100 EQUIP	(10) ILLUSTRATIONS	
					(a) 1-20	(b) 21-50	(c) 51-100	(a) 1-20	(b) 21-50	(c) 51-100			(a) FIG NO.	(b) ITEM NO. OR REFERENCE DESIGNATION
					X1-F		CATCH, FLUSH H460D040-250 (83014)	EA	10					
X2-F		RIVET, TUBULAR R4008X1-8CHROMATEPL (12014)	EA	REF										
X2-F		COVER, AUDIO 543-2851-004 (13499)	EA	2										
X2-F		COVER, REAR 543-2849-004 (13499)	EA	2										
A-F		AMPLIFIER 543-0274-005 (13499)	EA	1								3-18	1A5A5	
P-F	5960-264-1028	SHIELD, ELECTRON 141-0223-000 (13499)	EA	1	*	*	*	*	*	*	*	*	*	1A5A5E1
M-H		INSULATION SLEEVING, ELECTRICAL TEFTW20B (81851)	EA	REF										
M-H		INSULATION SLEEVING, ELECTRICAL 152-1736-000 (13499)	EA	REF										
P-F		INSULATION SLEEVING, ELECTRICAL TEFTW22B (81851)	EA	REF	*	*	*	*	*	*	*	*	*	
P-F		EYELET, METALLIC SE2 SHOTTINMED (61957)	EA	REF	*	*	*	*	*	*	*	*	*	
M-H		INSULATION SLEEVING, ELECTRICAL TEFTW22-3 (81851)	FT	REF										
M-H		INSULATION SLEEVING, ELECTRICAL TEFTW22-1 (81851)	FT	REF										
M-H		INSULATION SLEEVING, ELECTRICAL TEFTW22-0 (81851)	FT	REF										
X1-H		INSULATION SLEEVING, ELECTRICAL TEFTW22-6 (81851)	FT	REF										
M-H		INSULATION SLEEVING, ELECTRICAL TEFTW22-5 (81851)	FT	REF										
M-H		INSULATION SLEEVING, ELECTRICAL TEFTW22-4 (81851)	FT	REF										
P-H	5910-057-5218	CAPACITOR, FIXED, ELECTROLYTIC CL25BJ180TP3 (81349)	EA	1				*	*	*	*	*	3-24	1A5A5C20
P-F	5910-269-4613	CAPACITOR, FIXED, ELECTROLYTIC CL25BQ040SP3 (81349)	EA	1	*	*	*	*	*	*	*	*	3-23	1A5A5C16
P-F	5910-992-2070	CAPACITOR, FIXED, ELECTROLYTIC 150D606X000682 (56289)	EA	2	*	*	*	*	*	*	*	*	3-24	1A5A5C21
P-F	5910-992-2070	CAPACITOR, FIXED, ELECTROLYTIC 150D606X000682 (56289)	EA	REF	*	*	*	*	*	*	*	*	3-24	1A5A5C22
P-H	5910-679-9388	CAPACITOR, FIXED, ELECTROLYTIC 150D224X0035A2 (56289)	EA	1	*	*	*	*	*	*	*	*	3-23	1A5A5C23
P-F	5910-542-7371	CAPACITOR, FIXED, ELECTROLYTIC 150D225X0020A2 (56289)	EA	1	*	*	*	*	*	*	*	*	3-23	1A5A5C24
P-H	5960-230-5226	ELECTRON TUBE 5636 (82219)	EA	1				*	*	*	*	*	3-24	1A5A5V3
P-H	5960-256-9989	ELECTRON TUBE 5899 (82219)	EA	3				*	*	*	*	*	3-23	1A5A5V1
P-H	5960-256-9989	ELECTRON TUBE 5899 (82219)	EA	REF				*	*	*	*	*	3-24	1A5A5V2
P-H	5960-256-9989	ELECTRON TUBE 5899 (82219)	EA	REF				*	*	*	*	*	3-24	1A5A5V4

SECTION III REPAIR PARTS FOR DIRECT SUPPORT, GENERAL SUPPORT, AND DEPOT MAINTENANCE (CONTINUED)

(1) SIR CODE	(2) FEDERAL STOCK NUMBER	(3) DESCRIPTION  REFERENCE NUMBER & MFR. CODE	(4) UNIT OF MEAS	(5) QTY INC IN UNIT	(6) 30-DAY DS MAINT ALLOWANCE			(7) 30-DAY GS MAINT ALLOWANCE			(8) 1 YR ALW PER EQUIP CATGCTY	(9) DEPOT MAINT ALW PER 100 EQUIP	(10) ILLUSTRATIONS	
					(a) 1-20	(b) 21-50	(c) 51-100	(a) 1-20	(b) 21-50	(c) 51-100			(a) FIG NO.	(b) ITEM NO. OR REFERENCE DESIGNATION
P-F	5305-054-5647	SCREW, MACHINE MS51957-13 (96906)	EA	REF	*	*	*	*	*	*	*	*		
P-F	5310-595-5421	WASHER, FLAT 310-6320-000 (79807)	EA	REF	*	*	*	*	*	*	*	*		
P-H	5310-622-1724	NUT, SELF-LOCKING, HEXAGON 68-1660-26 (72962)	EA	REF				*	*	*	*	*		
P-H	5310-614-3500	NUT, SELF-LOCKING, HEXAGON 68-166J-40 (72962)	EA	REF				*	*	*	*	*		
P-F	5305-770-2533	SCREW, MACHINE MS51959-13 (96906)	EA	REF	*	*	*	*	*	*	*	*		
P-F	5305-763-7822	SCREW, MACHINE MS51959-14 (96906)	EA	REF	*	*	*	*	*	*	*	*		
P-F	5305-727-8833	SCREW, MACHINE MS51959-3 (96906)	EA	REF	*	*	*	*	*	*	*	*		
P-H	5305-054-5636	SCREW, MACHINE MS51957-2 (96906)	EA	REF				*	*	*	*	*		
P-F	5305-054-5640	SCREW, MACHINE MS51957-6 (96906)	EA	14	*	*	*	*	*	*	*	*		
P-H	5961-818-4487	TRANSISTOR 2N1150 (07688)	EA	1				*	*	*	*	*	3-24	1A5A5Q1
P-F	5961-553-7012	TRANSISTOR 2N243 (07688)	EA	2	*	*	*	*	*	*	*	*	3-24	1A5A5Q2
P-F	5961-553-7012	TRANSISTOR 2N243 (07688)	EA	REF	*	*	*	*	*	*	*	*	3-24	1A5A5Q3
P-H	5935-057-2690	CONNECTOR, RECEPTACLE, ELECTRICAL DAL5P (71468)	EA	1				*	*	*	*	*	3-23	1A5A5P1
P-F	5905-556-7917	RESISTOR, VARIABLE 3010L1-102 (80294)	EA	1	*	*	*	*	*	*	*	*		1A5A5R33
P-H	5961-866-0476	SEMICONDUCTOR DEVICE, DIODE 1N457 (07688)	EA	2				*	*	*	*	*	3-24	1A5A5CR1
P-H	5961-866-0476	SEMICONDUCTOR DEVICE, DIODE 1N457 (07688)	EA	REF				*	*	*	*	*	3-24	1A5A5CR2
M-H		WIRE, ELECTRICAL 00702-1322 (70567)	FT	REF										
M-H		CABLE, RADIO FREQUENCY RG196AU (80058)	FT	REF										
M-H		WIRE, ELECTRICAL MILW16878TYPE22-9 (81349)	FT	REF										
M-H		WIRE, ELECTRICAL MILW16878TYPE22-90 (81349)	FT	REF										
M-H		WIRE, ELECTRICAL MILW16878TYPE22-91 (81349)	FT	REF										
P-H		WIRE, ELECTRICAL MILW16878TYPE22-96 (81349)	FT	4				*	*	*	*	*		
P-H		WIRE, ELECTRICAL MILW16878TYPE22-905 (81349)	FT	3				*	*	*	*	*		
P-H		WIRE, ELECTRICAL MILW16878TYPE22-906 (81349)	FT	3				*	*	*	*	*		
P-H		WIRE, ELECTRICAL MILW16878TYPE22-912 (81349)	FT	6				*	*	*	*	*		
P-H		WIRE, ELECTRICAL MILW16878TYPE22-915 (81349)	FT	3				*	*	*	*	*		
M-H		WIRE, ELECTRICAL MILW16878TYPE22-0 (81349)	FT	REF										



SECTION III REPAIR PARTS FOR DIRECT SUPPORT, GENERAL SUPPORT, AND DEPOT MAINTENANCE (CONTINUED)

(1) SR CODE	(2) FEDERAL STOCK NUMBER	(3) DESCRIPTION  REFERENCE NUMBER in REF. CODE	(4) UNIT OF MEAS	(5) QTY INC IN UNIT	(6) 30-DAY DS MAINT ALLOWANCE						(7) 30-DAY GS MAINT ALLOWANCE			(8) 1 YR ALW PER EQUIP CNTGCT	(9) DEPOT MAINT ALW PER 100 EQUIP	(10) ILLUSTRATIONS				
					(a)			(b)			(c)					(a)	(b)	(c)	(a) FIG NO.	(b) ITEM NO. OR REFERENCE DESIGNATION
					1-20	21-50	51-100	1-20	21-50	51-100	1-20	21-50	51-100							
P-F	5915-615-3952	FILTER, BANDPASS 526-9312-000 (13499)	EA	1	*	*	*	*	*	*	*	*	*	*	3-23	1A5A5FL1				
A-F		SHIELD ASSEMBLY 542-4782-002 (13499)	EA	3											3-24	1A5A5E2				
A-F		SHIELD ASSEMBLY 542-4782-002 (13499)	EA	REF											3-24	1A5A5E3				
A-F		SHIELD ASSEMBLY 542-4782-002 (13499)	EA	REF											3-24	1A5A5E4				
P-F		RETAINER 542-0371-002 (13499)	EA	REF	*	*	*	*	*	*	*	*	*	*						
P-F		SHIELD, ELECTRON 542-0375-002 (13499)	EA	REF	*	*	*	*	*	*	*	*	*	*						
XI-F		SHIELD, EXTRUDED 542-0378-012 (13499)	EA	REF																
M-H		INSULATION SLEEVING, ELECTRICAL TEFTW16B (81851)	FT	REF																
P-F	5950-055-9626	TRANSFORMER, AUDIO FREQUENCY TS3703 (95088)	EA	1	*	*	*	*	*	*	*	*	*	*	3-23	1A5A5T2				
P-F	5950-615-0727	TRANSFORMER, AUDIO FREQUENCY 526-6930-000 (13499)	EA	1	*	*	*	*	*	*	*	*	*	*	3-24	1A5A5T3				
P-H	5905-279-1756	RESISTOR, FIXED, COMPOSITION RC20GF151K (81349)	EA	1	*	*	*	*	*	*	*	*	*	*	3-24	1A5A5R3				
P-F	5905-171-1997	RESISTOR, FIXED, COMPOSITION RC20GF331K (81349)	EA	1	*	*	*	*	*	*	*	*	*	*	3-23	1A5A5R12				
P-F	5905-245-0023	RESISTOR, FIXED, COMPOSITION RC20GF682K (81349)	EA	1	*	*	*	*	*	*	*	*	*	*	3-24	1A5A5R17				
P-F	5905-141-0591	RESISTOR, FIXED, COMPOSITION RC20GF103K (81349)	EA	1	*	*	*	*	*	*	*	*	*	*	3-23	1A5A5R27				
P-H	5905-279-2029	RESISTOR, FIXED, COMPOSITION RC20GF223K (81349)	EA	2	*	*	*	*	*	*	*	*	*	*	3-23	1A5A5R2				
P-H	5905-279-2029	RESISTOR, FIXED, COMPOSITION RC20GF223K (81349)	EA	REF											3-23	1A5A5R5				
P-H	5905-171-1986	RESISTOR, FIXED, COMPOSITION RC20GF963J (81349)	EA	1	*	*	*	*	*	*	*	*	*	*	3-23	1A5A5R24				
P-F	5905-295-3410	RESISTOR, FIXED, COMPOSITION RC20GF473K (81349)	EA	3	*	*	*	*	*	*	*	*	*	*	3-24	1A5A5R9				
P-F	5905-259-3410	RESISTOR, FIXED, COMPOSITION RC20GF473K (81349)	EA	REF	*	*	*	*	*	*	*	*	*	*	3-24	1A5A5R13				
P-F	5905-295-3410	RESISTOR, FIXED, COMPOSITION RC20GF473K (81349)	EA	REF	*	*	*	*	*	*	*	*	*	*	3-23	1A5A5R30				
P-H	5905-192-3987	RESISTOR, FIXED, COMPOSITION RC20GF104K (81349)	EA	1	*	*	*	*	*	*	*	*	*	*	3-23	1A5A5R10				
P-H	5905-106-9348	RESISTOR, FIXED, COMPOSITION RC20GF154K (81349)	EA	1	*	*	*	*	*	*	*	*	*	*	3-24	1A5A5R16				
P-H	5905-192-0662	RESISTOR, FIXED, COMPOSITION RC20GF184K (81349)	EA	1	*	*	*	*	*	*	*	*	*	*	3-23	1A5A5R15				
P-F	5905-834-2961	RESISTOR, FIXED, COMPOSITION EB4305 (01121)	EA	1	*	*	*	*	*	*	*	*	*	*	3-23	1A5A5R25				
P-F	5905-192-0390	RESISTOR, FIXED, COMPOSITION RC20GF105K (81349)	EA	1	*	*	*	*	*	*	*	*	*	*	3-23	1A5A5R26				
P-F	5905-114-5388	RESISTOR, FIXED, COMPOSITION RC20GF220K (81349)	EA	2	*	*	*	*	*	*	*	*	*	*	3-23	1A5A5R22				
P-F	5905-114-5388	RESISTOR, FIXED, COMPOSITION RC20GF220K (81349)	EA	REF	*	*	*	*	*	*	*	*	*	*	3-23	1A5A5R23				

SECTION III REPAIR PARTS FOR DIRECT SUPPORT, GENERAL SUPPORT, AND DEPOT MAINTENANCE (CONTINUED)

(1) SRR CODE	(2) FEDERAL STOCK NUMBER	(3) DESCRIPTION  REFERENCE NUMBER & MFR. CODE	(4) UNIT OF MEAS  USABLE ON CODE	(5) QTY INC IN UNIT	(6) 30-DAY DS MAINT ALLOWANCE			(7) 30-DAY GS MAINT ALLOWANCE			(8) 1 YR ALW PER EQUIP CMTGCT	(9) DEPOT MAINT ALW PER 100 EQUIP	(10) ILLUSTRATIONS	
					(a) 1-20	(b) 21-50	(c) 51-100	(a) 1-20	(b) 21-50	(c) 51-100			(a) FIG NO.	(b) ITEM NO. OR REFERENCE DESIGNATION
					P-F	5905-106-9344	RESISTOR, FIXED, COMPOSITION RC20GF101J (81349)	EA	1	*			*	*
P-H	5905-249-4248	RESISTOR, FIXED, COMPOSITION RC20GF333K (81349)	EA	1	*	*	*	*	*	*	*	3-24	1A5A5R28	
P-F	5905-141-1311	RESISTOR, FIXED, COMPOSITION RC32GF202J (81349)	EA	1	*	*	*	*	*	*	*	3-23	1A5A5R19	
P-F	5905-133-0381	RESISTOR, FIXED, COMPOSITION RC32GF562K (81349)	EA	3	*	*	*	*	*	*	*	3-23	1A5A5R4	
P-F	5905-133-0381	RESISTOR, FIXED, COMPOSITION RC32GF562K (81349)	EA	REF	*	*	*	*	*	*	*	3-23	1A5A5R7	
P-F	5905-133-0381	RESISTOR, FIXED, COMPOSITION RC32GF562K (81349)	EA	REF	*	*	*	*	*	*	*	3-23	1A5A5R29	
P-F	5905-299-2025	RESISTOR, FIXED, COMPOSITION RC32GF123K (81349)	EA	1	*	*	*	*	*	*	*	3-24	1A5A5R14	
P-F	5905-253-1231	RESISTOR, FIXED, COMPOSITION RC42GF391K (81349)	EA	1	*	*	*	*	*	*	*	3-23	1A5A5R2C	
P-F	5910-071-1642	CAPACITOR, SELECT FROM CAPACITOR, FIXED, MICA DIELECTRIC CM05E2000J (81349)	EA	1	*	*	*	*	*	*	*	3-23	1A5A5C8	
P-F	5910-811-5919	OR - CAPACITOR, FIXED, MICA DIELECTRIC DM15E86000500WV4CR (72136)	EA	1	*	*	*	*	*	*	*	3-23	1A5A5C8	
P-F	5910-061-7453	OR - CAPACITOR, FIXED, MICA DIELECTRIC DM15E89000500WV4CR (72136)	EA	1	*	*	*	*	*	*	*	3-23	1A5A5C8	
P-F	5910-781-7929	OR - CAPACITOR, FIXED, MICA DIELECTRIC CM05F1000J (81349)	EA	1	*	*	*	*	*	*	*	3-23	1A5A5C8	
P-F	5910-990-5413	OR - CAPACITOR, FIXED, MICA DIELECTRIC DM15E960F0500WV4CR (72136)	EA	1	*	*	*	*	*	*	*	3-23	1A5A5C8	
P-F	5910-044-4963	OR - CAPACITOR, FIXED, MICA DIELECTRIC DM15E101F0300WV4CR (72136)	EA	1	*	*	*	*	*	*	*	3-23	1A5A5C8	
P-F	5910-810-8264	OR - CAPACITOR, FIXED, MICA DIELECTRIC DM15E1050F0500WV4CR (72136)	EA	1	*	*	*	*	*	*	*	3-23	1A5A5C8	
P-F	5910-854-8543	OR - CAPACITOR, FIXED, MICA DIELECTRIC DM15E1070F0300WV4CR (72136)	EA	1	*	*	*	*	*	*	*	3-23	1A5A5C8	
P-F	5910-027-9964	OR - CAPACITOR, FIXED, MICA DIELECTRIC DM15E110F0300WV4CR (72136)	EA	1	*	*	*	*	*	*	*	3-23	1A5A5C8	
P-F	5910-080-3688	OR - CAPACITOR, FIXED, MICA DIELECTRIC DM15E114CG0500WV4CR (72136)	EA	1	*	*	*	*	*	*	*	3-23	1A5A5C8	
P-F	5910-954-5504	OR - CAPACITOR, FIXED, MICA DIELECTRIC CM05F12100J (81349)	EA	1	*	*	*	*	*	*	*	3-23	1A5A5C8	
P-H	5910-681-7140	CAPACITOR, FIXED, MICA DIELECTRIC 22H5T18EG (14655)	EA	1	*	*	*	*	*	*	*	3-23	1A5A5C5	
P-F	5910-683-7478	CAPACITOR, FIXED, MICA DIELECTRIC 22H5T3EG (14655)	EA	1	*	*	*	*	*	*	*	3-24	1A5A5C27	
P-F	5910-984-5253	CAPACITOR, FIXED, MICA DIELECTRIC 22H5T33EG (14655)	EA	1	*	*	*	*	*	*	*	3-24	1A5A5C25	
P-F	5910-060-9619	CAPACITOR, FIXED, MICA DIELECTRIC 22H5T51EG (14655)	EA	2	*	*	*	*	*	*	*	3-24	1A5A5C11	
P-F	5910-060-9619	CAPACITOR, FIXED, MICA DIELECTRIC 22H5T51EG (14655)	EA	REF	*	*	*	*	*	*	*	3-24	1A5A5C14	
P-F	5910-800-0357	CAPACITOR, FIXED, PAPER DIELECTRIC 186F15391S3 (56289)	EA	2	*	*	*	*	*	*	*	3-23	1A5A5C2	
P-F	5910-800-0357	CAPACITOR, FIXED, PAPER DIELECTRIC 186F15391S3 (56289)	EA	REF	*	*	*	*	*	*	*	3-23	1A5A5C7	

SECTION III REPAIR PARTS FOR DIRECT SUPPORT, GENERAL SUPPORT, AND DEPOT MAINTENANCE (CONTINUED)

(1) SQR CODE	(2) FEDERAL STOCK NUMBER	(3) DESCRIPTION  REFERENCE NUMBER & MFR. CODE	(4) UNIT OF MEAS	(5) QTY INC IN UNIT	(6) 30-DAY DS MAINT ALLOWANCE			(7) 30-DAY GS MAINT ALLOWANCE			(8) 1 YR ALW PER EQUIP CNTGCTY	(9) DEPOT MAINT ALW PER 100 EQUIP	(10) ILLUSTRATIONS	
					(a)	(b)	(c)	(a)	(b)	(c)			(a)	(b)
					1-20	21-50	51-100	1-20	21-50	51-100			FIG NO.	ITEM NO. OR REFERENCE DESIGNATION
P-H	5910-835-2175	CAPACITOR, FIXED, PAPER DIELECTRIC SDBIK01103M (53021)	EA	4				*	*	*	*	*	3-23	1A5A5C1
P-H	5910-835-2175	CAPACITOR, FIXED, PAPER DIELECTRIC SDBIK01103M (53021)	EA	REF				*	*	*	*	*	3-23	1A5A5C6
P-H	5910-835-2175	CAPACITOR, FIXED, PAPER DIELECTRIC SDBIK01103M (53021)	EA	REF				*	*	*	*	*	3-23	1A5A5C12
P-H	5910-835-2175	CAPACITOR, FIXED, PAPER DIELECTRIC SDBIK01103M (53021)	EA	REF				*	*	*	*	*	3-23	1A5A5C18
P-H	5905-106-9348	RESISTOR; SELECT FROM RESISTOR, FIXED, COMPOSITION RC20GF154K (81349) - OR -	EA	1				*	*	*	*	*		1A5A5R32
P-H	5905-192-0662	RESISTOR, FIXED, COMPOSITION RC20GF184K (81349)	EA	1				*	*	*	*	*		1A5A5R32
P-F	5910-712-6931	CAPACITOR, FIXED, PAPER DIELECTRIC SDBIK06102M (53021)	EA	1	*	*	*	*	*	*	*	*	3-24	1A5A5C15
P-H	5910-702-7381	CAPACITOR, FIXED, PAPER DIELECTRIC 118P10402S3 (56289)	EA	5				*	*	*	*	*	3-23	1A5A5C3
P-H	5910-702-7381	CAPACITOR, FIXED, PAPER DIELECTRIC 118P10402S3 (56289)	EA	REF				*	*	*	*	*	3-23	1A5A5C9
P-H	5910-702-7381	CAPACITOR, FIXED, PAPER DIELECTRIC 118P10402S3 (56289)	EA	REF				*	*	*	*	*	3-23	1A5A5C13
P-H	5910-702-7381	CAPACITOR, FIXED, PAPER DIELECTRIC 118P10402S3 (56289)	EA	REF				*	*	*	*	*	3-23	1A5A5C26
P-H	5910-702-7381	CAPACITOR, FIXED, PAPER DIELECTRIC 118P10402S3 (56289)	EA	REF				*	*	*	*	*	3-23	1A5A5C29
P-H	5910-686-6929	CAPACITOR, FIXED, PAPER DIELECTRIC 118P33302S3 (56289)	EA	3				*	*	*	*	*	3-23	1A5A5C4
P-H	5910-686-6929	CAPACITOR, FIXED, PAPER DIELECTRIC 118P33302S3 (56289)	EA	REF				*	*	*	*	*	3-23	1A5A5C10
P-H	5910-686-6929	CAPACITOR, FIXED, PAPER DIELECTRIC 118P33302S3 (56289)	EA	REF				*	*	*	*	*	3-24	1A5A5C28
P-F	5910-542-7522	CAPACITOR, FIXED, PAPER DIELECTRIC 118P33302S4 (56289)	EA	1	*	*	*	*	*	*	*	*	3-24	1A5A5C17
P-F	5910-542-7522	CAPACITOR, FIXED, PAPER DIELECTRIC 118P33302S4 (56289)	EA	1	*	*	*	*	*	*	*	*	3-24	1A5A5C17
X2-F		BRACKET, CHASSIS 543-1477-002 (13499)	EA	2										
P-F		TERMINAL, STUD 1985 (12615)	EA	REF	*	*	*	*	*	*	*	*		
P-F	5310-584-8129	NUT, SELF-LOCKING, CLINCH 68NG1-40 (72962)	EA	44	*	*	*	*	*	*	*	*		
X2-F		JACK, TIP SKT41WHT (98291)	EA	2									3-23	1A5A5J1
X2-F		JACK, TIP SKT41WHT (98291)	EA	REF									3-23	1A5A5J2
X2-F		BRACKET, TOP 543-1492-003 (13499)	EA	3										
A-F		AMPLIFIER SUBASSEMBLY 543-1480-003 (13499)	EA	2										
P-F	5950-583-0919	TRANSFORMER, INTERMEDIATE FREQUENCY XD71-1 (81815)	EA	1	*	*	*	*	*	*	*	*	3-23	1A5A5T1
P-F	5950-583-0918	TRANSFORMER, INTERMEDIATE FREQUENCY XD72-1 (81815)	EA	1	*	*	*	*	*	*	*	*	3-23	1A5A5T4

SECTION III REPAIR PARTS FOR DIRECT SUPPORT, GENERAL SUPPORT, AND DEPOT MAINTENANCE (CONTINUED)

(1) SR CODE	(2) FEDERAL STOCK NUMBER	(3) DESCRIPTION  REFERENCE NUMBER & MFR. CODE	(4) UNIT OF MEAS	(5) QTY INC IN UNIT	(6) 30-DAY DS MAINT ALLOWANCE			(7) 30-DAY GS MAINT ALLOWANCE			(8) 1 YR ALW PER EQUIP CNTGCTY	(9) DEPOT MAINT ALW PER 100 EQUIP	(10) ILLUSTRATIONS	
					(a) 1-20	(b) 21-50	(c) 51-100	(a) 1-20	(b) 21-50	(c) 51-100			(a) FIG NO.	(b) ITEM NO. OR REFERENCE DESIGNATION
P-F	5950-583-0950	COIL, RADIO FREQUENCY 41-642 (06978)	EA	1	*	*	*	*	*	*	*	*	3-23	1A5A511
P-F	5950-686-6759	COIL, RADIO FREQUENCY X074-1 (81815)	EA	1	*	*	*	*	*	*	*	*	3-23	1A5A512
X1-F		PLATE, CHASSIS 543-1481-004 (13499)	EA	2										
X2-F		RIVET, TUBULAR R3484X3-32CADPLT (99378)	EA	REF										
P-H	5340-951-4572	RETAINER, ELECTRON, TUBE 100-200-16-5 (99378)	EA	REF				*	*	*	*	*		
P-F	5940-782-8942	TERMINAL, FEEDTHRU FTSML (98291)	EA	REF	*	*	*	*	*	*	*	*		
P-F		TERMINAL, STUD 2619A (12615)	EA	REF	*	*	*	*	*	*	*	*		
X1-F		EYELET, METALLIC SE33CADPL (90030)	EA	REF										
X1-F		EYELET, METALLIC SE43HOTTINMED (61957)	EA	REF										
P-F	5310-584-8129	NUT, SELF-LOCKING, CLINCH 68NC1-40 (72962)	EA	REF	*	*	*	*	*	*	*	*		
P-F		BRACKET, TRANSISTOR 543-1512-002 (13499)	EA	9	*	*	*	*	*	*	*	*		
P-F		BRACKET, TRANSISTOR 10-21-120-017 (96214)	EA	9	*	*	*	*	*	*	*	*		
X1-F		BRACKET, MOUNTING 543-1513-002 (13499)	EA	3										
X1-F		SHIELD, ELECTRON 543-1720-002 (13499)	EA	3										
X2-F		BRACKET, MOUNTING 543-1511-003 (13499)	EA	3										
X2-F		CHASSIS, ELECTRICAL 543-1509-005 (13499)	EA	2										
X2-F		PLATE, BASE, AMPLIFIER 543-1482-002 (13499)	EA	1										
X2-F		PLATE, BASE AMPLIFIER 543-1495-004 (13499)	EA	1										
X2-F		PLATE, BASE-CASTING 543-1494-014 (13499)	EA	REF										
P-H		PIN, LOCATING 540-7766-002 (13499)	EA	REF				*	*	*	*	*		
X2-H		FRAME, CHASSIS 543-1483-002 (13499)	EA	1										
X2-H	5310-117-6010	RIVET, SOLID ME20426AD2-3 (96906)	EA	REF										
X2-H		FRAME, CHASSIS 543-1504-004 (13499)	EA	1										
P-H		BRACKET 542-7768-002 (13499)	EA	REF				*	*	*	*	*		
P-H		RETAINER, FILTER 543-1517-002 (13499)	EA	3				*	*	*	*	*		
P-H		SCREW 542-7683-002 (13499)	EA	REF				*	*	*	*	*		
X2-H		PLATE, COVER 542-7683-002 (13499)	EA	REF										

SECTION III REPAIR PARTS FOR DIRECT SUPPORT, GENERAL SUPPORT, AND DEPOT MAINTENANCE (CONTINUED)

(1) SIR CODE	(2) FEDERAL STOCK NUMBER	(3) DESCRIPTION  REFERENCE NUMBER & MFR. CODE	(4) UNIT OF MEAS	(5) QTY INC IN UNIT	(6) 30-DAY DS MAINT ALLOWANCE			(7) 30-DAY GS MAINT ALLOWANCE			(8) 1 YR ALW PER EQUIP CWTGCT	(9) DEPOT MAINT ALW PER 100 EQUIP	(10) ILLUSTRATIONS	
					(a) 1-20	(b) 21-50	(c) 51-100	(a) 1-20	(b) 21-50	(c) 51-100			(a) FIG NO.	(b) ITEM NO., OR REFERENCE DESIGNATION
P-H		WIRE, ELECTRICAL MILW16878TYPE22-95 (81349)	FT	4				*	*	*	*			
P-H		WIRE, ELECTRICAL MILW16878TYPE22-916 (81349)	FT	3				*	*	*	*			
P-F	5910-939-7510	CAPACITOR, FIXED, CERAMIC DIELECTRIC CK15AX223M (81349)	EA	4	*	*	*	*	*	*	*		1A5A5C30	
P-F	5905-195-6806	RESISTOR, FIXED, COMPOSITION RC20GF102K (81349)	EA	1	*	*	*	*	*	*	*	3-24	1A5A5R1	
P-H	5905-279-2658	RESISTOR, FIXED, COMPOSITION RC20GF820K (81349)	EA	1				*	*	*	*	3-23	1A5A5R6	
P-H	5905-279-1756	RESISTOR; SELECT FROM RESISTOR, FIXED, COMPOSITION RC20GF151K (81349)	EA	1				*	*	*	*	3-23	1A5A5R31	
P-F	5905-256-0410	- OR - RESISTOR, FIXED, COMPOSITION RC20GF181K (81349)	EA	1	*	*	*	*	*	*	*	3-23	1A5A5R31	
P-H	5905-256-0409	- OR - RESISTOR, FIXED, COMPOSITION RC20GF221K (81349)	EA	1				*	*	*	*	3-23	1A5A5R31	
P-F	5905-185-6966	- OR - RESISTOR, FIXED, COMPOSITION RC20GF271K (81349)	EA	1	*	*	*	*	*	*	*	3-23	1A5A5R31	
P-F	5905-171-1997	- OR - RESISTOR, FIXED, COMPOSITION RC20GF101J (81349)	EA	1	*	*	*	*	*	*	*	3-23	1A5A5R31	
P-F	5905-11-4742	- OR - RESISTOR, FIXED, COMPOSITION RC20GF391K (81349)	EA	1	*	*	*	*	*	*	*	3-23	1A5A5R31	
P-H	5905-171-2005	- OR - RESISTOR, FIXED, COMPOSITION RC20GF471K (81349)	EA	1				*	*	*	*	3-23	1A5A5R31	
P-H	9505-195-6800	- OR - RESISTOR, FIXED, COMPOSITION RC20GF561K (81349)	EA	1				*	*	*	*	3-23	1A5A5R31	
P-H	5905-256-0387	- OR - RESISTOR, FIXED, COMPOSITION RC20GF681K (81349)	EA	1				*	*	*	*	3-23	1A5A5R31	
A-F		AMPLIFIER 543-0275-005 (13499)	EA	1								3-18	1A5A4	
P-F	5960-264-1028	SHIELD, ELECTRON 141-0223-000 (13499)	EA	1	*	*	*	*	*	*	*		1A5A4E1	
M-H		INSULATION SLEEVING, ELECTRICAL TEFTW20B (81851)	FT	REF										
M-H		INSULATION SLEEVING, ELECTRICAL 152-1736-000 (13499)	FT	REF										
P-F		INSULATION SLEEVING, ELECTRICAL TEFTW22B (81851)	FT	REF	*	*	*	*	*	*	*			
P-F		EYELET, METALLIC SE23HOT11NND (61957)	EA	REF	*	*	*	*	*	*	*			
M-H		INSULATION SLEEVING, ELECTRICAL TEFTW22-3 (81851)	FT	REF										
M-H		INSULATION SLEEVING, ELECTRICAL TEFTW22-1 (81851)	FT	REF										
M-H		INSULATION SLEEVING, ELECTRICAL TEFTW22-0 (81851)	FT	REF										
XI-H		INSULATION SLEEVING, ELECTRICAL TEFTW22-6 (81851)	FT	REF										
M-H		INSULATION SLEEVING, ELECTRICAL TEFTW22-5 (81851)	FT	REF										
M-H		INSULATION SLEEVING, ELECTRICAL TEFTW22-4 (81851)	FT	REF										
F-H	5910-057-5218	CAPACITOR, FIXED, ELECTROLYTIC CL25BJ180TP3 (81349)	EA	1				*	*	*	*	3-26	1A5A4C20	

SECTION III REPAIR PARTS FOR DIRECT SUPPORT, GENERAL SUPPORT, AND DEPOT MAINTENANCE (CONTINUED)

(1) SW CODE	(2) FEDERAL STOCK NUMBER	(3) DESCRIPTION  USABLE ON CODE	(4) UNIT OF MEAS	(5) QTY INC IN UNIT	(6) 30-DAY DS MAINT ALLOWANCE			(7) 30-DAY GS MAINT ALLOWANCE			(8) 1 YR ALW PER EQUIP CNTGTY	(9) DEPOT MAINT ALW PER 100 EQUIP	(10) ILLUSTRATIONS	
					(a)	(b)	(c)	(a)	(b)	(c)			(a)	(b)
					1-20	21-50	51-100	1-20	21-50	51-100			FIG NO.	ITEM NO. OR REFERENCE DESIGNATION
P-F	5910-269-4613	CAPACITOR, FIXED, ELECTROLYTIC CL25BQ04OSP3 (81349)	EA	1	*	*	*	*	*	*	*	*	3-25	1A5A4C16
P-F	5910-992-2070	CAPACITOR, FIXED, ELECTROLYTIC 150D606X0006B2 (56289)	EA	2	*	*	*	*	*	*	*	*	3-26	1A5A4C21
P-F	5910-992-2070	CAPACITOR, FIXED, ELECTROLYTIC 150D606X0006B2 (56289)	EA	REF	*	*	*	*	*	*	*	*	3-26	1A5A4C22
P-H	5910-679-9388	CAPACITOR, FIXED, ELECTROLYTIC 150D224X0035A2 (56289)	EA	1				*	*	*	*	*	3-25	1A5A4C23
P-F	5910-542-7371	CAPACITOR, FIXED, ELECTROLYTIC 150D225X0020A2 (56289)	EA	1	*	*	*	*	*	*	*	*	3-25	1A5A4C24
P-H	5960-230-5226	ELECTRON TUBE 5636 (82219)	EA	1				*	*	*	*	*	3-26	1A5A4V3
P-H	5960-256-9989	ELECTRON TUBE 5699 (82219)	EA	3				*	*	*	*	*		1A5A4V1
P-H	5960-256-9989	ELECTRON TUBE 5699 (82219)	EA	REF				*	*	*	*	*		1A5A4V2
P-H	5960-256-9989	ELECTRON TUBE 5699 (82219)	EA	REF				*	*	*	*	*		1A5A4V4
P-F	5305-054-5647	SCREW, MACHINE MS51957-13 (96906)	EA	REF	*	*	*	*	*	*	*	*		
P-F	5310-595-5421	WASHER, FLAT 310-6320-000 (79807)	EA	REF	*	*	*	*	*	*	*	*		
P-H	5310-622-1724	NUT, SELF-LOCKING, HEXAGON 68-1660-26 (72962)	EA	REF				*	*	*	*	*		
P-H	5310-614-3500	NUT, SELF-LOCKING, HEXAGON 68-166C-40 (72962)	EA	REF				*	*	*	*	*		
P-F	5305-770-2533	SCREW, MACHINE MS51959-13 (96906)	EA	REF	*	*	*	*	*	*	*	*		
P-F	5305-763-7822	SCREW, MACHINE MS51959-14 (96906)	EA	REF	*	*	*	*	*	*	*	*		
P-F	5305-727-8833	SCREW, MACHINE MS51959-3 (96906)	EA	REF	*	*	*	*	*	*	*	*		
P-H	5305-054-5636	SCREW, MACHINE MS51957-2 (96906)	EA	REF				*	*	*	*	*		
P-F	5305-054-5640	SCREW, MACHINE MS51957-6 (96906)	EA	REF	*	*	*	*	*	*	*	*		
P-H	5961-818-4487	TRANSISTOR 2N1150 (07688)	EA	1				*	*	*	*	*	3-26	1A5A4Q1
P-F	5961-553-7012	TRANSISTOR 2N243 (07688)	EA	2	*	*	*	*	*	*	*	*	3-26	1A5A4Q2
P-F	5961-553-7012	TRANSISTOR 2N243 (07688)	EA	REF	*	*	*	*	*	*	*	*	3-26	1A5A4Q3
P-H	5935-057-2690	CONNECTOR, RECEPTACLE, ELECTRICAL DA15P (71468)	EA	1				*	*	*	*	*	3-25	1A5A4P1
P-F	5905-556-7917	RESISTOR, VARIABLE 301011-102 (80294)	EA	1	*	*	*	*	*	*	*	*		1A5A4R33
P-H	5961-866-0476	SEMICONDUCTOR DEVICE, DIODE 1N457 (07688)	EA	2				*	*	*	*	*	3-25	1A5A4CR1
P-H	5961-866-0476	SEMICONDUCTOR DEVICE, DIODE 1N457 (07688)	EA	REF				*	*	*	*	*	3-26	1A5A4CR2
M-H		WIRE, ELECTRICAL 00702-1322 (70567)	FT	REF										
M-H		CABLE, RADIO FREQUENCY RG196AU (80058)	FT	REF										

SECTION III REPAIR PARTS FOR DIRECT SUPPORT, GENERAL SUPPORT, AND DEPOT MAINTENANCE (CONTINUED)

(1) SMR CODE	(2) FEDERAL STOCK NUMBER	(3) DESCRIPTION  REFERENCE NUMBER & MFR. CODE	(4) UNIT OF MEAS	(5) QTY INC IN UNIT	(6) 30-DAY DS MAINT ALLOWANCE			(7) 30-DAY GS MAINT ALLOWANCE			(8) 1 YR ALW PER EQUIP CNTGTY	(9) DEPOT MAINT ALW PER 100 EQUIP	(10) ILLUSTRATIONS	
					(a)	(b)	(c)	(a)	(b)	(c)			(a)	(b)
					1-20	21-50	51-100	1-20	21-50	51-100			FIG NO.	ITEM NO. OR REFERENCE DESIGNATION
M-H		WIRE, ELECTRICAL MILW16878TYPE22-9 (81349)	FT	REF										
M-H		WIRE, ELECTRICAL MILW16878TYPE22-90 (81349)	FT	REF										
M-H		WIRE, ELECTRICAL MILW16878TYPE22-91 (81349)	FT	REF										
P-H		WIRE, ELECTRICAL MILW16878TYPE22-96 (81349)	FT	REF				*	*	*	*	*		
P-H		WIRE, ELECTRICAL MILW16878TYPE22-905 (81349)	FT	REF				*	*	*	*	*		
P-H		WIRE, ELECTRICAL MILW16878TYPE22-906 (81349)	FT	REF				*	*	*	*	*		
P-H		WIRE, ELECTRICAL MILW16878TYPE22-912 (81349)	FT	REF				*	*	*	*	*		
P-H		WIRE, ELECTRICAL MILW16878TYPE22-915 (81349)	FT	REF				*	*	*	*	*		
M-H		WIRE, ELECTRICAL MILW16878TYPE22-0 (81349)	FT	REF										
P-F	5915-583-1964	FILTER, BANDPASS 526-9311-000 (13499)	EA	1	*	*	*	*	*	*	*	*	3-25	1A5A4F11
A-F		SHIELD ASSEMBLY 542-4782-002 (13499)	EA	3									3-26	1A5A4E2
A-F		SHIELD ASSEMBLY 542-4782-002 (13499)	EA	REF									3-26	1A5A4E3
A-F		SHIELD ASSEMBLY 542-4782-002 (13499)	EA	REF									3-26	1A5A4E4
P-F		RETAINER 542-0371-002 (13499)	EA	REF	*	*	*	*	*	*	*	*		
P-F		SHIELD, ELECTRON 542-0375-002 (13499)	EA	REF	*	*	*	*	*	*	*	*		
XL-F		SHIELD-EXTRUDED 542-0378-012 (13499)	EA	REF										
M-H		INSULATION SLEEVING, ELECTRICAL TEPTW16B (81851)	FT	REF										
P-F	5950-055-9626	TRANSFORMER, AUDIO FREQUENCY TS3703 (95088)	EA	1	*	*	*	*	*	*	*	*	3-25	1A5A4T2
P-F	5950-615-0727	TRANSFORMER, AUDIO FREQUENCY 526-6930-000 (13499)	EA	1	*	*	*	*	*	*	*	*	3-26	1A5A4T3
P-H	5905-279-1756	RESISTOR, FIXED, COMPOSITION RC20GF151K (81349)	EA	1	*	*	*	*	*	*	*	*	3-26	1A5A4R3
P-F	5905-171-1997	RESISTOR, FIXED, COMPOSITION RC20GF331K (81349)	EA	1	*	*	*	*	*	*	*	*	3-25	1A5A4R12
P-F	5905-245-0023	RESISTOR, FIXED, COMPOSITION RC20GF682K (81349)	EA	1	*	*	*	*	*	*	*	*	3-26	1A5A4R17
P-F	5905-141-0591	RESISTOR, FIXED, COMPOSITION RC20GF103K (81349)	EA	1	*	*	*	*	*	*	*	*	3-25	1A5A4R27
P-F	5905-106-1282	RESISTOR, FIXED, COMPOSITION RC20GF223K (81349)	EA	2	*	*	*	*	*	*	*	*	3-25	1A5A4R2
P-H	5905-106-1282	RESISTOR, FIXED, COMPOSITION RC20GF223K (81349)	EA	REF				*	*	*	*	*	3-25	1A5A4R5
P-H	5905-171-1986	RESISTOR, FIXED, COMPOSITION RC20GF563J (81349)	EA	1	*	*	*	*	*	*	*	*	3-25	1A5A4R24

TM 11-5820-555-24P  
SECTION III REPAIR PARTS FOR DIRECT SUPPORT, GENERAL SUPPORT, AND DEPOT MAINTENANCE (CONTINUED)

(1) SIR CODE	(2) FEDERAL STOCK NUMBER	(3) DESCRIPTION  REFERENCE NUMBER & MFR. CODE	(4) UNIT OF MEAS	(5) QTY INC IN UNIT	(6) 30-DAY DS MAINT ALLOWANCE			(7) 30-DAY GS MAINT ALLOWANCE			(8) 1 YR ALW PER EQUIP CATG/CY	(9) DEPOT MAINT ALW PER 100 EQUIP	(10) ILLUSTRATIONS		
					USABLE ON CODE	(a) 1-20	(b) 21-50	(c) 51-100	(a) 1-20	(b) 21-50			(c) 51-100	(a) FIG NO.	(b) ITEM NO. OR REFERENCE DESIGNATION
P-F	5905-295-3410	RESISTOR, FIXED, COMPOSITION RC20GF473K (81349)	EA	3	*	*	*	*	*	*	*	*	3-26	1A5A4R9	
P-F	5905-295-3410	RESISTOR, FIXED, COMPOSITION RC20GF473K (81349)	EA	REF	*	*	*	*	*	*	*	*	3-26	1A5A4R13	
P-F	5905-295-3410	RESISTOR, FIXED, COMPOSITION RC20GF473K (81349)	EA	REF	*	*	*	*	*	*	*	*	3-25	1A5A4R30	
P-H	5905-192-3987	RESISTOR, FIXED, COMPOSITION RC20GF104K (81349)	EA	1	*	*	*	*	*	*	*	*	3-25	1A5A4R10	
P-H	5905-106-9348	RESISTOR, FIXED, COMPOSITION RC20GF154K (81349)	EA	1	*	*	*	*	*	*	*	*	3-26	1A5A4R16	
P-H	5905-192-0662	RESISTOR, FIXED, COMPOSITION RC20GF184K (81349)	EA	1	*	*	*	*	*	*	*	*	3-25	1A5A4R15	
P-F	5905-834-2961	RESISTOR, FIXED, COMPOSITION EB4365 (01121)	EA	1	*	*	*	*	*	*	*	*	3-25	1A5A4R25	
P-F	5905-192-0390	RESISTOR, FIXED, COMPOSITION RC20GF105K (81349)	EA	1	*	*	*	*	*	*	*	*	3-25	1A5A4R26	
P-F	5905-114-5388	RESISTOR, FIXED, COMPOSITION RC20GF220K (81349)	EA	2	*	*	*	*	*	*	*	*	3-25	1A5A4R22	
P-F	5905-114-5388	RESISTOR, FIXED, COMPOSITION RC20GF220K (81349)	EA	REF	*	*	*	*	*	*	*	*	3-25	1A5A4R23	
P-F	5905-106-9344	RESISTOR, FIXED, COMPOSITION RC20GF101J (81349)	EA	1	*	*	*	*	*	*	*	*	3-25	1A5A4R21	
P-H	5905-249-4248	RESISTOR, FIXED, COMPOSITION RC20GF333K (81349)	EA	1	*	*	*	*	*	*	*	*	3-26	1A5A4R28	
P-F	5905-141-1311	RESISTOR, FIXED, COMPOSITION RC32GF202J (81349)	EA	1	*	*	*	*	*	*	*	*	3-25	1A5A4R19	
P-F	5905-133-0381	RESISTOR, FIXED, COMPOSITION RC32GF562K (81349)	EA	3	*	*	*	*	*	*	*	*	3-25	1A5A4R4	
P-F	5905-133-0381	RESISTOR, FIXED, COMPOSITION RC32GF562K (81349)	EA	REF	*	*	*	*	*	*	*	*	3-25	1A5A4R7	
P-F	5905-133-0381	RESISTOR, FIXED, COMPOSITION RC32GF562K (81349)	EA	REF	*	*	*	*	*	*	*	*	3-25	1A5A4R29	
P-F	5905-299-2025	RESISTOR, FIXED, COMPOSITION RC32GF153K (81349)	EA	1	*	*	*	*	*	*	*	*	3-26	1A5A4R14	
P-F	5905-253-1231	RESISTOR, FIXED, COMPOSITION RC42GF991K (81349)	EA	1	*	*	*	*	*	*	*	*	3-25	1A5A4R20	
P-F	5910-071-1642	CAPACITOR; SELECT FROM CAPACITOR, FIXED, MICA DIELECTRIC DM15E820G03 (81349)	EA	1	*	*	*	*	*	*	*	*	3-25	1A5A4C8	
P-F	5910-811-5919	- OR - CAPACITOR, FIXED, MICA DIELECTRIC DM15E860G0500WV4CR (72136)	EA	1	*	*	*	*	*	*	*	*	3-25	1A5A4C8	
P-F	5910-061-7453	- OR - CAPACITOR, FIXED, MICA DIELECTRIC DM15E890G0500WV4CR (72136)	EA	1	*	*	*	*	*	*	*	*	3-25	1A5A4C8	
P-F	5910-781-7929	- OR - CAPACITOR, FIXED, MICA DIELECTRIC DM15F910G03 (81349)	EA	1	*	*	*	*	*	*	*	*	3-25	1A5A4C8	
P-F	5910-990-5413	- OR - CAPACITOR, FIXED, MICA DIELECTRIC DM15E960F0500WV4CR (72136)	EA	1	*	*	*	*	*	*	*	*	3-25	1A5A4C8	
P-F	5910-044-4963	- OR - CAPACITOR, FIXED, MICA DIELECTRIC DM15E101F0300WV4CR (72136)	EA	1	*	*	*	*	*	*	*	*	3-25	1A5A4C8	
P-F	5910-810-8264	- OR - CAPACITOR, FIXED, MICA DIELECTRIC DM15E1050F0500WV4CR (72136)	EA	1	*	*	*	*	*	*	*	*	3-25	1A5A4C8	
P-F	5910-854-8543	- OR - CAPACITOR, FIXED, MICA DIELECTRIC DM15E1070F0300WV4CR (72136)	EA	1	*	*	*	*	*	*	*	*	3-25	1A5A4C8	



SECTION III REPAIR PARTS FOR DIRECT SUPPORT, GENERAL SUPPORT, AND DEPOT MAINTENANCE (CONTINUED)

(1) SR CODE	(2) FEDERAL STOCK NUMBER	(3) DESCRIPTION  REFERENCE NUMBER & MFR. CODE	(4) UNIT OF MEAS	(5) QTY INC IN UNIT	(6) 30-DAY DS MAINT ALLOWANCE			(7) 30-DAY GS MAINT ALLOWANCE			(8) 1 YR ALW PER EQUIP CNTCT	(9) DEPOT MAINT ALW PER 100 EQUIP	(10) ILLUSTRATIONS	
					(a) 1-20	(b) 21-50	(c) 51-100	(a) 1-20	(b) 21-50	(c) 51-100			(a) FIG NO.	(b) ITEM NO. OR REFERENCE DESIGNATION
P-F	5910-027-9964	CAPACITOR, FIXED, MICA DIELECTRIC IML5E110FD300NV4CR (72136) - OR -	EA	1	*	*	*	*	*	*	*	*	3-25	1A5A4C8
P-F	5910-080-3688	CAPACITOR, FIXED, MICA DIELECTRIC IML5E114G00500NV4CR (72136) - OR -	EA	1	*	*	*	*	*	*	*	*	3-25	1A5A4C8
P-F	5910-954-5504	CAPACITOR, FIXED, MICA DIELECTRIC CM05F121G03 (81349)	EA	1	*	*	*	*	*	*	*	*	3-25	1A5A4C8
P-F	5910-681-7140	CAPACITOR, FIXED, MICA DIELECTRIC 22H5T18EG (14655)	EA	1	*	*	*	*	*	*	*	*	3-25	1A5A4C5
P-F	5910-683-7478	CAPACITOR, FIXED, MICA DIELECTRIC 22H5T13EG (14655)	EA	1	*	*	*	*	*	*	*	*	3-26	1A5A4C27
P-F	5910-984-5253	CAPACITOR, FIXED, MICA DIELECTRIC 22H5T13EG (14655)	EA	1	*	*	*	*	*	*	*	*	3-26	1A5A4C25
P-F	5910-060-9619	CAPACITOR, FIXED, MICA DIELECTRIC 22H5T91EG (14655)	EA	2	*	*	*	*	*	*	*	*	3-26	1A5A4C11
P-F	5910-060-9619	CAPACITOR, FIXED, MICA DIELECTRIC 22H5T91EG (14655)	EA	REF	*	*	*	*	*	*	*	*	3-26	1A5A4C14
P-F	5910-800-0357	CAPACITOR, FIXED, PAPER DIELECTRIC 186P15391S3 (56289)	EA	2	*	*	*	*	*	*	*	*	3-25	1A5A4C2
P-F	5910-800-0357	CAPACITOR, FIXED, PAPER DIELECTRIC 186P15391S3 (56289)	EA	REF	*	*	*	*	*	*	*	*	3-25	1A5A4C7
P-H	5910-835-2175	CAPACITOR, FIXED, PAPER DIELECTRIC SDB1K01103M (53021)	EA	4	*	*	*	*	*	*	*	*	3-25	1A5A4C1
P-H	5910-835-1275	CAPACITOR, FIXED, PAPER DIELECTRIC SDB1K01103M (53021)	EA	REF	*	*	*	*	*	*	*	*	3-25	1A5A4C6
P-H	5910-835-1275	CAPACITOR, FIXED, PAPER DIELECTRIC SDB1K01103M (53021)	EA	REF	*	*	*	*	*	*	*	*	3-25	1A5A4C12
P-H	5910-835-1275	CAPACITOR, FIXED, PAPER DIELECTRIC SDB1K01103M (53021)	EA	REF	*	*	*	*	*	*	*	*	3-25	1A5A4C18
P-H	5905-106-9348	RESISTOR, SELECT FRGM RESISTOR, FIXED, COMPOSITION RC20GF154K (81349) - OR -	EA	1	*	*	*	*	*	*	*	*		1A5A4R32
P-H	5905-292-0662	RESISTOR, FIXED, COMPOSITION RC20GF184K (81349)	EA	1	*	*	*	*	*	*	*	*		1A5A4R32
P-F	5910-712-6931	CAPACITOR, FIXED, PAPER DIELECTRIC SDB1K06102M (53021)	EA	1	*	*	*	*	*	*	*	*	3-26	1A5A4C15
P-H	5910-702-7381	CAPACITOR, FIXED, PAPER DIELECTRIC 118P10402S3 (56289)	EA	5	*	*	*	*	*	*	*	*	3-25	1A5A4C3
P-H	5910-702-7381	CAPACITOR, FIXED, PAPER DIELECTRIC 118P10402S3 (56289)	EA	REF	*	*	*	*	*	*	*	*	3-25	1A5A4C9
P-H	5910-702-7381	CAPACITOR, FIXED, PAPER DIELECTRIC 118P10402S3 (56289)	EA	REF	*	*	*	*	*	*	*	*	3-25	1A5A4C13
P-H	5910-702-7381	CAPACITOR, FIXED, PAPER DIELECTRIC 118P10402S3 (56289)	EA	REF	*	*	*	*	*	*	*	*	3-25	1A5A4C26
P-H	5910-702-7381	CAPACITOR, FIXED, PAPER DIELECTRIC 118P10402S3 (56289)	EA	REF	*	*	*	*	*	*	*	*	3-25	1A5A4C29
P-H	5910-686-6929	CAPACITOR, FIXED, PAPER DIELECTRIC 118P33302S3 (56289)	EA	3	*	*	*	*	*	*	*	*	3-25	1A5A4C4
P-H	5910-686-6929	CAPACITOR, FIXED, PAPER DIELECTRIC 118P33302S3 (56289)	EA	REF	*	*	*	*	*	*	*	*	3-25	1A5A4C10
P-H	5910-686-6929	CAPACITOR, FIXED, PAPER DIELECTRIC 118P33302S3 (56289)	EA	REF	*	*	*	*	*	*	*	*	3-26	1A5A4C28
P-F	5910-542-7522	CAPACITOR, FIXED, PAPER DIELECTRIC 118P33302S4 (56289)	EA	1	*	*	*	*	*	*	*	*	3-26	1A5A4C17
P-F	5910-542-7522	CAPACITOR, FIXED, PAPER DIELECTRIC 118P33302S4 (56289)	EA	REF	*	*	*	*	*	*	*	*	3-26	1A5A4C17

SECTION III REPAIR PARTS FOR DIRECT SUPPORT, GENERAL SUPPORT, AND DEPOT MAINTENANCE (CONTINUED)

(1) SIR CODE	(2) FEDERAL STOCK NUMBER	(3) DESCRIPTION  REFERENCE NUMBER & MFR. CODE	(4) UNIT OF MEAS	(5) QTY INC IN UNIT	(6) 30-DAY DS MAINT ALLOWANCE			(7) 30-DAY GS MAINT ALLOWANCE			(b) 1 YR ALW PER EQUIP ENTGTY	(9) DEPOT MAINT ALW PER 100 EQUIP	(10) ILLUSTRATIONS	
					(a) 1-20	(b) 21-50	(c) 51-100	(a) 1-20	(b) 21-50	(c) 51-100			(a) FIG NO.	(b) ITEM NO. OR REFERENCE DESIGNATION
X2-F		BRACKET, CHASSIS 543-1477-002 (13499)	EA	REF										
P-F		TERMINAL, STUD 1985 (12615)	EA	REF	*	*	*	*	*	*	*			
P-F	5310-584-8129	NUT, SELF-LOCKING, CLINCH 68NC1-40 (72962)	EA	REF	*	*	*	*	*	*	*			
X2-F		JACK, TIP SKT41WHT (98291)	EA	2								3-25	1A5A4J1	
X2-F		JACK, TIP SKT41WHT (98291)	EA	REF								3-25	1A5A4J2	
X2-F		BRACKET, TOP 543-1492-003 (13499)	EA	REF										
X2-F		PLATE, BASE 543-1478-002 (13499)	EA	1										
P-H		PIN, LOCATING 540-7766-002 (13499)	EA	REF				*	*	*	*			
X2-F		PLATE, BASE 543-1494-004 (13499)	EA	1										
X2-F		PLATE, BASE CASTING MS20426AD2-3 (96906)	EA	REF										
X2-F		FRAME, CHASSIS 543-1479-002 (13499)	EA	1										
X2-F	5320-117-6010	RIVET, SOLID MS20426AD2-3 (96906)	EA	REF										
X2-F		FRAME, CHASSIS 543-1505-004 (13499)	EA	1										
P-H		BRACKET, RETAINING 542-7768-002 (13499)	EA	REF				*	*	*	*			
A-F		AMPLIFIER SUBASSEMBLY 543-1400-003 (13499)	EA	REF										
P-F	5950-583-0919	TRANSFORMER, INTERMEDIATE FREQUENCY X071-1 (81815)	EA	1	*	*	*	*	*	*	*	3-25	1A5A4T1	
P-F	5950-583-0918	TRANSFORMER, INTERMEDIATE FREQUENCY X072-1 (81815)	EA	1	*	*	*	*	*	*	*	3-25	1A5A4T4	
P-F	5950-583-0950	COIL, RADIO FREQUENCY 41-642 (06978)	EA	1	*	*	*	*	*	*	*	3-25	1A5A4L1	
P-F	5950-686-6759	COIL, RADIO FREQUENCY X074-1 (81815)	EA	1	*	*	*	*	*	*	*	3-25	1A5A4L2	
X1-F		PLATE, CHASSIS 543-1481-004 (13499)	EA	REF										
X2-F		RIVET, TUBULAR R3484X3-32CADPL (12014)	EA	REF										
P-H	5340-951-4572	RETAINER, ELECTRON TUBE 100-200-16-5 (99378)	EA	REF				*	*	*	*			
P-F	5940-782-8942	TERMINAL, FEEDTHRU FTSM1 (98291)	EA	REF	*	*	*	*	*	*	*			
P-F		TERMINAL, STUD 2619A (12615)	EA	REF	*	*	*	*	*	*	*			
X1-F		EYELET, METALLIC SE33CADPL (900X)	EA	REF										
X1-F		EYELET, METALLIC SE43HOTTINNED (61957)	EA	REF										
P-F	5310-584-8129	NUT, SELF-LOCKING, CLINCH 68NC1-40 (72962)	EA	REF	*	*	*	*	*	*	*			

SECTION III REPAIR PARTS FOR DIRECT SUPPORT, GENERAL SUPPORT, AND DEPOT MAINTENANCE (CONTINUED)

(1) SQR CODE	(2) FEDERAL STOCK NUMBER	(3) DESCRIPTION  REFERENCE NUMBER & MFR. CODE	(4) UNIT OF MEAS	(5) QTY INC IN UNIT	(6) 30-DAY DS MAINT ALLOWANCE			(7) 30-DAY GS MAINT ALLOWANCE			(8) 1 YR ALY PER EQUIP ENTGTY	(9) DEPOT MAINT ALY PER 100 EQUIP	(10) ILLUSTRATIONS	
					(a) 1-20	(b) 21-50	(c) 51-100	(a) 1-20	(b) 21-50	(c) 51-100			(a) FIG NO.	(b) ITEM NO. OR REFERENCE DESIGNATION
P-F		BRACKET, TRANSISTOR 543-1512-002 (13499)	EA	REF	*	*	*	*	*	*	*			
P-F		BRACKET, TRANSISTOR 10-21-120-017 (96214)	EA	REF	*	*	*	*	*	*	*			
X1-F		BRACKET, MOUNTING 543-1513-002 (13499)	EA	REF										
X1-F		SHIELD, ELECTRON 543-1520-002 (13499)	EA	REF										
X2-F		BRACKET, MOUNTING 543-1511-003 (13499)	EA	REF										
X2-F		CHASSIS, ELECTRICAL 543-1509-005 (13499)	EA	REF										
P-H		RETAINER, FILTER 543-1517-002 (13499)	EA	REF				*	*	*	*	*		
P-H		SCREW 542-7683-002 (13499)	EA	REF				*	*	*	*	*		
X2-F		PLATE, COVER 542-7696-003 (13499)	EA	REF										
P-H		WIRE, ELECTRICAL MILW16878TYPE22-95 (81349)	FT	REF				*	*	*	*	*		
P-H		WIRE, ELECTRICAL MILW16878TYPE22-916 (81349)	FT	REF				*	*	*	*	*		
P-F	5910-939-7510	CAPACITOR, FIXED, CERAMIC DIELECTRIC CK15AX223M (81349)	EA	1	*	*	*	*	*	*	*	*		1A5A4C30
P-F	5905-195-6806	RESISTOR, FIXED, COMPOSITION RC20GF102K (81349)	EA	1	*	*	*	*	*	*	*	*	3-26	1A5A4R1
P-H	5905-279-2658	RESISTOR, FIXED, COMPOSITION RC20GF820K (81349)	EA	1				*	*	*	*	*	3-25	1A5A4R6
P-H	5905-279-1756	RESISTOR; SELECT FROM RESISTOR, FIXED, COMPOSITION RC20GF151K (81349)	EA	1				*	*	*	*	*	3-25	1A5A4R31
P-F	5905-256-0410	- OR - RESISTOR, FIXED, COMPOSITION RC20GF181K (81349)	EA	1	*	*	*	*	*	*	*	*	3-25	1A5A4R31
P-H	5905-256-0409	- OR - RESISTOR, FIXED, COMPOSITION RC20GF221K (81349)	EA	1				*	*	*	*	*	3-25	1A5A4R31
P-F	5905-185-6966	- OR - RESISTOR, FIXED, COMPOSITION RC20GF271K (81349)	EA	1	*	*	*	*	*	*	*	*	3-25	1A5A4R31
P-F	5905-171-1997	- OR - RESISTOR, FIXED, COMPOSITION RC20GF311K (81349)	EA	1	*	*	*	*	*	*	*	*	3-25	1A5A4R31
P-F	5905-111-4742	- OR - RESISTOR, FIXED, COMPOSITION RC20GF391K (81349)	EA	1	*	*	*	*	*	*	*	*	3-25	1A5A4R31
P-H	5905-171-2005	- OR - RESISTOR, FIXED, COMPOSITION RC20GF471K (81349)	EA	1				*	*	*	*	*	3-25	1A5A4R31
P-H	5905-942-9326	- OR - RESISTOR, FIXED, COMPOSITION RC20GF561K (81349)	EA	1				*	*	*	*	*	3-25	1A5A4R31
P-H	5905-256-0387	- OR - RESISTOR, FIXED, COMPOSITION RC20GF681K (81349)	EA	1				*	*	*	*	*	3-25	1A5A4R31
A-F		CARRIER, GENERATOR 543-1500-004 (13499)	EA	1									3-18	1A5A2
P-F	5340-200-2637	RING, RETAINING MS16624-12 (96906)	EA	REF	*	*	*	*	*	*	*	*		
P-F	5305-770-2533	SCREW, MACHINE MS1959-13 (96906)	EA	REF	*	*	*	*	*	*	*	*		
P-F	5305-764-2966	SCREW, MACHINE CM20E202G500NV (72136)	EA	REF	*	*	*	*	*	*	*	*		

SECTION III REPAIR PARTS FOR DIRECT SUPPORT, GENERAL SUPPORT, AND DEPOT MAINTENANCE (CONTINUED)

(1) SIR CODE	(2) FEDERAL STOCK NUMBER	(3) DESCRIPTION  REFERENCE NUMBER & MFR. CODE	(4) UNIT OF MEAS	(5) QTY INC IN UNIT	(6) 30-DAY DS MAINT ALLOWANCE			(7) 30-DAY GS MAINT ALLOWANCE			(8) 1 YR ALW PER EQUIP CWTQTY	(9) DEPOT MAINT ALW PER 100 EQUIP	(10) ILLUSTRATIONS	
					(a) 1-20	(b) 21-50	(c) 51-100	(a) 1-20	(b) 21-50	(c) 51-100			(a) FIG NO.	(b) ITEM NO. OR REFERENCE DESIGNATION
P-F	5305-727-8833	SCREW MACHINE MS51959-3 (96906)	EA	REF	*	*	*	*	*	*	*			
P-F	5305-054-5646	SCREW, MACHINE MS51957-12 (96906)	EA	REF	*	*	*	*	*	*	*			
A-F		SHIELD, ASSEMBLY 542-4782-002 (13499)	EA	3								3-27	1A5A2E1	
A-F		SHIELD, ASSEMBLY 542-4782-002 (13499)	EA	REF								3-27	1A5A2E2	
A-F		SHIELD, ASSEMBLY 542-4782-002 (13499)	EA	REF								3-28	1A5A2E3	
P-F		RETAINER, ELECTRON TUBE 542-0371-002 (13499)	EA	REF	*	*	*	*	*	*	*			
P-F		SHIELD, ELECTRON 542-0375-002 (13499)	EA	REF	*	*	*	*	*	*	*			
XI-F		SHIELD, EXTRUDED 542-0378-012 (13499)	EA	REF										
P-F		PIN, SHOULDER 543-1833-002 (13499)	EA	REF	*	*	*	*	*	*	*			
P-F		WASHER, SPRING 543-1834-002 (13499)	EA	REF	*	*	*	*	*	*	*			
XI-F		PLATE 543-1835-002 (13499)	EA	REF										
X2-F		PLATE, CHASSIS 543-1836-002 (13499)	EA	1										
P-F		POST, MOUNTING 543-1839-002 (13499)	EA	1	*	*	*	*	*	*	*			
P-F		NUT, PLAIN, CLINCH 543-1829-002 (13499)	EA	REF	*	*	*	*	*	*	*			
P-F		NUT, PLAIN, CLINCH 543-1830-002 (13499)	EA	REF	*	*	*	*	*	*	*			
X2-F		PLATE, CHASSIS 543-1846-003 (13499)	EA	1										
X2-F		FRAME, CHASSIS 543-1840-002 (13499)	EA	1										
X2-F		FRAME, CHASSIS 543-1858-004 (13499)	EA	1										
P-H		BRACKET, RETAINING 542-7768-002 (13499)	EA	REF				*	*	*	*			
X2-F	5320-117-6010	RIVET, SOLID MS20426AD2-3 (96906)	EA	REF										
P-F		PROD, TEST, PRESSED 543-1838-002 (13499)	EA	REF	*	*	*	*	*	*	*			
X2-F		HOLDER, TEST PROD 543-1832-002 (13499)	EA	REF										
X2-F		JACK, TIP SKT41WHT (98291)	EA	3								3-27	1A5A2J1	
X2-F		JACK, TIP SKT41WHT (98291)	EA	REF								3-27	1A5A2J2	
X2-F		JACK, TIP SKT41WHT (98291)	EA	REF								3-28	1A5A2J3	
P-H		SCREW 542-7683-002 (13499)	EA	REF				*	*	*	*			
P-F		NUT, PLAIN, HEXAGON P313-0156-000 (77250)	EA	REF	*	*	*	*	*	*	*			

SECTION III REPAIR PARTS FOR DIRECT SUPPORT, GENERAL SUPPORT, AND DEPOT MAINTENANCE (CONTINUED)

(1) S&P CODE	(2) FEDERAL STOCK NUMBER	(3) DESCRIPTION  REFERENCE NUMBER & MFR. CODE	(4) UNIT OF MEAS	(5) QTY INC IN UNIT	(6) 30-DAY DS MAINT ALLOWANCE			(7) 30-DAY GS MAINT ALLOWANCE			(8) 1 YR ALW PER EQUIP CNTGCT	(9) DEPOT MAINT ALW PER 100 EQUIP	(10) ILLUSTRATIONS	
					(a) (-20)	(b) 21-50	(c) 51-100	(a) (-20)	(b) 21-50	(c) 51-100			(a) FIG NO.	(b) ITEM NO. OR REFERENCE DESIGNATION
X2-F		PLATE, BASE 543-1837-002 (13499)	EA	1										
X2-F		PLATE, BASE AMPLIFIER 543-1842-003 (13499)	EA	1										
X2-F		PLATE, CASTING 543-1494-014 (13499)	EA	REF										
P-H		PIN, LOCATING 541-6556-002 (13499)	EA	REF				*	*	*	*	*		
A-F		AMPLIFIER SUBASSEMBLY 543-1848-003 (13499)	EA	1										1A5A2Z1
P-H	5999-790-0587	PRINTED, CIRCUIT BOARD 543-1844-003 (13499)	EA	1				*	*	*	*	*	3-28	1A5A2TB1
P-H		TERMINAL, STUD 542-4085-002 (13499)	EA	REF				*	*	*	*	*		
X2-H		EYELET, METALLIC AL444HOT TINNED (57771)	EA	REF										
X1-H		EYELET, METALLIC 542-0810-003 (13499)	EA	REF										
X1-H		PRINTED CIRCUIT BOARD 542-4130-003 (13499)	EA	1										
P-F	5910-683-8008	CAPACITOR, VARIABLE, GLASS DIELECTRIC VC42G (73899)	EA	1	*	*	*	*	*	*	*	*	3-27	1A5A2C5
P-H	5910-581-9801	CAPACITOR, FIXED, MICA DIELECTRIC 22H5T15E3 (14655)	EA	2				*	*	*	*	*	3-27	1A5A2C11
P-H	5910-581-9801	CAPACITOR, FIXED, MICA DIELECTRIC 22H5T15E3 (14655)	EA	REF				*	*	*	*	*	3-27	1A5A2C12
P-H	5910-060-6919	CAPACITOR, FIXED, MICA DIELECTRIC 22H5T15EJ (14655)	EA	1				*	*	*	*	*	3-27	1A5A2C1
P-F	5910-655-0137	CAPACITOR, FIXED, PAPER DIELECTRIC SDB1K01473M (53021)	EA	2	*	*	*	*	*	*	*	*	3-27	1A5A2C7
P-H	5910-617-2346	CAPACITOR, FIXED, PAPER DIELECTRIC SDB1K02333M (53021)	EA	2				*	*	*	*	*	3-27	1A5A2C2
P-H	5910-617-3246	CAPACITOR, FIXED, PAPER DIELECTRIC SDB1K02333M (53021)	EA	REF				*	*	*	*	*	3-27	1A5A2C14
P-F	5910-679-9472	CAPACITOR, FIXED, MICA DIELECTRIC 633-013-352G (72982)	EA	1	*	*	*	*	*	*	*	*	3-27	1A5A2C4
P-H	5905-257-2631	RESISTOR, FIXED, COMPOSITION RC20GF821K (81349)	EA	1				*	*	*	*	*	3-27	1A5A2R5
P-F	5910-045-5315	CAPACITOR, FIXED, CERAMIC DIELECTRIC CCL6AX473M (81349)	EA	1	*	*	*	*	*	*	*	*	3-27	1A5A2C18
P-F	5905-192-0390	RESISTOR, FIXED, COMPOSITION RC20GF105K (81349)	EA	1	*	*	*	*	*	*	*	*	3-27	1A5A2R1
P-F	5905-104-8339	RESISTOR, FIXED, COMPOSITION RC20GF824K (81349)	EA	1	*	*	*	*	*	*	*	*	3-27	1A5A2R3
P-H	5950-683-3461	COIL, RADIO FREQUENCY 18-184 (09250)	EA	1				*	*	*	*	*	3-27	1A5A2L3
P-H	5950-683-3437	COIL, RADIO FREQUENCY 18-180 (09250)	EA	1				*	*	*	*	*	3-27	1A5A2L5
P-F	5950-676-7095	COIL, RADIO FREQUENCY S63657 (82068)	EA	1	*	*	*	*	*	*	*	*	3-27	1A5A2L1
P-F	5960-230-5241	ELECTRON TUBE 5840 (94151)	EA	2	*	*	*	*	*	*	*	*	3-27	1A5A2V1
P-H	5960-261-8679	ELECTRON TUBE 6021 (49956)	EA	1				*	*	*	*	*	3-27	1A5A2V2

TM 11-5820-555-24P  
SECTION III REPAIR PARTS FOR DIRECT SUPPORT, GENERAL SUPPORT, AND DEPOT MAINTENANCE (CONTINUED)

(1) SMR CODE	(2) FEDERAL STOCK NUMBER	(3) DESCRIPTION  REFERENCE NUMBER & MFR. CODE	(4) UNIT OF MEAS	(5) QTY INC IN UNIT	(6) 30-DAY DS MAINT ALLOWANCE			(7) 30-DAY GS MAINT ALLOWANCE			(8) 1 YR ALW PER EQUIP CHNGY	(9) DEPOT MAINT ALW PER 100 EQUIP	(10) ILLUSTRATIONS	
					(a)	(b)	(c)	(a)	(b)	(c)			(a) FIG NO.	(b) ITEM NO. OR REFERENCE DESIGNATION
					1-20	21-50	51-100	1-20	21-50	51-100				
M-H		WIRE, ELECTRICAL 00702-1322 (70567)	FT	REF										
M-H		INSULATION SLEEVING, ELECTRICAL TEFTW22-3 (81851)	FT	REF										
M-H		INSULATION SLEEVING, ELECTRICAL TEFTW22-1 (81851)	FT	REF										
M-H		INSULATION SLEEVING, ELECTRICAL TEFTW22-0 (81851)	FT	REF										
XI-H		INSULATION SLEEVING, ELECTRICAL TEFTW22-6 (81851)	FT	REF										
M-H		INSULATION SLEEVING, ELECTRICAL TEFTW22-5 (81851)	FT	REF										
M-H		INSULATION SLEEVING, ELECTRICAL TEFTW22-4 (81851)	FT	REF										
P-F	5950-615-0606	REACTOR, TOROID 543-1847-003 (13499)	EA	1	*	*	*	*	*	*	*	3-27	1A5A2L4	
XI-F		INSERT, SCREW 542-5441-002 (13499)	EA	1										
XI-H		FORM, COIL 204F250-30 (02114)	EA	1										
M-H		WIRE, ELECTRICAL 00702-1322 (70567)	FT	REF										
M-H		WIRE, ELECTRICAL ANALAC32AWG (81554)	FT	REF										
P-F	5305-054-5646	SCREW, MACHINE MS51957-12 (96906)	EA	REF	*	*	*	*	*	*	*			
P-H	5905-106-1282	RESISTOR, FIXED, COMPOSITION RC20GF223K (81349)	EA	1								3-27	1A5A2R4	
A-F		AMPLIFIER SUBASSEMBLY 543-1849-003 (13499)	EA	1									1A5A2Z2	
P-H	5999-790-0586	PRINTED CIRCUIT BOARD 543-1845-003 (13499)	EA	1			*	*	*	*	*	3-27	1A5A2TB2	
P-H		TERMINAL, STUD 542-4085-002 (13499)	EA	REF			*	*	*	*	*			
XI-H		EYELET, METALLIC A25HOTTINNED (57771)	EA	REF										
XI-H		EYELET, METALLIC 542-0810-003 (13499)	EA	REF										
XI-H		PRINTED CIRCUIT BOARD 542-4131-003 (13499)	EA	1										
P-H	5910-060-9619	CAPACITOR, FIXED, MICA DIELECTRIC 22H5T51EJ (14655)	EA	1			*	*	*	*	*	3-28	1A5A2C9	
P-H	5910-617-3246	CAPACITOR, FIXED, PAPER DIELECTRIC SDB1K02333M (53021)	EA	3			*	*	*	*	*	3-28	1A5A2C13	
P-H	5910-617-3246	CAPACITOR, FIXED, PAPER DIELECTRIC SDB1K02333M (53021)	EA	REF			*	*	*	*	*	3-28	1A5A2C16	
P-H	5910-617-3246	CAPACITOR, FIXED, PAPER DIELECTRIC SDB1K02333M (53021)	EA	REF			*	*	*	*	*	3-28	1A5A2C17	
P-F	5910-655-0137	CAPACITOR, FIXED, PAPER DIELECTRIC SDB1K0473M (53021)	EA	REF	*	*	*	*	*	*	*	3-28	1A5A2C6	
P-F	5910-990-4111	CAPACITOR, FIXED, ELECTROLYTIC CL21CK020TP3 (81349)	EA	1	*	*	*	*	*	*	*	3-28	1A5A2C10	
P-F	5910-663-5780	CAPACITOR, FIXED, MICA DIELECTRIC 22H5Q39DJ (14655)	EA	1	*	*	*	*	*	*	*	3-28	1A5A2C8	

ABSL

SECTION III REPAIR PARTS FOR DIRECT SUPPORT, GENERAL SUPPORT, AND DEPOT MAINTENANCE (CONTINUED)

(1) SRR CODE	(2) FEDERAL STOCK NUMBER	(3) DESCRIPTION  REFERENCE NUMBER & MFR. CODE	(4) UNIT OF MEAS	(5) QTY INC IN UNIT	(6) 30-DAY GS MAINT ALLOWANCE			(7) 30-DAY GS MAINT ALLOWANCE			(8) 1 YR ALW PER EQUIP CMTGCT	(9) DEPOT MAINT ALW PER 100 EQUIP	(10) ILLUSTRATIONS	
					(a) 1-20	(b) 21-50	(c) 51-100	(a) 1-20	(b) 21-50	(c) 51-100			(a) FIG NO.	(b) ITEM NO. OR REFERENCE DESIGNATION
P-H	5905-195-6453	RESISTOR, FIXED, COMPOSITION RC20GF562K (81349)	EA	1	*	*	*	*	*	*	*	*	3-28	1A5A2R11
P-F	5901-106-1273	RESISTOR, FIXED, COMPOSITION RC20GF153J (81349)	EA	2	*	*	*	*	*	*	*	*	3-28	1A5A2R10
P-F	5905-106-1273	RESISTOR, FIXED, COMPOSITION RC20GF153J (81349)	EA	REF	*	*	*	*	*	*	*	*	3-28	1A5A2R7
P-H	5905-171-2002	RESISTOR, FIXED, COMPOSITION RC20GF470K (81349)	EA	1	*	*	*	*	*	*	*	*	3-28	1A5A2R8
P-H	5961-866-0476	SEMICONDUCTOR DEVICE, DIODE 1N457 (07698)	EA	1	*	*	*	*	*	*	*	*	3-28	1A5A2CR1
P-F	5950-683-3454	COIL, RADIO FREQUENCY 18-273 (09250)	EA	1	*	*	*	*	*	*	*	*	3-28	1A5A2L2
P-H	5950-683-3437	COIL, RADIO FREQUENCY 18-180 (09250)	EA	1	*	*	*	*	*	*	*	*	3-28	1A5A2L6
M-H		CABLE, RADIO FREQUENCY RG196AU (80058)	FT	REF										
M-H		INSULATION SLEEVING, ELECTRICAL TEFTW22-3 (81851)	FT	REF										
M-H		INSULATION SLEEVING, ELECTRICAL TEFTW22-1 (81851)	FT	REF										
M-H		INSULATION SLEEVING, ELECTRICAL TEFTW22-0 (81851)	FT	REF										
X1-H		INSULATION SLEEVING, ELECTRICAL TEFTW22-6 (81851)	FT	REF										
M-H		INSULATION SLEEVING, ELECTRICAL TEFTW22-5 (81851)	FT	REF										
M-H		INSULATION SLEEVING, ELECTRICAL TEFTW22-4 (81851)	FT	REF										
P-F	5960-230-5241	ELECTRON TUBE 5840 (94151)	EA	REF	*	*	*	*	*	*	*	*	3-28	1A5A2V3
M-H		WIRE, ELECTRICAL MILM16878TYPE22-9 (81349)	FT	REF										
P-F	5910-717-0169	CAPACITOR, FIXED, MICA DIELECTRIC 22H5T1EJ (14655)	EA	1	*	*	*	*	*	*	*	*	3-28	1A5A2C15
P-H	5905-171-1986	RESISTOR, FIXED, COMPOSITION RC20GF563J (81349)	EA	1	*	*	*	*	*	*	*	*	3-28	1A5A2R12
P-H		WIRE, ELECTRICAL MILM16878TYPE22-96 (81349)	FT	REF										
M-H		WIRE, ELECTRICAL WTE22A (90484)	FT	REF										
P-H	5310-857-5548	NUT, SELF-LOCKING, HEXAGON MS20144D04 (96906)	EA	REF										
P-F	5905-141-0591	RESISTOR, SELECT FROM RESISTOR, FIXED, COMPOSITION RC20GF103J (81349)	EA	1	*	*	*	*	*	*	*	*	3-27	1A5A2R2
P-F	5905-114-5359	- OR - RESISTOR, FIXED, COMPOSITION RC20GF113J (81349)	EA	1	*	*	*	*	*	*	*	*	3-27	1A5A2R2
P-F	5905-141-1165	- OR - RESISTOR, FIXED, COMPOSITION RC20GF123J (81349)	EA	1	*	*	*	*	*	*	*	*	3-27	1A5A2R2
P-F	5905-279-2669	- OR - RESISTOR, FIXED, COMPOSITION RC20GF133J (81349)	EA	1	*	*	*	*	*	*	*	*	3-27	1A5A2R2
P-F	5905-106-1273	- OR - RESISTOR, FIXED, COMPOSITION RC20GF153J (81349)	EA	1	*	*	*	*	*	*	*	*	3-27	1A5A2R2
P-F	5905-110-0943	- OR - RESISTOR, FIXED, COMPOSITION RC20GF163J (81349)	EA	1	*	*	*	*	*	*	*	*	3-27	1A5A2R2

SECTION III REPAIR PARTS FOR DIRECT SUPPORT, GENERAL SUPPORT, AND DEPOT MAINTENANCE (CONTINUED)

(1) SR CODE	(2) FEDERAL STOCK NUMBER	(3) DESCRIPTION  REFERENCE NUMBER & MFR. CODE	(4) UNIT OF MEAS	(5) QTY INC IN UNIT	(6) 30-DAY DS MAINT ALLOWANCE			(7) 30-DAY GS MAINT ALLOWANCE			(8) 1 YR ALW PER EQUIP CATGCT	(9) DEPOT MAINT ALW PER 100 EQUIP	(10) ILLUSTRATIONS	
					(a) 1-20	(b) 21-50	(c) 51-100	(a) 1-20	(b) 21-50	(c) 51-100			(a) FIG NO.	(b) ITEM NO. OR REFERENCE DESIGNATION
P-F	5905-111-4746	RESISTOR, FIXED, COMPOSITION RC20GF183J (81349) - OR -	EA	1	*	*	*	*	*	*	*	*	3-27	1A5A2R2
P-F	5905-192-0649	RESISTOR, FIXED, COMPOSITION RC20GF203J (81349) - OR -	EA	1	*	*	*	*	*	*	*	*	3-27	1A5A2R2
P-F	5905-171-2004	RESISTOR, FIXED, COMPOSITION RC20GF223J (81349) - OR -	EA	1	*	*	*	*	*	*	*	*	3-27	1A5A2R2
P-F	5905-111-4753	RESISTOR, FIXED, COMPOSITION RC20GF243J (81349) - OR -	EA	1	*	*	*	*	*	*	*	*	3-27	1A5A2R2
P-F	5905-279-3499	RESISTOR, FIXED, COMPOSITION RC20GF273J (81349) - OR -	EA	1	*	*	*	*	*	*	*	*	3-27	1A5A2R2
P-F	5905-116-8569	RESISTOR, FIXED, COMPOSITION RC20GF333J (81349) - OR -	EA	1	*	*	*	*	*	*	*	*	3-27	1A5A2R2
P-F	5905-714-5430	RESISTOR, FIXED, COMPOSITION RC20GF393J (81349) - OR -	EA	1	*	*	*	*	*	*	*	*	3-27	1A5A2R2
P-F	5905-106-3491	RESISTOR, FIXED, COMPOSITION RC20GF433J (81349)	EA	1	*	*	*	*	*	*	*	*	3-27	1A5A2R2
P-F	5310-058-2949	WASHER, LOCK MS35337-78 (96906)	EA	REF	*	*	*	*	*	*	*	*		
P-F	5910-849-0714	CAPACITOR, SELECT FROM CAPACITOR, FIXED, MICA DIELECTRIC IML5E261F0500W4CR (72136) - OR -	EA	1	*	*	*	*	*	*	*	*	3-27	1A5A2C3
P-F	5910-027-9966	CAPACITOR, FIXED, MICA DIELECTRIC IML5E271F0300W4CR (72136)	EA	1	*	*	*	*	*	*	*	*	3-27	1A5A2C3
X1-F		PLATE, COVER 756-4032-002 (13499)	EA	1										
X2-F		PLATE, COVER 542-7696-003 (13499)	EA	REF										
X1-F		PLATE, COVER 756-4033-002 (13499)	EA	1										
X2-F		PLATE, COVER 542-7696-003 (13499)	EA	REF										
A-F		MODULATOR, BALANCED 543-1351-004 (13499)	EA	1									3-18	1A5A3
P-F	5305-054-5648	SCREW, MACHINE MS51957-14 (96906)	EA	REF	*	*	*	*	*	*	*	*		
P-F	5305-770-2533	SCREW, MACHINE MS51959-13 (96906)	EA	REF	*	*	*	*	*	*	*	*		
P-H	5310-614-3500	NUT, SELF-LOCKING 68-1660-40 (72962)	EA	REF										
P-F	5310-042-9609	WASHER, LOCK MS35338-78 (96906)	EA	REF	*	*	*	*	*	*	*	*		
X2-F		BASE, ROLLED 543-1360-002 (13499)	EA	1										
P-H		PIN, LOCATING 541-6559-002 (13499)	EA	1				*	*	*	*	*		
X2-F		PLATE, BASE 543-1361-003 (13499)	EA	1										
X2-F		PLATE, CASTING 543-1494-014 (13499)	EA	REF										
P-H		PIN, LOCATING 544-9300-002 (13499)	EA	1				*	*	*	*	*		
X2-F		CHASSIS, ELECTRICAL EQUIPMENT 543-1366-002 (13499)	EA	1				*	*	*	*	*		
P-H		NUT, PLAIN, CLINCH 543-1368-002 (13499)	EA	10				*	*	*	*	*		
X2-F		CHASSIS, ELECTRICAL EQUIPMENT 543-1367-003 (13499)	EA	1										



SECTION III REPAIR PARTS FOR DIRECT SUPPORT, GENERAL SUPPORT, AND DEPOT MAINTENANCE (CONTINUED)

(1) SIR CODE	(2) FEDERAL STOCK NUMBER	(3) DESCRIPTION  REFERENCE NUMBER & MFR. CODE	(4) UNIT OF MEAS	(5) QTY INC IN UNIT	(6) 30-DAY DS MAINT ALLOWANCE			(7) 30-DAY GS MAINT ALLOWANCE			(8) I YR ALW PER EQUIP CATGCT	(9) DEPOT MAINT ALW PER 100 EQUIP	(10) ILLUSTRATIONS	
					(a) 1-20	(b) 21-50	(c) 51-100	(a) 1-20	(b) 21-50	(c) 51-100			(a) FIG NO.	(b) ITEM NO. OR REFERENCE DESIGNATION
P-R		SCREW, SHOULDERED 542-7683-002 (13499)	EA	REF				*	*	*	*	*		
X2-F		FRAME, MODIFIED 543-1369-002 (13499)	EA	1										
X2-F	5320-117-6010	RIVET, SOLID MS20426AD2-3 (96906)	EA	REF										
X2-F		FRAME, MODULATOR 543-1370-003 (13499)	EA	1										
P-R		BRACKET, RETAINING 542-7768-002 (13499)	EA	REF				*	*	*	*	*		
A-F		MODULATOR SUBASSEMBLY 543-1352-003 (13499)	EA	1										1A5A3A1
P-H	5910-688-2993	CAPACITOR, FIXED, PAPER DIELECTRIC 186P10301S3 (56289)	EA	2				*	*	*	*	*	3-29	1A5A3A1C1
P-H	5910-688-2993	CAPACITOR, FIXED, PAPER DIELECTRIC 186P10301S3 (56289)	EA	REF				*	*	*	*	*	3-29	1A5A3A1C2
P-H	5910-984-4144	CAPACITOR, FIXED, MICA DIELECTRIC 22H5T24EG (14655)	EA	2				*	*	*	*	*		1A5A3A1C3
P-H	5910-984-4144	CAPACITOR, FIXED, MICA DIELECTRIC 22H5T24EG (14655)	EA	REF				*	*	*	*	*		1A5A3A1C4
P-F	5905-106-9344	RESISTOR, FIXED, COMPOSITION RC20GF101J (81349)	EA	2	*	*	*	*	*	*	*	*	3-29	1A5A3A1R1
P-F	5905-106-9344	RESISTOR, FIXED, COMPOSITION RC20GF101J (81349)	EA	REF	*	*	*	*	*	*	*	*	3-29	1A5A3A1R2
P-H	5905-171-2005	RESISTOR, FIXED, COMPOSITION RC20GF471K (81349)	EA	4				*	*	*	*	*	3-29	1A5A3A1R3
P-H	5905-171-2005	RESISTOR, FIXED, COMPOSITION RC20GF471K (81349)	EA	REF				*	*	*	*	*	3-29	1A5A3A1R4
P-H	5905-171-2005	RESISTOR, FIXED, COMPOSITION RC20GF471K (81349)	EA	REF				*	*	*	*	*	3-29	1A5A3A1R5
P-H	5905-171-2005	RESISTOR, FIXED, COMPOSITION RC20GF471K (81349)	EA	REF				*	*	*	*	*	3-29	1A5A3A1R6
P-F	5905-542-7641	RESISTOR, FIXED, WIRE WOUND R842-24 (01686)	EA	2	*	*	*	*	*	*	*	*	3-29	1A5A3A1R9
P-F	5905-542-7641	RESISTOR, FIXED, WIRE WOUND R842-24 (01686)	EA	REF	*	*	*	*	*	*	*	*	3-29	1A5A3A1R10
P-F	5905-914-4381	RESISTOR, VARIABLE 3010L1-201 (80294)	EA	2	*	*	*	*	*	*	*	*	3-29	1A5A3A1R7
P-F	5905-914-4381	RESISTOR, VARIABLE 3010L1-201 (80294)	EA	REF	*	*	*	*	*	*	*	*	3-29	1A5A3A1R8
P-R	5950-594-1217	COIL, RADIO FREQUENCY 18-124 (09250)	EA	2				*	*	*	*	*	3-29	1A5A3A1L1
P-H	5950-594-1217	COIL, RADIO FREQUENCY 18-124 (09250)	EA	REF				*	*	*	*	*	3-29	1A5A3A1L2
P-F	5950-583-0999	TRANSFORMER, AUDIO FREQUENCY 23390 (80089)	EA	1	*	*	*	*	*	*	*	*	3-29	1A5A3A1T1
P-F	5961-615-0590	SEMICONDUCTOR DEVICE, DIODE FA4213 (07263)	EA	1	*	*	*	*	*	*	*	*	3-29	1A5A3A1CR1
M-H		INSULATION SLEEVING, ELECTRICAL TEFTW20B (81851)	FT	REF										
M-H		INSULATION SLEEVING, ELECTRICAL TEFTW26-1 (81851)	FT	3										
M-H		INSULATION SLEEVING, ELECTRICAL TEFTW24-2 (81851)	FT	2										

SECTION III REPAIR PARTS FOR DIRECT SUPPORT, GENERAL SUPPORT, AND DEPOT MAINTENANCE (CONTINUED)

(1) S/R CODE	(2) FEDERAL STOCK NUMBER	(3) DESCRIPTION  REFERENCE NUMBER & MFR. CODE	(4) UNIT OF MEAS	(5) QTY INC IN UNIT	(6) 30-DAY DS MAINT ALLOWANCE			(7) 30-DAY GS MAINT ALLOWANCE			(8) 1 YR ALW PER EQUIP CATGCTY	(9) DEPOT MAINT ALW PER 100 EQUIP	(10) ILLUSTRATIONS	
					(a) 1-20	(b) 21-50	(c) 51-100	(a) 1-20	(b) 21-50	(c) 51-100			(a) FIG NO.	(b) ITEM NO. OR REFERENCE DESIGNATION
M-H		INSULATION SLEEVING, ELECTRICAL TEFTW24-3 (81851)	FT	REF										
M-H		INSULATION SLEEVING, ELECTRICAL TEFTW24-5 (81851)	FT	REF										
M-H		INSULATION SLEEVING, ELECTRICAL TEFTW24-6 (81851)	FT	REF										
M-H		INSULATION SLEEVING, ELECTRICAL TEFTW26-1 (81851)	FT	REF										
M-H		WIRE, ELECTRICAL 00702-1320 (70567)	FT	REF										
X2-H		SHIELD 543-1359-002 (13499)	EA	2										
M-H		CABLE, RADIO FREQUENCY RG196AU (80058)	FT	REF										
P-H	599-790-0589	TERMINAL BOARD 543-1354-002 (13499)	EA	1				*	*	*	*	*		1A5A3A1T81
X1-H		RIVET, TUBULAR MS16535-65 (96906)	EA	4										
X1-H		EYELET, METALLIC SE24CADPL (90030)	EA	REF										
X1-H		EYELET, METALLIC A2059ELECTROTIN (57771)	EA	122										
P-H		CLIP, ELECTRICAL 543-1363-002 (13499)	EA	2				*	*	*	*	*		
X2-H		BRACKET, ANGLE 543-1365-002 (13499)	EA	4										
X1-H		PRINTED CIRCUIT BOARD 543-1355-003 (13499)	EA	1										
P-H	5935-615-3914	JACK, TIP SKT2BC (98291)	EA	2				*	*	*	*	*	3-29	1A5A3A1J1
P-H	5935-615-3914	JACK, TIP SKT2BC (98291)	EA	REF				*	*	*	*	*	3-29	1A5A3A1J2
P-F		TERMINAL, STUD 545-3205-002 (13499)	EA	REF	*	*	*	*	*	*	*	*		
P-F	5305-054-5646	SCREW, MACHINE MS51957-12 (96906)	EA	REF	*	*	*	*	*	*	*	*		
P-F	5305-054-5640	SCREW, MACHINE MS51957-6 (96906)	EA	REF	*	*	*	*	*	*	*	*		
P-F		NUT, PLAIN, HEXAGON P313-0132-000 (77250)	EA	REF	*	*	*	*	*	*	*	*		
P-F	5310-271-4640	NUT, PLAIN, HEXAGON MS35649-24 (96906)	EA	REF	*	*	*	*	*	*	*	*		
P-F	5915-615-3952	FILTER, BANDPASS 526-9312-000 (13499)	EA	1	*	*	*	*	*	*	*	*	3-29	1A5A3A1FL1
P-F	5905-171-1997	RESISTOR, FIXED, COMPOSITION RC20GF331K (81349)	EA	1	*	*	*	*	*	*	*	*	3-29	1A5A3A1RL3
P-F	5905-171-2009	RESISTOR, FIXED, COMPOSITION RC20GF222K (81349)	EA	1	*	*	*	*	*	*	*	*	3-29	1A5A3A1RL4
P-F	5310-042-9609	WASHER, LOCK MS35338-78 (96906)	EA	REF	*	*	*	*	*	*	*	*		
P-F	5305-054-5647	SCREW, MACHINE MS1957-12 (96906)	EA	REF	*	*	*	*	*	*	*	*		
P-F		NUT, PLAIN, HEXAGON P313-0156-000 (77250)	EA	REF	*	*	*	*	*	*	*	*		

SECTION III REPAIR PARTS FOR DIRECT SUPPORT, GENERAL SUPPORT, AND DEPOT MAINTENANCE (CONTINUED)

(1) SIB CODE	(2) FEDERAL STOCK NUMBER	(3) DESCRIPTION  REFERENCE NUMBER & VER. CODE	(4) UNIT OF MEAS	(5) QTY INC IN UNIT	(6) 30-DAY DS MAINT ALLOWANCE			(7) 30-DAY GS MAINT ALLOWANCE			(8) 1 YR ALW PER EQUIP CNTGCT	(9) DEPOT MAINT ALW PER 100 EQUIP	(10) ILLUSTRATIONS	
					(a) 1-30	(b) 31-60	(c) 61-100	(a) 1-20	(b) 21-50	(c) 51-100			(a) FIG NO.	(b) ITEM NO. OR REFERENCE DESIGNATION
P-H		CLAMP, FILTER 543-1364-002 (13499)	EA	2				*	*	*	*			
P-F	5905-848-8924	RESISTOR, FIXED, FILM RN60C5110F (81349)	EA	4	*	*	*	*	*	*	*	3-29	1A5A3A1R11	
P-F	5905-848-8924	RESISTOR, FIXED, FILM RN60C5110F (81349)	EA	REF	*	*	*	*	*	*	*	3-29	1A5A3A1R12	
P-H		WASHER, FLAT 310-6340-000 (79807)	EA	4				*	*	*	*			
A-F		MODULATOR SUBASSEMBLY 543-1353-003 (13499)	EA	1									1A5A3A2	
P-H	5910-688-2993	CAPACITOR, FIXED, PAPER DIELECTRIC 186P10301S3 (56289)	EA	2				*	*	*	*	3-30	1A5A3A2C1	
P-H	5910-688-2993	CAPACITOR, FIXED, PAPER DIELECTRIC 186P10301S3 (56289)	EA	REF				*	*	*	*	3-30	1A5A3A2C2	
P-H	5905-848-8924	RESISTOR, FIXED, FILM RN60C5110F (81349)	EA	REF				*	*	*	*	3-30	1A5A3A2P11	
P-H	5905-848-8924	RESISTOR, FIXED, FILM RN60C5110F (81349)	EA	REF				*	*	*	*	3-30	1A5A3A2R12	
P-F	5905-106-9344	RESISTOR, FIXED, COMPOSITION RC20GF101J (81349)	EA	2	*	*	*	*	*	*	*	3-30	1A5A3A2R1	
P-F	5905-106-9344	RESISTOR, FIXED, COMPOSITION RC20GF101J (81349)	EA	REF	*	*	*	*	*	*	*	3-30	1A5A3A2R2	
P-H	5905-171-2005	RESISTOR, FIXED, COMPOSITION RC20GF471K (81349)	EA	4				*	*	*	*	3-30	1A5A3A2R3	
P-H	5905-171-2005	RESISTOR, FIXED, COMPOSITION RC20GF471K (81349)	EA	REF				*	*	*	*	3-30	1A5A3A2R4	
P-H	5905-171-2005	RESISTOR, FIXED, COMPOSITION RC20GF471K (81349)	EA	REF				*	*	*	*	3-30	1A5A3A2R5	
P-H	5905-171-2005	RESISTOR, FIXED, COMPOSITION RC20GF471K (81349)	EA	REF				*	*	*	*	3-30	1A5A3A2R6	
P-F	5905-542-7641	RESISTOR, FIXED, WIRE WOUND R842-24 (01686)	EA	2	*	*	*	*	*	*	*	3-30	1A5A3A2R9	
P-F	5905-542-7641	RESISTOR, FIXED, WIRE WOUND R842-24 (01686)	EA	REF	*	*	*	*	*	*	*	3-30	1A5A3A2R10	
P-F	5905-914-438	RESISTOR, VARIABLE 3010L1-201 (80294)	EA	2	*	*	*	*	*	*	*	3-30	1A5A3A2R7	
P-F	5905-914-4381	RESISTOR, VARIABLE 3010L1-201 (80294)	EA	REF	*	*	*	*	*	*	*	3-30	1A5A3A2R8	
P-H	5910-984-4144	CAPACITOR, FIXED, MICA DIELECTRIC 22H5T24EG (14655)	EA	2				*	*	*	*		1A5A3A2C3	
P-H	5910-984-4144	CAPACITOR, FIXED, MICA DIELECTRIC 22H5T24EG (14655)	EA	REF				*	*	*	*		1A5A3A2C4	
P-H	5950-594-1217	COIL, RADIO FREQUENCY 18-124 (09250)	EA	2				*	*	*	*	3-30	1A5A3A2L1	
P-H	5950-594-1217	COIL, RADIO FREQUENCY 18-124 (09250)	EA	REF				*	*	*	*	3-30	1A5A3A2L2	
P-F	5950-583-0999	TRANSFORMER, AUDIO FREQUENCY 25390 (80089)	EA	1	*	*	*	*	*	*	*	3-30	1A5A3A2T1	
P-F	5961-615-0590	SEMICONDUCTOR DEVICE, DIODE FA4213 (07263)	EA	1	*	*	*	*	*	*	*	3-30	1A5A3A2CR1	
M-H		INSULATION SLEEVING, ELECTRICAL TPTW20B (81851)	FT	REF										
M-H		INSULATION SLEEVING, ELECTRICAL TPTW26-1 (81851)	FT	REF										

SECTION III REPAIR PARTS FOR DIRECT SUPPORT, GENERAL SUPPORT, AND DEPOT MAINTENANCE (CONTINUED)

(1) SRR CODE	(2) FEDERAL STOCK NUMBER	(3) DESCRIPTION  REFERENCE NUMBER & MFR. CODE	(4) UNIT OF MEAS	(5) QTY INC IN UNIT	(6) 30-DAY DS MAINT ALLOWANCE			(7) 30-DAY GS MAINT ALLOWANCE			(8) 1 YR ALW PER EQUIP CNTQCY	(9) DEPOT MAINT ALW PER 100 EQUIP	(10) ILLUSTRATIONS	
					(a) 1-20	(b) 21-50	(c) 51-100	(a) 1-20	(b) 21-50	(c) 51-100			(a) FIG NO.	(b) ITEM NO. OR REFERENCE DESIGNATION
M-H		INSULATION SLEEVING, ELECTRICAL TEFTW24-2 (81851)	FT	REF										
M-H		INSULATION SLEEVING, ELECTRICAL TEFTW24-3 (81851)	FT	REF										
M-H		INSULATION SLEEVING, ELECTRICAL TEFTW24-5 (81851)	FT	REF										
M-H		INSULATION SLEEVING, ELECTRICAL TEFTW24-6 (81851)	FT	REF										
M-H		INSULATION SLEEVING, ELECTRICAL TEFTW24-7 (81851)	FT	1										
M-H		WIRE, ELECTRICAL 00702-1320 (70567)	FT	REF										
X2-H		SHIELD 543-1359-002 (13499)	EA	REF										
M-H		CABLE, RADIO FREQUENCY RG196AU (80058)	FT	REF										
P-F	5915-583-1964	FILTER, BANDPASS 526-9311-000 (13499)	EA	1	*	*	*	*	*	*	*	3-30	1A5A3A2F11	
P-H	5999-790-0589	TERMINAL, BOARD 543-1354-002 (13499)	EA	REF				*	*	*	*			
X1-H		RIVET, TUBULAR MS16535-65 (96906)	EA	REF										
X1-H		EYELET, METALLIC SE24CADPL (90030)	EA	REF										
X1-H		EYELET, METALLIC A2059ELECTROTIN (57771)	EA	REF										
P-H		CLIP, ELECTRICAL 543-1365-002 (13499)	EA	REF				*	*	*	*			
X2-H		BRACKET, ANGLE 543-1365-002 (13499)	EA	REF										
X1-H		PRINTED CIRCUIT BOARD 543-1355-003 (13499)	EA	REF										
P-H	5935-615-3914	JACK, TIP SKT2BC (98291)	EA	2				*	*	*	*	3-30	1A5A3A2J1	
P-H	5935-615-3915	JACK, TIP SKT2BC (98291)	EA	REF				*	*	*	*	3-30	1A5A3A2J2	
P-F		TERMINAL, STUD 545-3205-002 (13499)	EA	REF	*	*	*	*	*	*	*			
P-F	5305-054-5646	SCREW, MACHINE MS51957-12 (96906)	EA	REF	*	*	*	*	*	*	*			
P-F	5305-054-5640	SCREW, MACHINE MS51957-6 (96906)	EA	REF	*	*	*	*	*	*	*			
P-F		NUT, PLAIN, HEXAGON P313-0132-000 (77250)	EA	REF	*	*	*	*	*	*	*			
P-F	5310-271-4640	NUT, PLAIN, HEXAGON MS35649-24 (96906)	EA	REF	*	*	*	*	*	*	*			
P-F	5905-171-1997	RESISTOR, FIXED, COMPOSITION RC20GF331K (81349)	EA	1	*	*	*	*	*	*	*	3-30	1A5A3A2R13	
P-F	5905-171-2009	RESISTOR, FIXED, COMPOSITION RC20GF222K (81349)	EA	1	*	*	*	*	*	*	*	3-30	1A5A3A2R14	
P-F	5310-042-9609	WASHER, LOCK MS35338-78 (96906)	EA	REF	*	*	*	*	*	*	*			
P-F	5305-054-5647	SCREW, MACHINE MS51957-13 (96906)	EA	REF	*	*	*	*	*	*	*			

SECTION III REPAIR PARTS FOR DIRECT SUPPORT, GENERAL SUPPORT, AND DEPOT MAINTENANCE (CONTINUED)

(1) SMB CODE	(2) FEDERAL STOCK NUMBER	(3) DESCRIPTION  REFERENCE NUMBER & MFR. CODE  USABLE ON CODE	(4) UNIT OF MEAS	(5) QTY INC IN UNIT	(6) 30-DAY DS MAINT ALLOWANCE			(7) 30-DAY GS MAINT ALLOWANCE			(8) 1 YR ALW PER EQUIP CNTGCT	(9) DEPOT MAINT ALW PER 100 EQUIP	(10) ILLUSTRATIONS	
					(a)	(b)	(c)	(a)	(b)	(c)			(a)	(b)
					1-20	21-50	51-100	1-20	21-50	51-100			FIG NO.	ITEM NO. OR REFERENCE DESIGNATION
P-F		NUT, PLAIN, HEXAGON P313-0156-000 (77250)	EA	REF	*	*	*	*	*	*	*			
P-H		CLAMP, FILTER 543-1364-002 (13499)	EA	REF				*	*	*	*			
P-H		WASHER, FLAT 310-6340-000 (79807)	EA	REF				*	*	*	*			
X2-H		PLATE, COVER 756-4278-002 (13499)	EA	2										
X2-H		PLATE, COVER 542-7696-003 (13499)	EA	REF										
P-H	5910-681-7140	CAPACITOR, SELECT FROM CAPACITOR, FIXED, MICA DIELECTRIC 22H5T18EG (14655) - OR -	EA	1	*	*	*	*	*	*	*	3-29	1A5A3A1C3	
P-H	5910-725-1993	CAPACITOR, FIXED, MICA DIELECTRIC 22H5R2EG (14655) - OR -	EA	1	*	*	*	*	*	*	*	3-29	1A5A3A1C3	
P-H		CAPACITOR, FIXED, MICA DIELECTRIC 22H5T22EG (14655) - OR -	EA	1	*	*	*	*	*	*	*	3-29	1A5A3A1C3	
P-H	5910-663-5850	CAPACITOR, FIXED, MICA DIELECTRIC 22H5T27EG (14655) - OR -	EA	1	*	*	*	*	*	*	*	3-29	1A5A3A1C3	
P-F	5910-993-0098	CAPACITOR, FIXED, MICA DIELECTRIC DM15E191F0500WV4CR (72136) - OR -	EA	1	*	*	*	*	*	*	*	3-29	1A5A3A1C3	
P-F	5910-080-3690	CAPACITOR, FIXED, MICA DIELECTRIC DM15E2320G500WV4CR (72136) - OR -	EA	1	*	*	*	*	*	*	*	3-29	1A5A3A1C3	
P-F	5910-951-6723	CAPACITOR, FIXED, MICA DIELECTRIC DM15E2520G500WV4CR (72136) - OR -	EA	1	*	*	*	*	*	*	*	3-29	1A5A3A1C3	
P-F	5910-849-0714	CAPACITOR, FIXED, MICA DIELECTRIC DM15E261F0500WV4CR (72136) - OR -	EA	1	*	*	*	*	*	*	*	3-29	1A5A3A1C3	
P-F	5910-903-9880	CAPACITOR, FIXED, MICA DIELECTRIC DM15E2670F0300WV4CR (72136)	EA	1	*	*	*	*	*	*	*	3-29	1A5A3A1C3	
P-H	5910-681-7140	CAPACITOR, SELECT FROM CAPACITOR, FIXED, MICA DIELECTRIC 22H5T18EG (14655) - OR -	EA	1	*	*	*	*	*	*	*	3-29	1A5A3A1C4	
P-H	5910-725-1993	CAPACITOR, FIXED, MICA DIELECTRIC 22H5T2EG (14655) - OR -	EA	1	*	*	*	*	*	*	*	3-29	1A5A3A1C4	
P-H		CAPACITOR, FIXED, MICA DIELECTRIC 22H5T22EG (14655) - OR -	EA	1	*	*	*	*	*	*	*	3-29	1A5A3A1C4	
P-H	5910-663-5850	CAPACITOR, FIXED, MICA DIELECTRIC 22H5T27EG (14655) - OR -	EA	1	*	*	*	*	*	*	*	3-29	1A5A3A1C4	
P-F	5910-993-0093	CAPACITOR, FIXED, MICA DIELECTRIC DM15E191F0500WV4CR (72136) - OR -	EA	1	*	*	*	*	*	*	*	3-29	1A5A3A1C4	
P-F	5910-080-3690	CAPACITOR, FIXED, MICA DIELECTRIC DM15E2320G500WV4CR (72136) - OR -	EA	1	*	*	*	*	*	*	*	3-29	1A5A3A1C4	
P-F	5910-951-6723	CAPACITOR, FIXED, MICA DIELECTRIC DM15E2520G500WV4CR (72136) - OR -	EA	1	*	*	*	*	*	*	*	3-29	1A5A3A1C4	
P-F	5910-849-0714	CAPACITOR, FIXED, MICA DIELECTRIC DM15E261F0500WV4CR (72136) - OR -	EA	1	*	*	*	*	*	*	*	3-29	1A5A3A1C4	
P-F	5910-903-9880	CAPACITOR, FIXED, MICA DIELECTRIC DM15E2670F0300WV4CR (72136)	EA	1	*	*	*	*	*	*	*	3-29	1A5A3A1C4	
P-H	5910-681-7140	CAPACITOR, SELECT FROM CAPACITOR, FIXED, MICA DIELECTRIC 22H5T18EG (14655) - OR -	EA	1	*	*	*	*	*	*	*	3-30	1A5A3A2C3	
P-H	5910-725-1993	CAPACITOR, FIXED, MICA DIELECTRIC 22H5T2EG (14655) - OR -	EA	1	*	*	*	*	*	*	*	3-30	1A5A3A2C3	
P-H		CAPACITOR, FIXED, MICA DIELECTRIC 22H5T22EG (14655) - OR -	EA	1	*	*	*	*	*	*	*	3-30	1A5A3A2C3	
P-H	5910-663-5850	CAPACITOR, FIXED, MICA DIELECTRIC 22H5T27EG (14655) - OR -	EA	1	*	*	*	*	*	*	*	3-30	1A5A3A2C3	

SECTION III REPAIR PARTS FOR DIRECT SUPPORT, GENERAL SUPPORT, AND DEPOT MAINTENANCE (CONTINUED)

(1) S/R CODE	(2) FEDERAL STOCK NUMBER	(3) DESCRIPTION  REFERENCE NUMBER & MFR. CODE	(4) UNIT OF MEAS	(5) QTY INC IN UNIT	(6) 30-DAY DS MAINT ALLOWANCE			(7) 30-DAY GS MAINT ALLOWANCE			(8) 1 YR ALW PER EQUIP CHNGCY	(9) DFFOT MAINT ALW PER 100 EQUIP	(10) ILLUSTRATIONS		
					USABLE ON CODE	(a) 1-20	(b) 21-50	(c) 51-100	(a) 1-20	(b) 21-50			(c) 51-100	(a) FIG NO.	(b) ITEM NO. OR REFERENCE DESIGNATION
P-F	5910-993-0098	CAPACITOR, FIXED, MICA DIELECTRIC DM15E191FO500WV4CR (72136) - OR -	EA	1	*	*	*	*	*	*	*	*	3-30	1A5A3A2C3	
P-F	5910-080-3690	CAPACITOR, FIXED, MICA DIELECTRIC DM15E2320G0500WV4CR (72136) - OR -	EA	1	*	*	*	*	*	*	*	*	3-30	1A5A3A2C3	
P-F	5910-951-6723	CAPACITOR, FIXED, MICA DIELECTRIC DM15E2520G0500WV4CR (72136) - OR -	EA	1	*	*	*	*	*	*	*	*	3-30	1A5A3A2C3	
P-F	5910-849-0714	CAPACITOR, FIXED, MICA DIELECTRIC DM15E261FO500WV4CR (72136) - OR -	EA	1	*	*	*	*	*	*	*	*	3-30	1A5A3A2C3	
P-F	5910-903-9880	CAPACITOR, FIXED, MICA DIELECTRIC DM15E2670FO300WV4CR (72136) - OR -	EA	1	*	*	*	*	*	*	*	*	3-30	1A5A3A2C3	
P-H	5910-681-7140	CAPACITOR; SELECT FRGM CAPACITOR, FIXED, MICA DIELECTRIC 22H5T18EG (14655) - OR -	EA	1	*	*	*	*	*	*	*	*	3-30	1A5A3A2C4	
P-H	5910-725-1993	CAPACITOR, FIXED, MICA DIELECTRIC 22H5T2EG (14655) - OR -	EA	1	*	*	*	*	*	*	*	*	3-30	1A5A3A2C4	
P-H		CAPACITOR, FIXED, MICA DIELECTRIC 22H5T22EG (14655) - OR -	EA	1	*	*	*	*	*	*	*	*	3-30	1A5A3A2C4	
P-H	5910-663-5850	CAPACITOR, FIXED, MICA DIELECTRIC 22H5T27EG (14655) - OR -	EA	1	*	*	*	*	*	*	*	*	3-30	1A5A3A2C4	
P-F	5910-993-0098	CAPACITOR, FIXED, MICA DIELECTRIC DM15E191FO500WV4CR (72136) - OR -	EA	1	*	*	*	*	*	*	*	*	3-30	1A5A3A2C4	
P-F	5910-080-3690	CAPACITOR, FIXED, MICA DIELECTRIC DM15E2320G0500WV4CR (72136) - OR -	EA	1	*	*	*	*	*	*	*	*	3-30	1A5A3A2C4	
P-F	5910-951-6723	CAPACITOR, FIXED, MICA DIELECTRIC DM15E2520G0500WV4CR (72136) - OR -	EA	1	*	*	*	*	*	*	*	*	3-30	1A5A3A2C4	
P-F	5910-849-0714	CAPACITOR, FIXED, MICA DIELECTRIC DM15E261FO500WV4CR (72136) - OR -	EA	1	*	*	*	*	*	*	*	*	3-30	1A5A3A2C4	
P-F	5910-903-9880	CAPACITOR, FIXED, MICA DIELECTRIC DM15E2670FO300WV4CR (72136) - OR -	EA	1	*	*	*	*	*	*	*	*	3-30	1A5A3A2C4	
P-F	5910-772-1217	CAPACITOR; SELECT FRGM CAPACITOR, FIXED, MICA DIELECTRIC 22H5Q91EG (14655) - OR -	EA	1	*	*	*	*	*	*	*	*	3-29	1A5A3A1C5	
P-H	5910-717-0169	CAPACITOR, FIXED, MICA DIELECTRIC 22H5T1EG (14655) - OR -	EA	1	*	*	*	*	*	*	*	*	3-29	1A5A3A1C5	
P-F	5910-727-3991	CAPACITOR, FIXED, MICA DIELECTRIC 22H5T11EG (14655) - OR -	EA	1	*	*	*	*	*	*	*	*	3-29	1A5A3A1C5	
P-F	5910-663-4562	CAPACITOR, FIXED, MICA DIELECTRIC 22H5T12EG (14655) - OR -	EA	1	*	*	*	*	*	*	*	*	3-29	1A5A3A1C5	
P-F	5910-766-8790	CAPACITOR, FIXED, MICA DIELECTRIC 22H5T13EG (14655) - OR -	EA	1	*	*	*	*	*	*	*	*	3-29	1A5A3A1C5	
P-F	5910-990-5413	CAPACITOR, FIXED, MICA DIELECTRIC DM15E960FO500WV4CR (72136) - OR -	EA	1	*	*	*	*	*	*	*	*	3-29	1A5A3A1C5	
P-F	5910-810-8264	CAPACITOR, FIXED, MICA DIELECTRIC DM15E1050FO500WV4CR (72136) - OR -	EA	1	*	*	*	*	*	*	*	*	3-29	1A5A3A1C5	
P-F	5910-854-8543	CAPACITOR, FIXED, MICA DIELECTRIC DM15E1070FC300WV4CR (72136) - OR -	EA	2	*	*	*	*	*	*	*	*	3-29	1A5A3A1C5	
P-F	5910-080-3688	CAPACITOR, FIXED, MICA DIELECTRIC DM15E114CG0500WV4CR (72136) - OR -	EA	1	*	*	*	*	*	*	*	*	3-29	1A5A3A1C5	
P-F	5910-960-7347	CAPACITOR, FIXED, MICA DIELECTRIC DM15E1270FO500WV4CR (72136) - OR -	EA	1	*	*	*	*	*	*	*	*	3-29	1A5A3A1C5	
P-F	5910-988-4314	CAPACITOR, FIXED, MICA DIELECTRIC DM15E130FO500WV4CR (72136) - OR -	EA	1	*	*	*	*	*	*	*	*	3-29	1A5A3A1C5	
P-F	5910-772-1217	CAPACITOR, FIXED, MICA DIELECTRIC 22H5Q91EG (14655) - OR -	EA	1	*	*	*	*	*	*	*	*	3-30	1A5A3A2C5	
P-F	5910-717-0169	CAPACITOR, FIXED, MICA DIELECTRIC 22H5T1EG (14655) - OR -	EA	1	*	*	*	*	*	*	*	*	3-30	1A5A3A2C5	

TM 11-5820-555-24P  
SECTION III REPAIR PARTS FOR DIRECT SUPPORT, GENERAL SUPPORT, AND DEPOT MAINTENANCE (CONTINUED)

(1) SQR CODE	(2) FEDERAL STOCK NUMBER	(3) DESCRIPTION  REFERENCE NUMBER & MFR. CODE	(4) UNIT OF MEAS	(5) QTY INC IN UNIT	(6) 30-DAY DS MAINT ALLOWANCE			(7) 30-DAY GS MAINT ALLOWANCE			(8) 1 YR ALW PER EQUIP CNTGCT	(9) DEPOT MAINT ALW PER 100 EQUIP	(10) ILLUSTRATIONS	
					(a) 1-20	(b) 21-50	(c) 51-100	(a) 1-20	(b) 21-50	(c) 51-100			(a) FIG NO.	(b) ITEM NO. OR REFERENCE DESIGNATION
P-F	5910-727-3991	CAPACITOR, FIXED, MICA DIELECTRIC 22H5T11EG (14655) - OR -	EA	1	*	*	*	*	*	*	*	*	3-30	1A5A3A2C5
P-F	5910-663-4562	CAPACITOR, FIXED, MICA DIELECTRIC 22H5T12EG (14655) - OR -	EA	1	*	*	*	*	*	*	*	*	3-30	1A5A3A2C5
P-F	5910-766-8790	CAPACITOR, FIXED, MICA DIELECTRIC 22H5T13EG (14655) - OR -	EA	1	*	*	*	*	*	*	*	*	3-30	1A5A3A2C5
P-F	5910-990-5413	CAPACITOR, FIXED, MICA DIELECTRIC DM15E960F0500WV4CR (72136) - OR -	EA	1	*	*	*	*	*	*	*	*	3-30	1A5A3A2C5
P-F	5910-810-8264	CAPACITOR, FIXED, MICA DIELECTRIC DM15E1050F0500WV4CR (72136) - OR -	EA	1	*	*	*	*	*	*	*	*	3-30	1A5A3A2C5
P-F	5910-854-8543	CAPACITOR, FIXED, MICA DIELECTRIC DM15E1070F0300WV4CR (72136) - OR -	EA	1	*	*	*	*	*	*	*	*	3-30	1A5A3A2C5
P-F	5910-080-3688	CAPACITOR, FIXED, MICA DIELECTRIC DM15E114CG0500WV4CR (72136) - OR -	EA	1	*	*	*	*	*	*	*	*	3-30	1A5A3A2C5
P-F	5910-960-7347	CAPACITOR, FIXED, MICA DIELECTRIC DM15E1270F0500WV4CR (72136) - OR -	EA	1	*	*	*	*	*	*	*	*	3-30	1A5A3A2C5
P-F	5910-988-4314	CAPACITOR, FIXED, MICA DIELECTRIC DM15E1330F0500WV4CR (72136) - OR -	EA	1	*	*	*	*	*	*	*	*	3-30	1A5A3A2C5
P-C		KIT, MOUNTING 541-1477-002 (13499)	EA	REF	*	*	*	*	*	*	*	*		
M-H		BAG, COTTON 024-0100-000 (13499)	EA	REF	*	*	*	*	*	*	*	*		
P-O	5310-054-1830	WASHER, LOCK MS35338-80 (96906)	EA	REF	*	*	*	*	*	*	*	*		
P-C		WASHER, FLAT 310-0167-000 (79807)	EA	REF	*	*	*	*	*	*	*	*		
P-O		WASHER, LOCK 310-0286-000 (13499)	EA	REF	*	*	*	*	*	*	*	*		
P-O	5305-579-3507	SCREW, MACHINE MS35216-40 (96906)	EA	REF	*	*	*	*	*	*	*	*		
P-C		SCREW, MACHINE F343-0247-000 (77250)	EA	REF	*	*	*	*	*	*	*	*		
P-F	5305-054-6653	SCREW, MACHINE MS51957-29 (96906)	EA	REF	*	*	*	*	*	*	*	*		
A-F		AMPLIFIER ASSEMBLY, INTERMEDIATE FREQUENCY 743-0276-005 (13499)	EA	1									3-18	1A5A6
P-F	5960-264-1028	SHIELD, ELECTRON 141-0223-000 (13499)	EA	REF	*	*	*	*	*	*	*	*	3-31	1A5A6E1
P-F	5310-595-5421	WASHER, FLAT 310-6320-003 (79807)	EA	REF	*	*	*	*	*	*	*	*		
P-F		INSULATION SLEEVING, ELECTRICAL TEFTW22B (81851)	FT	REF	*	*	*	*	*	*	*	*		
M-H		INSULATION SLEEVING, ELECTRICAL TEFTW22-3 (81851)	FT	REF	*	*	*	*	*	*	*	*		
M-H		INSULATION SLEEVING, ELECTRICAL TEFTW22-1 (81851)	FT	REF	*	*	*	*	*	*	*	*		
M-H		INSULATION SLEEVING, ELECTRICAL TEFTW22-0 (81851)	FT	REF	*	*	*	*	*	*	*	*		
XI-H		INSULATION SLEEVING, ELECTRICAL TEFTW22-6 (81851)	FT	REF	*	*	*	*	*	*	*	*		
M-H		INSULATION SLEEVING, ELECTRICAL TEFTW-2-5 (81851)	FT	REF	*	*	*	*	*	*	*	*		
M-H		INSULATION SLEEVING, ELECTRICAL TEFTW22-4 (81851)	FT	REF	*	*	*	*	*	*	*	*		

SECTION III REPAIR PARTS FOR DIRECT SUPPORT, GENERAL SUPPORT, AND DEPOT MAINTENANCE (CONTINUED)

(1) SR CODE	(2) FEDERAL STOCK NUMBER	(3) DESCRIPTION  REFERENCE NUMBER & MFR. CODE	(4) UNIT OF MEAS	(5) QTY INC IN UNIT	(6) 30-DAY DS MAINT ALLOWANCE			(7) 30-DAY GS MAINT ALLOWANCE			(8) 1 YR ALW PER EQUIP CNGCY	(9) DEPOT MAINT ALW PER 100 EQUIP	(10) ILLUSTRATIONS	
					(a) 1-20	(b) 21-50	(c) 51-100	(a) 1-20	(b) 21-50	(c) 51-100			(a) FIG NO.	(b) ITEM NO. OR REFERENCE OF SIGNATURE
P-H	5910-057-5218	CAPACITOR, FIXED, ELECTROLYTIC CL25BJ180TP3 (81349)	EA	1				*	*	*	*	3-32	1A5A6C20	
P-F	5910-992-2070	CAPACITOR, FIXED, ELECTROLYTIC 150D606X0006B2 (56289)	EA	2	*	*	*	*	*	*	*	3-32	1A5A6C18	
P-F	5910-992-2070	CAPACITOR, FIXED, ELECTROLYTIC 150D606X0006B2 (56289)	EA	REF	*	*	*	*	*	*	*	3-32	1A5A6C19	
P-H	5960-256-9989	ELECTRON TUBE 5899 (82219)	EA	4				*	*	*	*	3-31	1A5A6V1	
P-H	5960-256-9989	ELECTRON TUBE 5899 (82219)	EA	REF				*	*	*	*	3-32	1A5A6V2	
P-H	5960-256-9989	ELECTRON TUBE 5899 (82219)	EA	REF				*	*	*	*	3-32	1A5A6V3	
P-H	5960-256-9989	ELECTRON TUBE 5899 (82219)	EA	REF				*	*	*	*	3-32	1A5A6V4	
P-F	5305-054-5647	SCREW, MACHINE MS1957-13 (96906)	EA	REF	*	*	*	*	*	*	*			
P-H	5310-622-1724	NUT, SELF-LOCKING, HEXAGON 68-1660-26 (72962)	EA	REF				*	*	*	*			
P-H	5310-614-3500	NUT, SELF-LOCKING, HEXAGON 68-1660-40 (72962)	EA	REF				*	*	*	*			
P-F	5305-770-2533	SCREW, MACHINE MS1959-13 (96906)	EA	REF	*	*	*	*	*	*	*			
P-F	5305-763-7822	SCREW, MACHINE MS1959-14 (96906)	EA	REF	*	*	*	*	*	*	*			
P-F	5305-727-8833	SCREW, MACHINE MS1959-3 (96906)	EA	REF	*	*	*	*	*	*	*			
P-H	5305-054-5636	SCREW, MACHINE MS1957-2 (96906)	EA	REF	*	*	*	*	*	*	*			
P-F	5305-054-5640	SCREW, MACHINE MS1957-6 (96906)	EA	REF	*	*	*	*	*	*	*			
P-H	5961-818-4487	TRANSISTOR 2N1150 (07688)	EA	1				*	*	*	*	3-32	1A5A6Q1	
P-F	5961-553-7012	TRANSISTOR 2N243 (07688)	EA	2	*	*	*	*	*	*	*	3-32	1A5A6Q2	
F-F	5961-553-7012	TRANSISTOR 2N243 (07688)	EA	REF	*	*	*	*	*	*	*	3-32	1A5A6Q3	
P-H	5935-057-2690	CONNECTOR, RECEPTACLE, ELECTRICAL DA15P (71468)	EA	1				*	*	*	*	3-31	1A5A6P1	
P-F	5905-556-7917	RESISTOR, VARIABLE 3010L1-102 (80294)	EA	1	*	*	*	*	*	*	*		1A5A6R31	
P-H	5961-866-0476	SEMICONDUCTOR DEVICE, DIODE 1N457 (07688)	EA	3				*	*	*	*	3-32	1A5A6CR1	
P-H	5961-866-0476	SEMICONDUCTOR DEVICE, DIODE 1N457 (07688)	EA	REF				*	*	*	*	3-31	1A5A6CR2	
P-H	5961-866-0476	SEMICONDUCTOR DEVICE, DIODE 1N457 (07688)	EA	REF				*	*	*	*	3-32	1A5A6CR3	
M-H		WIRE, ELECTRICAL 00702-132 (70967)	FT	REF										
M-H		WIRE, ELECTRICAL MILW16878TYPE2-9 (81349)	FT	REF										
M-H		WIRE, ELECTRICAL MILW16878TYPE22-9C (81349)	FT	REF										
M-H		WIRE, ELECTRICAL MILW16878TYPE2-91 (81349)	FT	REF										



SECTION III REPAIR PARTS FOR DIRECT SUPPORT, GENERAL SUPPORT, AND DEPOT MAINTENANCE (CONTINUED)

(1) SQR CODE	(2) FEDERAL STOCK NUMBER	(3) DESCRIPTION  REFERENCE NUMBER & MFR. CODE	(4) UNIT OF MEAS	(5) QTY INC IN UNIT	(6) 30-DAY DS MAINT ALLOWANCE			(7) 30-DAY GS MAINT ALLOWANCE			(8) 1 YR ALW PER EQUIP CNTGTY	(9) DEPOT MAINT ALW PER 100 EQUIP	(10) ILLUSTRATIONS	
					(a) 1-20	(b) 21-50	(c) 51-100	(a) 1-20	(b) 21-50	(c) 51-100			(a) FIG NO.	(b) ITEM NO. CR REFERENCE DESIGNATION
P-H		WIRE, ELECTRICAL MILW16878TYPE22-95 (81349)	FT	REF				*	*	*	*	*		
P-H		WIRE, ELECTRICAL MILW16878TYPE22-96 (81349)	FT	REF				*	*	*	*	*		
P-H		WIRE, ELECTRICAL MILW16878TYPE22-905 (81349)	FT	REF				*	*	*	*	*		
P-H		WIRE, ELECTRICAL MILW16878TYPE22-906 (81349)	FT	REF				*	*	*	*	*		
P-H		WIRE, ELECTRICAL MILW16878TYPE22-912 (81349)	FT	REF				*	*	*	*	*		
P-H		WIRE, ELECTRICAL MILW16878TYPE22-915 (81349)	FT	REF				*	*	*	*	*		
P-H		WIRE, ELECTRICAL MILW16878TYPE22-916 (81349)	FT	REF				*	*	*	*	*		
M-H		WIRE, ELECTRICAL MILW16878TYPE22-0 (81349)	FT	REF										
P-F	5915-615-0565	FILTER, MECHANICAL 526-9307-000 (13499)	EA	1	*	*	*	*	*	*	*	*	3-31	1A5A6FL1
A-F		SHIELD, TUBE 542-4782-002 (13499)	EA	3									3-32	1A5A6E2
A-F		SHIELD, TUBE 542-4782-002 (13499)	EA	REF									3-32	1A5A6E3
A-F		SHIELD, TUBE 542-4782-002 (13499)	EA	REF									3-32	1A5A6E4
P-F	5950-080-5710	TRANSFORMER, AUDIO FREQUENCY TS3703 (95088)	EA	1	*	*	*	*	*	*	*	*	3-31	1A5A6T3
P-F	5950-615-0727	TRANSFORMER, AUDIO FREQUENCY 526-6930-000 (13499)	EA	1	*	*	*	*	*	*	*	*	3-32	1A5A6T4
P-H	5905-279-1756	RESISTOR, FIXED, COMPOSITION RC20GF151K (81349)	EA	2				*	*	*	*	*	3-32	1A5A6R3
P-H	5905-279-1756	RESISTOR, FIXED, COMPOSITION RC20GF151K (81349)	EA	REF				*	*	*	*	*	3-31	1A5A6R9
P-F	5905-245-0023	RESISTOR, FIXED, COMPOSITION RC20GF682K (81349)	EA	1	*	*	*	*	*	*	*	*	3-32	1A5A6R16
P-F	5905-141-0591	RESISTOR, FIXED, COMPOSITION RC20GF103K (81349)	EA	2	*	*	*	*	*	*	*	*	3-31	1A5A6R25
P-F	5905-141-0591	RESISTOR, FIXED, COMPOSITION RC20GF103K (81349)	EA	REF	*	*	*	*	*	*	*	*	3-31	1A5A6R26
P-H	5905-190-8879	RESISTOR, FIXED, COMPOSITION RC20GF183K (81349)	EA	1				*	*	*	*	*	3-32	1A5A6R12
P-H	5905-106-1282	RESISTOR, FIXED, COMPOSITION RC20GF223K (81349)	EA	2				*	*	*	*	*	3-31	1A5A6R2
P-H	5905-106-1282	RESISTOR, FIXED, COMPOSITION RC20GF223K (81349)	EA	REF				*	*	*	*	*	3-31	1A5A6R5
P-H	5905-195-6758	RESISTOR, FIXED, COMPOSITION RC20GF273K (81349)	EA	1				*	*	*	*	*	3-32	1A5A6R8
P-H	5905-190-8882	RESISTOR, FIXED, COMPOSITION RC20GF393K (81349)	EA	1				*	*	*	*	*	3-31	1A5A6R13
P-H	5905-106-9345	RESISTOR, FIXED, COMPOSITION RC20GF683J (81349)	EA	2				*	*	*	*	*	3-32	1A5A6R11
P-H	5905-106-9345	RESISTOR, FIXED, COMPOSITION RC20GF683J (81349)	EA	REF				*	*	*	*	*	3-31	1A5A6R29
P-H	5905-106-9348	RESISTOR, FIXED, COMPOSITION RC20GF154K (81349)	EA	1				*	*	*	*	*	3-32	1A5A6R15

TM 11-5820-555-24P  
SECTION III REPAIR PARTS FOR DIRECT SUPPORT, GENERAL SUPPORT, AND DEPOT MAINTENANCE (CONTINUED)

(1) SNR CODE	(2) FEDERAL STOCK NUMBER	(3) DESCRIPTION  REFERENCE NUMBER & MFR. CODE	(4) UNIT OF MEAS	(5) QTY INC IN UNIT	(6) 30-DAY DS MAINT ALLOWANCE			(7) 30-DAY GS MAINT ALLOWANCE			(8) 1 YR ALW PER EQUIP CNTGTY	(9) DEPOT MAINT ALW PER 100 EQUIP	(10) ILLUSTRATIONS		
					USABLE ON CODE	(a)	(b)	(c)	(a)	(b)			(c)	(a) FIG NO.	(b) ITEM NO. OR REFERENCE DESIGNATION
						1-20	21-50	51-100	1-20	21-50			51-100		
P-H	5905-192-0662	RESISTOR, FIXED, COMPOSITION RC20GF184K (81349)	EA	1				*	*	*	*	*	3-31	1A5A6R14	
P-H	5905-221-5862	RESISTOR, FIXED, COMPOSITION RC20GF334K (81349)	EA	1				*	*	*	*	*	3-31	1A5A6R24	
P-F	5905-114-5388	RESISTOR, FIXED, COMPOSITION RC20GF220K (81349)	EA	2	*	*	*	*	*	*	*	*	3-31	1A5A6R21	
P-F	5905-114-5388	RESISTOR, FIXED, COMPOSITION RC20GF220K (81349)	EA	REF	*	*	*	*	*	*	*	*	3-31	1A5A6R22	
P-F	5905-106-9344	RESISTOR, FIXED, COMPOSITION RC20GF101J (81349)	EA	1	*	*	*	*	*	*	*	*	3-31	1A5A6R20	
P-F	5905-141-1311	RESISTOR, FIXED, COMPOSITION RC32GF202J (81349)	EA	1	*	*	*	*	*	*	*	*	3-31	1A5A6R18	
P-F	5905-133-0381	RESISTOR, FIXED, COMPOSITION RC32GF562K (81349)	EA	4	*	*	*	*	*	*	*	*	3-31	1A5A6R4	
P-F	5905-133-0381	RESISTOR, FIXED, COMPOSITION RC32GF562K (81349)	EA	REF	*	*	*	*	*	*	*	*	3-31	1A5A6R7	
P-F	5905-133-0381	RESISTOR, FIXED, COMPOSITION RC32GF562K (81349)	EA	REF	*	*	*	*	*	*	*	*	3-32	1A5A6R10	
P-F	5905-133-0381	RESISTOR, FIXED, COMPOSITION RC32GF562K (81349)	EA	REF	*	*	*	*	*	*	*	*	3-31	1A5A6R28	
P-F	5905-299-2016	RESISTOR, FIXED, COMPOSITION RC32GF993K (81349)	EA	1	*	*	*	*	*	*	*	*	3-32	1A5A6R27	
P-F	5905-253-1231	RESISTOR, FIXED, COMPOSITION RC42GF991K (81349)	EA	1	*	*	*	*	*	*	*	*	3-31	1A5A6R19	
P-F	5910-781-7930	CAPACITOR, SELECT FROM CAPACITOR, FIXED, MICA DIELECTRIC DM5E790003 (81349)	EA	1	*	*	*	*	*	*	*	*	3-31	1A5A6C6	
P-F	5910-006-7106	- OR - CAPACITOR, FIXED, MICA DIELECTRIC DM5E79000300WV4CR (72136)	EA	1	*	*	*	*	*	*	*	*	3-31	1A5A6C6	
P-F	5910-071-1642	- OR - CAPACITOR, FIXED, MICA DIELECTRIC DM5E820003 (81349)	EA	1	*	*	*	*	*	*	*	*	3-31	1A5A6C6	
P-F	5910-811-5919	- OR - CAPACITOR, FIXED, MICA DIELECTRIC DM5E86000300WV4CR (72136)	EA	1	*	*	*	*	*	*	*	*	3-31	1A5A6C6	
P-F	5910-061-7453	- OR - CAPACITOR, FIXED, MICA DIELECTRIC DM5E89000300WV4CR (72136)	EA	1	*	*	*	*	*	*	*	*	3-31	1A5A6C6	
P-F	5910-781-7929	- OR - CAPACITOR, FIXED, MICA DIELECTRIC DM5E970003 (81349)	EA	1	*	*	*	*	*	*	*	*	3-31	1A5A6C6	
P-F	5910-990-5413	- OR - CAPACITOR, FIXED, MICA DIELECTRIC DM5E96000300WV4CR (72136)	EA	1	*	*	*	*	*	*	*	*	3-31	1A5A6C6	
P-F	5910-044-4963	- OR - CAPACITOR, FIXED, MICA DIELECTRIC DM5E10170300WV4CR (72136)	EA	1	*	*	*	*	*	*	*	*	3-31	1A5A6C6	
P-F	5910-810-8264	- OR - CAPACITOR, FIXED, MICA DIELECTRIC DM5E10500300WV4CR (72136)	EA	1	*	*	*	*	*	*	*	*	3-31	1A5A6C6	
P-F	5910-854-8543	- OR - CAPACITOR, FIXED, MICA DIELECTRIC DM5E10700300WV4CR (72136)	EA	1	*	*	*	*	*	*	*	*	3-31	1A5A6C6	
P-F	5910-027-9964	- OR - CAPACITOR, FIXED, MICA DIELECTRIC DM5E11100300WV4CR (72136)	EA	1	*	*	*	*	*	*	*	*	3-31	1A5A6C6	
P-F	5910-080-3688	- OR - CAPACITOR, FIXED, MICA DIELECTRIC DM5E11400300WV4CR (81349)	EA	1	*	*	*	*	*	*	*	*	3-31	1A5A6C6	
P-H	5910-681-7140	CAPACITOR, FIXED, MICA DIELECTRIC 22H5T18EG (14655)	EA	1				*	*	*	*	*	3-31	1A5A6C5	
P-F	5910-683-7478	CAPACITOR, FIXED, MICA DIELECTRIC 22H5T3EG (14655)	EA	1	*	*	*	*	*	*	*	*	3-32	1A5A6C24	
P-F	5910-984-5253	CAPACITOR, FIXED, MICA DIELECTRIC 22H5T33EG (14655)	EA	2	*	*	*	*	*	*	*	*	3-32	1A5A6C14	

SECTION III REPAIR PARTS FOR DIRECT SUPPORT, GENERAL SUPPORT, AND DEPOT MAINTENANCE (CONTINUED)

(1) SIR CODE	(2) FEDERAL STOCK NUMBER	(3) DESCRIPTION  REFERENCE NUMBER & MFR. CODE	(4) UNIT OF MEAS	(5) QTY INC IN UNIT	(6) 30-DAY DS MAINT ALLOWANCE			(7) 30-DAY GS MAINT ALLOWANCE			(8) 1 YR ALM PER EQUIP CNTGCT	(9) DEPOT MAINT ALW PER 100 EQUIP	(10) ILLUSTRATIONS	
					(a) 1-20	(b) 21-50	(c) 51-100	(a) 1-20	(b) 21-50	(c) 51-100			(a) FIG NO.	(b) ITEM NO. OR REFERENCE DESIGNATION
P-F	5910-984-5253	CAPACITOR, FIXED, MICA DIELECTRIC 22H5T33EG (14655)	EA	REF	*	*	*	*	*	*	*	*	3-32	1A5A6C22
P-F	5910-060-9619	CAPACITOR, FIXED, MICA DIELECTRIC 22H5T51EG (14655)	EA	2	*	*	*	*	*	*	*	*	3-32	1A5A6C10
P-F	5910-060-9619	CAPACITOR, FIXED, MICA DIELECTRIC 22H5T51EG (14655)	EA	REF	*	*	*	*	*	*	*	*	3-32	1A5A6C13
P-F	5910-800-0357	CAPACITOR, FIXED, PAPER DIELECTRIC 186P15391S3 (56289)	EA	2	*	*	*	*	*	*	*	*	3-31	1A5A6C1
P-F	5910-800-0357	CAPACITOR, FIXED, PAPER DIELECTRIC 186P15391S3 (56289)	EA	REF	*	*	*	*	*	*	*	*	3-31	1A5A6C7
P-H	5910-835-2175	CAPACITOR, FIXED, PAPER DIELECTRIC SDBLK01103M (53021)	EA	2				*	*	*	*	*	3-31	1A5A6C4
P-H	5910-835-2175	CAPACITOR, FIXED, PAPER DIELECTRIC SDBLK01103M (53021)	EA	REF				*	*	*	*	*	3-31	1A5A6C27
P-H	5910-553-7289	CAPACITOR, FIXED, PAPER DIELECTRIC SDBLK02682M (53021)	EA	1				*	*	*	*	*	3-31	1A5A6C16
P-H	5910-702-7381	CAPACITOR, FIXED, PAPER DIELECTRIC 118P10402S3 (56289)	EA	6				*	*	*	*	*	3-31	1A5A6C2
P-H	5910-702-7381	CAPACITOR, FIXED, PAPER DIELECTRIC 118P10402S3 (56289)	EA	REF				*	*	*	*	*	3-31	1A5A6C8
P-H	5910-702-7381	CAPACITOR, FIXED, PAPER DIELECTRIC 118P10402S3 (56289)	EA	REF				*	*	*	*	*	3-31	1A5A6C11
P-H	5910-702-7381	CAPACITOR, FIXED, PAPER DIELECTRIC 118P10402S3 (56289)	EA	REF				*	*	*	*	*	3-31	1A5A6C21
P-H	5910-702-7381	CAPACITOR, FIXED, PAPER DIELECTRIC 118P10402S3 (56289)	EA	REF				*	*	*	*	*	3-31	1A5A6C23
P-H	5910-702-7381	CAPACITOR, FIXED, PAPER DIELECTRIC 118P10402S3 (56289)	EA	REF				*	*	*	*	*	3-31	1A5A6C26
P-H	5910-686-6929	CAPACITOR, FIXED, PAPER DIELECTRIC 118P33302S3 (56289)	EA	4				*	*	*	*	*	3-31	1A5A6C3
P-H	5910-586-6929	CAPACITOR, FIXED, PAPER DIELECTRIC 118P33302S3 (56289)	EA	REF				*	*	*	*	*	3-31	1A5A6C9
P-H	5910-686-6929	CAPACITOR, FIXED, PAPER DIELECTRIC 118P33302S3 (56289)	EA	REF				*	*	*	*	*	3-31	1A5A6C12
P-H	5910-686-6929	CAPACITOR, FIXED, PAPER DIELECTRIC 118P33302S3 (56289)	EA	REF				*	*	*	*	*	3-31	1A5A6C25
X1-F		BRACKET, TOP 543-1491-002 (13499)	EA	1										
P-F	5310-584-129	NUT, SELF-LOCKING CLINCH 68NG1-40 (72962)	EA	REF	*	*	*	*	*	*	*	*		
X2-F		JACK, TIP SKT41WHT (98291)	EA	2									3-31	1A5A6J1
X2-F		JACK, TIP SKT41WHT (98291)	EA	REF									3-31	1A5A6J2
X2-F		BRACKET, TOP 543-1492-003 (13499)	EA	REF										
X2-F		CASTING-BASE PLATE 543-1493-002 (13499)	EA	1										
P-H		PIN-LOCATING 540-7766-002 (13499)	EA	REF				*	*	*	*	*		
X2-F		CASTING-BASE PLATE 543-1496-004 (13499)	EA	1										
X2-F		PLATE, BASE 543-1494-014 (13499)	EA	REF										

SECTION III REPAIR PARTS FOR DIRECT SUPPORT, GENERAL SUPPORT, AND DEPOT MAINTENANCE (CONTINUED)

(1) SIR CODE	(2) FEDERAL STOCK NUMBER	(3) DESCRIPTION  REFERENCE NUMBER & MFR. CODE	(4) UNIT OF MEAS	(5) QTY INC IN UNIT	(6) 30-DAY DS MAINT ALLOWANCE			(7) 30-DAY GS MAINT ALLOWANCE			(8) 1 YR ALW PER EQUIP CWTGCT	(9) DEPOT MAINT ALW PER 100 EQUIP	(10) ILLUSTRATIONS	
					(a)	(b)	(c)	(a)	(b)	(c)			(a)	(b)
					1-20	21-50	51-100	1-20	21-50	51-100			FIG NO.	ITEM NO. OR REFERENCE DESIGNATION
X2-F		FRAME, CHASSIS 543-1498-002 (13499)	EA	1										
X2-F	5320-117-6010	RIVET, SOLID MS20426AD2-3 (96906)	EA	REF										
X2-F		FRAME, CHASSIS 543-1506-004 (13499)	EA	1										
P-H		BRACKET, RETAINING 542-7768-002 (13499)	EA	REF				*	*	*	*	*		
A-F		PLATE, CHASSIS 543-1507-003 (13499)	EA	1										
P-F	5950-583-0919	TRANSFORMER, INTERMEDIATE FREQUENCY XD71-1 (81815)	EA	2	*	*	*	*	*	*	*	*	3-31	1A5A6T1
P-F	5950-583-0919	TRANSFORMER, INTERMEDIATE FREQUENCY XD71-1 (81815)	EA	REF	*	*	*	*	*	*	*	*	3-31	1A5A6T2
P-F	5950-583-0918	TRANSFORMER, INTERMEDIATE FREQUENCY XD72-1 (81815)	EA	1	*	*	*	*	*	*	*	*	3-31	1A5A6T5
P-F	5950-583-0950	COIL, RADIO FREQUENCY 41-542 (06978)	EA	1	*	*	*	*	*	*	*	*	3-31	1A5A6L1
X2-F		PLATE, CHASSIS 543-1508-004 (13499)	EA	1										
X2-F		RIVET, TUBULAR R348X3-32CADPL (12014)	EA	REF										
P-H	5340-951-4572	RETAINER, ELECTRIC 100-200-16-5 (99378)	EA	REF				*	*	*	*	*		
P-F	5940-782-8942	TERMINAL, FEEDTHRU PTSM1 (98291)	EA	REF	*	*	*	*	*	*	*	*		
P-F		TERMINAL, STUD 2619A (12615)	EA	REF	*	*	*	*	*	*	*	*		
X1-F		EYELET, METALLIC SE33CADPL (90030)	EA	REF										
X1-F		EYELET, METALLIC S43BOTTINNED (61957)	EA	REF										
P-F	5310-584-8129	NUT, SELF-LOCKING CLINCH 68NC1-40 (72962)	EA	REF	*	*	*	*	*	*	*	*		
P-F		BRACKET, TRANSISTOR 543-1512-002 (13499)	EA	REF	*	*	*	*	*	*	*	*		
P-F		BRACKET, TRANSISTOR 10-21-120-017 (96214)	EA	REF	*	*	*	*	*	*	*	*		
X1-F		BRACKET, RESISTOR, MOUNTING 543-1513-002 (13499)	EA	REF										
X1-F		BRACKET, SHIELD 543-1520-002 (13499)	EA	REF										
X2-F		BRACKET-COIL 543-1511-003 (13499)	EA	REF										
X2-F		PLATE, CHASSIS 543-1510-005 (13499)	EA	1										
P-H		RETAINER, FILTER 543-1517-032 (13499)	EA	REF				*	*	*	*	*		
P-H		SCREW, SHOULDERED 542-7683-002 (13499)	EA	REF				*	*	*	*	*		
X2-H		PLATE, COVER 542-7696-003 (13499)	EA	REF										
P-H	5905-192-3987	RESISTOR, FIXED, COMPOSITION RC20GF104K (81349)	EA	1				*	*	*	*	*	3-31	1A5A6R23

SECTION III REPAIR PARTS FOR DIRECT SUPPORT, GENERAL SUPPORT, AND DEPOT MAINTENANCE (CONTINUED)

(1) 348 CODE	(2) FEDERAL STOCK NUMBER	(3) DESCRIPTION  USABLE ON CODE	(4) UNIT OF MEAS	(5) QTY INC IN UNIT	(6) 30-DAY DS MAINT ALLOWANCE			(7) 30-DAY GS MAINT ALLOWANCE			(8) 1 YR ALW PER EQUIP CHTGCY	(9) DEPOT MAINT ALW PER 100 EQUIP	(10) ILLUSTRATIONS	
					(a)	(b)	(c)	(a)	(b)	(c)			(a)	(b)
					1-20	21-50	51-100	1-20	21-50	51-100			FIG NO.	ITEM NO. OR REFERENCE DESIGNATION
M-R		INSULATION SLEEVING, ELECTRICAL TEFTW16B (81851)	FT	REF										
M-R		INSULATION SLEEVING, ELECTRICAL TEFTW20B (81851)	FT	REF										
P-R	5905-279-2658	RESISTOR, FIXED, COMPOSITION RC20GF820K (81349)	EA	1				*	*	*	*		3-31	1A5A6R6
P-F	5905-195-6806	RESISTOR, FIXED, COMPOSITION RC20GF102K (81349)	EA	1	*	*	*	*	*	*	*		3-32	1A5A6R1
P-F	5910-939-7510	CAPACITOR, FIXED, CERAMIC DIELECTRIC CCL15AX223M (81349)	EA	2	*	*	*	*	*	*	*			1A5A6C28
P-F	5910-939-7510	CAPACITOR, FIXED, CERAMIC DIELECTRIC CCL15AX223M (81349)	EA	REF	*	*	*	*	*	*	*			1A5A6C30
P-F	5910-542-7387	CAPACITOR, FIXED, ELECTROLYTIC 150D475X0035B2 (56289)	EA	1	*	*	*	*	*	*	*			1A5A6C29
P-R	5905-106-9348	RESISTOR, SELECT FROM RESISTOR, FIXED, COMPOSITION RC20GF154K (81349)	EA	1				*	*	*	*			1A5A6R32
P-R	5905-192-0662	RESISTOR, FIXED, COMPOSITION RC20GF184K (81349)	EA	1				*	*	*	*			1A5A6R32
P-R	5905-279-1756	RESISTOR, SELECT FROM RESISTOR, FIXED, COMPOSITION RC20GF151K (81349)	EA	1				*	*	*	*		3-31	1A5A6R30
P-F	5905-256-0410	RESISTOR, FIXED, COMPOSITION RC20GF181K (81349)	EA	1	*	*	*	*	*	*	*		3-31	1A5A6R30
P-R	5905-256-0409	RESISTOR, FIXED, COMPOSITION RC20GF221K (81349)	EA	1				*	*	*	*		3-31	1A5A6R30
P-F	5905-185-6966	RESISTOR, FIXED, COMPOSITION RC20GF271K (81349)	EA	1	*	*	*	*	*	*	*		3-31	1A5A6R30
P-F	5905-171-1997	RESISTOR, FIXED, COMPOSITION RC20GF311K (81349)	EA	1	*	*	*	*	*	*	*		3-31	1A5A6R30
P-F	5905-111-4742	RESISTOR, FIXED, COMPOSITION RC20GF391K (81349)	EA	1	*	*	*	*	*	*	*		3-31	1A5A6R30
P-R	5905-171-2005	RESISTOR, FIXED, COMPOSITION RC20GF471K (81349)	EA	1				*	*	*	*		3-31	1A5A6R30
P-R	5905-942-9326	RESISTOR, FIXED, COMPOSITION RC20GF561K (81349)	EA	1				*	*	*	*		3-31	1A5A6R30
P-R	5905-256-0387	RESISTOR, FIXED, COMPOSITION RC20GF681K (81349)	EA	1				*	*	*	*		3-31	1A5A6R30
		GROUP 03 - POWER SUPPLY PP-2154/U												
A-O-R		POWER SUPPLY, LOW VOLTAGE PP-2154/U 522-0862-003 (13499)	EA	1									3-1	1A10
M-D		PLATE, IDENTIFICATION 280-1254-000 (12998)	EA	REF										
M-D		PLATE, IDENTIFICATION 546-7995-002 (13499)	EA	1										
P-F	5310-011-1041	WASHER, LOCK MS35338-79 (96906)	EA	REF	*	*	*	*	*	*	*			
P-F		WASHER, LOCK 310-6360-000 (79.7)	EA	REF	*	*	*	*	*	*	*			
P-F		SCREW, TAPPING THREAD 2XL-8PANHDTPBCADPL (45722)	EA	REF	*	*	*	*	*	*	*			
P-F	5310-857-5547	NUT, SELF-LOCKING, HEXAGON MS21044D06 (96906)	EA	REF	*	*	*	*	*	*	*			

TM 11-5820-555-24P  
SECTION III REPAIR PARTS FOR DIRECT SUPPORT, GENERAL SUPPORT, AND DEPOT MAINTENANCE (CONTINUED)

(1) S/R CODE	(2) FEDERAL STOCK NUMBER	(3) DESCRIPTION  REFERENCE NUMBER & MFR. CODE	(4) UNIT OF MEAS	(5) QTY INC IN UNIT	(6) 30-DAY DS MAINT ALLOWANCE			(7) 30-DAY GS MAINT ALLOWANCE			(8) 1 YR ALM PER EQUIP CNTCY	(9) DEPOT MAINT ALM PER 100 EQUIP	(10) ILLUSTRATIONS	
					(a) 1-20	(b) 21-50	(c) 51-100	(a) 1-20	(b) 21-50	(c) 51-100			(a) FIG NO.	(b) ITEM NO. OR REFERENCE DESIGNATION
P-F	5305-054-5635	SCREW, MACHINE MS51957-1 (96906)	EA	REF	*	*	*	*	*	*	*			
P-F	5305-054-6654	SCREW, MACHINE MS51957-30 (96906)	EA	REF	*	*	*	*	*	*	*			
P-F	5305-054-6653	SCREW, MACHINE MS51957-29 (96906)	EA	REF	*	*	*	*	*	*	*			
P-F	5310-275-1347	WASHER, FLAT 310-0046-000 (79807)	EA	REF	*	*	*	*	*	*	*			
X2-F		FRAME ASSEMBLY 540-6335-004 (13499)	EA	1										
P-F		SETScrew 10-32X5-86SPLINE416SST (08664)	EA	REF	*	*	*	*	*	*	*			
P-F	5305-765-4346	SCREW, MACHINE MS51959-35 (96906)	EA	REF	*	*	*	*	*	*	*			
P-F	5305-765-4257	SCREW, MACHINE MS51959-43 (96906)	EA	REF	*	*	*	*	*	*	*			
P-F	5305-054-6650	SCREW, MACHINE MS51957-26 (96906)	EA	REF	*	*	*	*	*	*	*			
P-F	5305-579-3513	SCREW, MACHINE MS35217-22 (96906)	EA	REF	*	*	*	*	*	*	*			
P-F	5310-209-1366	WASHER, LOCK MS35335-58 (96906)	EA	REF	*	*	*	*	*	*	*			
P-F	5310-054-1831	WASHER, LOCK MS35338-81 (96906)	EA	REF	*	*	*	*	*	*	*			
P-F		POST, STANDOFF 561-2189-002 (13499)	EA	REF	*	*	*	*	*	*	*			
P-F	5315-791-7836	SCREW, EXTERNALLY RELIEVED 540-6241-002 (13499)	EA	REF	*	*	*	*	*	*	*			
X1-F		BLOCK, SPACER 540-6243-002 (13499)	EA	REF										
X2-F		PLATE, HINGE 540-6240-002 (13499)	EA	REF										
X2-F		PLATE, PIVOT 540-6242-002 (13499)	EA	REF										
P-F	5340-634-7444	RING, RETAINING MS16632-1018 (96906)	EA	REF	*	*	*	*	*	*	*			
X1-F		BUMPER, CHASSIS 561-2374-003 (13499)	EA	2										
X2-F		PLATE, HINGE 540-6259-002 (13499)	EA	1										
X1-F		PIN, GROOVED 541-3627-002 (13499)	EA	REF										
X2-F		PLATE, HINGE 540-6235-002 (13499)	EA	1										
X2-F		BLOCK, CENTER 540-6374-003 (13499)	EA	1										
P-H		NUT, PLAIN, ROUND 540-6244-002 (13499)	EA	REF				*	*	*	*	*		
X2-F		BLOCK, CENTER 540-6253-003 (13499)	EA	1										
X2-F		FRAME-STAKED 540-6329-004 (13499)	EA	1										
P-H		NUT, ROUND, PLAIN 540-6244-002 (13499)	EA	REF				*	*	*	*	*		

SECTION III REPAIR PARTS FOR DIRECT SUPPORT, GENERAL SUPPORT, AND DEPOT MAINTENANCE (CONTINUED)

(1) SIB CODE	(2) FEDERAL STOCK NUMBER	(3) DESCRIPTION  REFERENCE NUMBER & MFR. CODE	(4) UNIT OF MEAS	(5) QTY INC IN UNIT	(6) 30-DAY DS MAINT ALLOWANCE			(7) 30-DAY GS MAINT ALLOWANCE			(8) 1 YR ALW PER EQUIP CNTGCTY	(9) DEPOT MAINT ALW PER 100 EQUIP	(10) ILLUSTRATIONS	
					(a) 1-20	(b) 21-50	(c) 51-100	(a) 1-20	(b) 21-50	(c) 51-100			(a) FIG NO.	(b) ITEM NO. OR REFERENCE DESIGNATION
X2-F		FRAME 540-6317-004 (13499)	EA	1										
X1-F		CHANNEL, CHASSIS 540-6300-004 (13499)	EA	REF										
X1-F		CHANNEL, CHASSIS 540-6301-004 (13499)	EA	REF										
X2-F		BRACKET, END 540-6246-003 (13499)	EA	1										
X2-F		PLATE, SPACER 540-6264-003 (13499)	EA	2										
X1-F		PLATE, SLIDING 542-3236-002 (13499)	EA	REF										
X2-F		COVER, POWER SUPPLY 542-7401-004 (13499)	EA	1										
A-F		COVER, POWER SUPPLY 542-7404-005 (13499)	EA	1										
X1-F		COVER, POWER SUPPLY 542-7403-005 (13499)	EA	1										
X1-F		LATCH, RIM H4600-040-250 (83014)	EA	REF										
X2-F		RIVET, TUBULAR R4008X1-8CHROMATEDP (12014)	EA	REF										
A-O		PANEL, POWER DISTRIBUTOR 542-7405-005 (13499)	EA	1										
P-F	5910-542-7366	CAPACITOR, FIXED, ELECTROLYTIC D28452 (56289)	EA	1	*	*	*	*	*	*	*	*	3-34	1A10C6
P-H		CORD, NYLON 435-1014-000 (13499)	FT	REF										
P-F	5950-679-9503	REACTOR 26582 (80089)	EA	1	*	*	*	*	*	*	*	*	3-34	1A10L3
P-F	5910-542-7365	CAPACITOR, FIXED, ELECTROLYTIC D27150 (56289)	EA	1	*	*	*	*	*	*	*	*	3-34	1A10C3
P-F	5910-044-4895	CAPACITOR, FIXED, ELECTROLYTIC UP9BJ39 (14655)	EA	2	*	*	*	*	*	*	*	*	3-34	1A10C1
P-F	5910-044-4895	CAPACITOR, FIXED, ELECTROLYTIC UP9BJ39 (14655)	EA	REF	*	*	*	*	*	*	*	*	3-34	1A10C2
P-F	5910-679-9502	CAPACITOR, FIXED, ELECTROLYTIC D27153 (56289)	EA	1	*	*	*	*	*	*	*	*	3-34	1A10C5
P-F	5950-679-9504	TRANSFORMER, POWER E10265A (80008)	EA	1	*	*	*	*	*	*	*	*	3-33	1A10T1
X1-F		POST, MOUNTING, RESISTOR P015-0552-000 (77250)	EA	1										
P-F	5325-276-4221	GROMMET, RUBBER 911 (75543)	EA	REF	*	*	*	*	*	*	*	*		
P-O	6240-155-8706	LAMP, INCANDESCENT M515571-2 (96906)	EA	1	*	*	*	*	*	*	*	*	3-33	1A10I1
P-O	6210-067-8381	LIGHT, INDICATOR 81410-1PC (72619)	EA	1	*	*	*	*	*	*	*	*	3-33	1A10XI1
P-O	6210-583-9437	LENS, INDICATOR LIGHT 25-100RED (72765)	EA	1	*	*	*	*	*	*	*	*	3-33	1A10DS1
P-O	5920-518-1793	FUSE, CARTRIDGE F02A250V3AS (81249)	EA	1	*	*	*	*	*	*	*	*	3-33	1A10F1
P-F	5920-655-4133	FUSEHOLDER HKLJRWZZ (71400)	EA	1	*	*	*	*	*	*	*	*	3-33	1A10XF1

TM 11-5820-555-24P  
SECTION III REPAIR PARTS FOR DIRECT SUPPORT, GENERAL SUPPORT, AND DEPOT MAINTENANCE (CONTINUED)

(1) SMR CODE	(2) FEDERAL STOCK NUMBER	(3) DESCRIPTION  REFERENCE NUMBER & MFR. CODE	(4) UNIT OF MEAS	(5) QTY INC IN UNIT	(6) 30-DAY DS MAINT ALLOWANCE			(7) 30-DAY GS MAINT ALLOWANCE			(8) 1 YR ALW PER EQUIP CNTQCY	(9) DEPOT MAINT ALW PER 100 EQUIP	(10) ILLUSTRATIONS	
					(a) 1-20	(b) 21-50	(c) 51-100	(a) 1-20	(b) 21-50	(c) 51-100			(a) FIG NO.	(b) ITEM NO. OR REFERENCE DESIGNATION
P-F	5930-655-1582	SWITCH, TOGGLE MS35059-23 (96906)	EA	1	*	*	*	*	*	*	*	*	3-33	1A10S1
P-F		WASHER, FLAT 310-0447-000 (79807)	EA	1	*	*	*	*	*	*	*	*		
P-F	5310-011-1041	WASHER, LOCK MS35338-79 (96906)	EA	REF	*	*	*	*	*	*	*	*		
P-F		WASHER, LOCK 1722-01CADPLATED (78189)	EA	REF	*	*	*	*	*	*	*	*		
P-F		NUT, PLAIN, HEXAGON P313-0053-000 (77250)	EA	REF	*	*	*	*	*	*	*	*		
P-F		NUT, PLAIN, HEXAGON P313-0045-000 (77250)	EA	REF	*	*	*	*	*	*	*	*		
P-F	5310-271-4645	NUT, PLAIN, HEXAGON MS35-649-84 (96906)	EA	8	*	*	*	*	*	*	*	*		
P-F	5305-059-8475	SCREW, MACHINE MS35216-41 (96906)	EA	11	*	*	*	*	*	*	*	*		
P-F	5305-770-2533	SCREW, MACHINE MS51957-13 (96906)	EA	REF	*	*	*	*	*	*	*	*		
P-F	5305-054-6653	SCREW, MACHINE MS51957-27 (96906)	EA	REF	*	*	*	*	*	*	*	*		
P-F		INSULATOR, WASHER 302-0348-000 (91500)	EA	10	*	*	*	*	*	*	*	*		
P-F	5305-054-5648	SCREW, MACHINE MS51957-14 (96906)	EA	REF	*	*	*	*	*	*	*	*		
P-F	5305-054-6654	SCREW, MACHINE MS51957-30 (96906)	EA	REF	*	*	*	*	*	*	*	*		
P-O	5310-054-1830	WASHER, LOCK MS35338-80 (96906)	EA	REF	*	*	*	*	*	*	*	*		
P-F	5310-209-1366	WASHER, LOCK MS35335-58 (96906)	EA	REF	*	*	*	*	*	*	*	*		
P-F	5310-042-9609	WASHER, LOCK MS35338-78 (96906)	EA	REF	*	*	*	*	*	*	*	*		
P-F		POST, SPACING 540-9180-003 (13499)	EA	4	*	*	*	*	*	*	*	*		
P-F		POST, SPACING 541-0162-002 (13499)	EA	4	*	*	*	*	*	*	*	*		
X2-F		PLATE, FRONT 542-7400-004 (13499)	EA	1	*	*	*	*	*	*	*	*		
X2-F		PLATE, CONTROL 542-7396-003 (13499)	EA	1	*	*	*	*	*	*	*	*		
X2-F		PLATE, ADAPTER 544-2709-003 (13499)	EA	1	*	*	*	*	*	*	*	*		1A10TB3
P-F		NUT, CAPTIVE N0N6-2-2-1 (07886)	EA	REF	*	*	*	*	*	*	*	*		
X2-F		PLATE, ADAPTER 544-2708-003 (13499)	EA	1	*	*	*	*	*	*	*	*		
X2-F		SHIELD, FUSE 542-7407-003 (13499)	EA	1	*	*	*	*	*	*	*	*		
A-F		BOARD ASSEMBLY 542-7392-002 (13499)	EA	1	*	*	*	*	*	*	*	*		
P-F	5961-688-6316	SEMICONDUCTOR DEVICE, DIODE 1N1095 (07688)	EA	3	*	*	*	*	*	*	*	*	3-34	1A10CR1
P-F	5961-688-6316	SEMICONDUCTOR DEVICE, DIODE 1N1095 (07688)	EA	REF	*	*	*	*	*	*	*	*	3-34	1A10CR5



SECTION III REPAIR PARTS FOR DIRECT SUPPORT, GENERAL SUPPORT, AND DEPOT MAINTENANCE (CONTINUED)

(1) SIR CODE	(2) FEDERAL STOCK NUMBER	(3) DESCRIPTION  REFERENCE NUMBER & MFR. CODE	(4) UNIT OF MEAS	(5) QTY INC IN UNIT	(6) 30-DAY DS MAINT ALLOWANCE			(7) 30-DAY GS MAINT ALLOWANCE			(8) YR ALW PER EQUIP CHNGCY	(9) DEPOT MAINT ALW PER 100 EQUIP	(10) ILLUSTRATIONS	
					(a) 1-20	(b) 21-50	(c) 51-100	(a) 1-20	(b) 21-50	(c) 51-100			(a) FIG NO.	(b) ITEM NO. OR REFERENCE DESIGNATION
P-F	5961-688-6316	SEMICONDUCTOR DEVICE, DIODE 1N1095 (07688)	EA	REF	*	*	*	*	*	*	*	*	3-34	1A10CR8
P-F	5961-735-1433	SEMICONDUCTOR DEVICE, DIODE 1N1086A (07688)	EA	2	*	*	*	*	*	*	*	*	3-34	1A10CR6
P-F	5961-735-1433	SEMICONDUCTOR DEVICE, DIODE 1N1086A (07688)	EA	REF	*	*	*	*	*	*	*	*	3-34	1A10CR7
P-F	5820-811-9814	BOARD-RECTIFIER 542-7388-002 (13499)	EA	1	*	*	*	*	*	*	*	*	3-34	1A10TB2
P-H	5940-917-3884	CLIP, ELECTRICAL 5678-02 (71400)	EA	4	*	*	*	*	*	*	*	*		
XI-F		RIVET, TUBULAR R3472X7-32CADFL (12014)	EA	4	*	*	*	*	*	*	*	*		
XI-F		BOARD-RECTIFIER 542-7387-002 (13499)	EA	1	*	*	*	*	*	*	*	*		
XI-F		TERMINAL, FEEDTHRU CF1044-4-309 (71279)	EA	16	*	*	*	*	*	*	*	*		
X2-F		BRACKET, ANGLE 756-2252-002 (13499)	EA	2	*	*	*	*	*	*	*	*		
M-H		WIRE, ELECTRICAL 00702-1320 (70567)	FT	REF										
A-F		RESISTOR ASSEMBLY 542-7393-002 (13499)	EA	1	*	*	*	*	*	*	*	*		
P-F	5905-279-2643	RESISTOR, FIXED, COMPOSITION RC32GF101K (81349)	EA	1	*	*	*	*	*	*	*	*	3-34	1A10R5
P-F	5905-279-1976	RESISTOR, FIXED, COMPOSITION RC42GF101K (81349)	EA	1	*	*	*	*	*	*	*	*	3-34	1A10R2
P-F	5905-254-7101	RESISTOR, FIXED, COMPOSITION RC42GF104K (81349)	EA	1	*	*	*	*	*	*	*	*	3-34	1A10R3
P-F	5905-195-6502	RESISTOR, FIXED, COMPOSITION RC42GF333K (81349)	EA	1	*	*	*	*	*	*	*	*	3-34	1A10R4
P-F	5905-279-2303	RESISTOR, FIXED, COMPOSITION RC42GF562K (81349)	EA	1	*	*	*	*	*	*	*	*	3-34	1A10R6
P-F	5905-192-0626	RESISTOR, FIXED, COMPOSITION RC42GF123K (81349)	EA	1	*	*	*	*	*	*	*	*	3-34	1A10R7
P-F	5905-299-2027	RESISTOR, FIXED, COMPOSITION RC32GF123K (81349)	EA	1	*	*	*	*	*	*	*	*	3-34	1A10R8
P-H	5820-811-7678	TERMINAL BOARD 542-7386-002 (13499)	EA	1	*	*	*	*	*	*	*	*	3-34	1A10TB1
P-H		TERMINAL, STUD 1143C (71279)	EA	14	*	*	*	*	*	*	*	*		
XI-F		TERMINAL BOARD 542-7385-002 (13499)	EA	1	*	*	*	*	*	*	*	*		
P-F	5950-645-5866	REACTOR A8482 (70674)	EA	1	*	*	*	*	*	*	*	*	3-34	1A10I2
P-F	5950-647-7136	REACTOR 67867 (73831)	EA	1	*	*	*	*	*	*	*	*	3-34	1A10I1
P-F	5905-882-3028	RESISTOR, FIXED, WIRE WOUND RW30V8R2 (81349)	EA	1	*	*	*	*	*	*	*	*	3-34	1A10R1
M-H		WIRE, ELECTRICAL MILW16878TYPE22-9 (81349)	FT	REF										
M-H		WIRE, ELECTRICAL 00702-1322 (70567)	FT	REF										
M-H		CABLE ASSEMBLY 542-7384-000 (13499)	EA	1	*	*	*	*	*	*	*	*		
M-H		WIRE, ELECTRICAL MILW16878TYPE22-913 (81349)	FT	REF										

SECTION III REPAIR PARTS FOR DIRECT SUPPORT, GENERAL SUPPORT, AND DEPOT MAINTENANCE (CONTINUED)

(1) SFC CODE	(2) FEDERAL STOCK NUMBER	(3) DESCRIPTION  REFERENCE NUMBER & MFR. CODE	USABLE ON CODE	(4) UNIT OF MEAS	(5) QTY INC IN UNIT	(6) 30-DAY DS MAINT ALLOWANCE			(7) 30-DAY GS MAINT ALLOWANCE			(8) 1 YR ALW PER EQUIP CWTGCT	(9) DEPOT MAINT ALW PER 100 EQUIP	(10) ILLUSTRATIONS		
						(a)	(b)	(c)	(a)	(b)	(c)			(11) FIG NO.	(12) ITEM NO. OR REFERENCE DESIGNATION	
						1-20	21-50	51-100	1-20	21-50	51-100					
M-H		WIRE, ELECTRICAL MILW16878TYPEB22-915 (81349)		FT	REF											
M-H		WIRE, ELECTRICAL MILW16878TYPEB22-912 (81349)		FT	REF											
M-H		WIRE, ELECTRICAL MILW16878TYPEB22-9 (81349)		FT	REF											
M-H		WIRE, ELECTRICAL MILW16878TYPEB22-91 (81349)		FT	REF											
M-H		WIRE, ELECTRICAL MILW16878TYPEB22-92 (81349)		FT	REF											
M-H		WIRE, ELECTRICAL MILW16878TYPEB22-93 (81349)		FT	REF											
M-H		WIRE, ELECTRICAL MILW16878TYPEB22-95 (81349)		FT	REF											
M-H		WIRE, ELECTRICAL MILW16878TYPEB22-96 (81349)		FT	REF											
M-H		WIRE, ELECTRICAL MILW16878TYPEB22-902 (81349)		FT	REF											
M-H		WIRE, ELECTRICAL MILW16878TYPEB22-903 (81349)		FT	REF											
M-H		WIRE, ELECTRICAL MILW16878TYPEB22-905 (81349)		FT	REF											
M-H		WIRE, ELECTRICAL MILW16878TYPEB22-906 (81349)		FT	REF											
M-H		WIRE, ELECTRICAL MILW16878TYPEB22-916 (81349)		FT	REF											
M-H		WIRE, ELECTRICAL MILW16878TYPEB22-923 (81349)		FT	REF											
M-H		WIRE, ELECTRICAL MILW16878TYPEB22-925 (81349)		FT	REF											
M-H		WIRE, ELECTRICAL MILW16878TYPEB22-926 (81349)		FT	REF											
M-H		WIRE, ELECTRICAL MILW16878TYPEB22-936 (81349)		FT	REF											
P-H		WIRE, ELECTRICAL MILW16878TYPEB22-956 (81349)	( 8 1 3 4 9 )	FT	REF				*	*	*	*	*			
M-H		WIRE, ELECTRICAL MILW16878TYPEB22-912-3 (81349)		FT	REF											
M-H		WIRE, ELECTRICAL MILW16878TYPEB22-935 (81349)		FT	REF											
M-H		WIRE, ELECTRICAL MILW16878TYPEB22-902-3 (81349)		FT	REF											
M-H		WIRE, ELECTRICAL MILW16878TYPEB22-902-5 (81349)		FT	REF											
M-H		WIRE, ELECTRICAL MILW16878TYPEB22-902-6 (81349)		FT	REF											
P-H		WIRE, ELECTRICAL MILW16878TYPEB22-9125 (81349)		FT	REF				*	*	*	*	*			
P-H		CORD, NYLON 435-1014-000 (13499)		FT	REF				*	*	*	*	*			
P-H		WIRE, ELECTRICAL MILW16878TYPEB22-9126 (81349)		FT	REF				*	*	*	*	*			
P-H		WIRE, ELECTRICAL MILW16878TYPEB22-9235 (81349)		FT	REF				*	*	*	*	*			

SECTION III REPAIR PARTS FOR DIRECT SUPPORT, GENERAL SUPPORT, AND DEPOT MAINTENANCE (CONTINUED)

(1) SQR CODE	(2) FEDERAL STOCK NUMBER	(3) DESCRIPTION  REFERENCE NUMBER & MFR. CODE	(4) UNIT OF MEAS	(5) QTY INC IN UNIT	(6) 30-DAY DS MAINT ALLOWANCE			(7) 30-DAY GS MAINT ALLOWANCE			(8) 1 YR ALW PER EQUIP CNTGCT	(9) DEPOT MAINT ALW PER 100 EQUIP	(10) ILLUSTRATIONS	
					(a)	(b)	(c)	(a)	(b)	(c)			(a)	(b)
					1-20	21-50	51-100	1-20	21-50	51-100			FIG NO.	ITEM NO. OR REFERENCE DESIGNATION
P-H		WIRE, ELECTRICAL MILW16878TYPEB22-9236 (81349)	FT	REF				*	*	*	*			
M-H		WIRE, ELECTRICAL BUC726N90 (90484)	FT	3										
M-H		WIRE, ELECTRICAL BUC726N91 (90484)	FT	3										
M-H		WIRE, ELECTRICAL MILW16878TYPEB22-902 (81349)	FT	REF										
M-H		INSULATION SLEEVING, ELECTRICAL MIL13190CIBALSIZES8-0 (81349)	FT	1										
M-H		INSULATION SLEEVING, ELECTRICAL MIL13190CIBALSIZES10-0 (81349)	FT	1										
P-F	5310-167-0847	WASHER, LOCK AN936B6B (88044)	EA	REF	*	*	*	*	*	*	*	*		
M-H		TERMINAL, LUG 505-5038-001 (13499)	EA	1										
P-H		TERMINAL, LUG 2102-06-00-2520N (78189)	EA	1				*	*	*	*	*		
P-F		SCREW, MACHIN. P343-0329-000 (77250)	EA	REF	*	*	*	*	*	*	*	*		
P-F	5325-174-5317	GROMMET, RUBBER MS35489-4 (96906)	EA	1	*	*	*	*	*	*	*	*		
P-F		SCREW, MACHINE P342-0026-000 (77250)	EA	4	*	*	*	*	*	*	*	*		
M-H		INSULATION SLEEVING, ELECTRICAL 152-1743-000 (13499)	FT	REF										
P-F	5961-892-0620	SEMICONDUCTOR DEVICE, DIODE 1N1361A (07688)	EA	1	*	*	*	*	*	*	*	*	3-34	1A10C9
P-F	5910-542-7368	CAPACITOR, FIXED, ELECTROLYTIC D28437 (56289)	EA	1	*	*	*	*	*	*	*	*	3-34	1A10C4
P-F	5905-837-7837	RESISTOR, FIXED, WIRE WOUND HLL131-5PCT (91637)	EA	2	*	*	*	*	*	*	*	*	3-34	1A10B9
P-F	5905-837-7837	RESISTOR, FIXED, WIRE WOUND HLL131-5PCT (91637)	EA	REF	*	*	*	*	*	*	*	*	3-34	1A10B10
P-H		POST, MOUNTING, RESISTOR POL5-0558-000 (77250)	EA	3				*	*	*	*	*		
P-F	5310-058-3599	WASHER, LOCK MS35335-57 (96906)	EA	REF	*	*	*	*	*	*	*	*		
P-H	5970-705-9527	INSULATOR, WASHER 302-0347-000 (91500)	EA	6				*	*	*	*	*		
P-H		WASHER 504-0730-003 (13499)	EA	2				*	*	*	*	*		
P-F	5305-054-5649	SCREW, MACHINE MS51957-15 (96906)	EA	REF	*	*	*	*	*	*	*	*		
P-H	5310-209-1239	WASHER, LOCK MS35335-60 (96906)	EA	1				*	*	*	*	*		
P-H		NUT, PLAIN, HEXAGON P313-0056-000 (77250)	EA	6				*	*	*	*	*		
P-F	5935-504-3161	CONNECTOR, RECEPTACLE, ELECTRICAL 26-4402-16S (02660)	EA	1	*	*	*	*	*	*	*	*	3-34	1A10J1
P-F	5935-518-7419	CONNECTOR, RECEPTACLE, ELECTRICAL 26-4404-16S (02660)	EA	1	*	*	*	*	*	*	*	*	3-34	1A10J2
P-F	5310-331-2892	NUT, PLAIN, HEXAGON MS35649-44 (96906)	EA	REF	*	*	*	*	*	*	*	*		

SECTION III REPAIR PARTS FOR DIRECT SUPPORT, GENERAL SUPPORT, AND DEPOT MAINTENANCE (CONTINUED)

(1) S/R CODE	(2) FEDERAL STOCK NUMBER	(3) DESCRIPTION  REFERENCE NUMBER & MFR. CODE	(4) UNIT OF MEAS	(5) QTY INC IN UNIT	(6) 30-DAY DS MAINT ALLOWANCE			(7) 30-DAY GS MAINT ALLOWANCE			(8) 1 YR ALW PER EQUIP CNTGTY	(9) DEPOT MAINT ALW PER 100 EQUIP	(10) ILLUSTRATIONS	
					(a) 1-20	(b) 21-50	(c) 51-100	(a) 1-20	(b) 21-50	(c) 51-100			(a) FIG NO.	(b) ITEM NO. OR REFERENCE DESIGNATION
M-D		PLATE, IDENTIFICATION 280-0250-000 (72048)	EA	REF										
P-O		KIT, MOUNTING 024-0100-000 (13499)	EA	REF	*	*	*	*	*	*	*			
M-H		BAG, COTTON 024-0100-000 (13499)	EA	REF										
P-O	5310-054-1830	WASHER, LOCK MS35338-80 (96906)	EA	REF	*	*	*	*	*	*	*			
P-O		WASHER, FLAT 310-0167-000 (79807)	EA	REF	*	*	*	*	*	*	*			
P-O		WASHER, LOCK 310-0286-000 (13499)	EA	REF	*	*	*	*	*	*	*			
P-O	5305-579-3507	SCREW, MACHINE MS35216-40 (96906)	EA	REF	*	*	*	*	*	*	*			
P-O		SCREW, MACHINE P343-0247-00C (7250)	EA	REF	*	*	*	*	*	*	*			
P-H		CABLE ASSEMBLY 544-2582-002 (13499)	EA	1				*	*	*	*			
P-H		CABLE ASSEMBLY 544-2581-002 (13499)	EA	1				*	*	*	*			
		GROUP 04 - POWER SUPPLY PP-2153/U												
A-O-R		POWER SUPPLY PP-2153/U 522-0863-006 (13499)	EA	1								3-1	1A12	
P-F	5950-679-9511	TRANSFORMER, POWER 292-5648G1A (49956)	EA	1	*	*	*	*	*	*	*	3-35	1A12T1	
P-F	5950-679-9508	REACTOR 292-5660G1 (49956)	EA	1	*	*	*	*	*	*	*	3-35	1A12L1	
P-F	5950-820-1367	REACTOR 12103 (80089)	EA	1	*	*	*	*	*	*	*	3-35	1A12L2	
P-F	5910-816-0334	CAPACITOR, FIXED, PAPER DIELECTRIC 930-4340-000 (00656)	EA	2	*	*	*	*	*	*	*	3-35	1A12C1	
P-F	5910-816-0334	CAPACITOR, FIXED, PAPER DIELECTRIC 930-4340-000 (00656)	EA	REF	*	*	*	*	*	*	*	3-35	1A12C2	
P-F	5945-232-7665	RELAY, ARMATURE PR7AY (77342)	EA	1	*	*	*	*	*	*	*	3-35	1A12K1	
M-H		TERMINAL BOARD 60LY10M (75382)	EA	1								3-35	1A12TB1	
P-F	5935-284-3931	CONNECTOR, RECEPTACLE, ELECTRICAL UG931U (80058)	EA	1	*	*	*	*	*	*	*	3-35	1A12J1	
P-F	5905-679-9509	RESISTOR, FIXED, WIRE WOUND 2K40F22KPOR4-10PCT (44655)	EA	1	*	*	*	*	*	*	*	3-35	1A12R1	
P-F	5905-542-7666	RESISTOR, FIXED, WIRE WOUND RW35V183 (81349)	EA	3	*	*	*	*	*	*	*	3-35	1A12R2	
P-F	5905-542-7666	RESISTOR, FIXED, WIRE WOUND RW35V183 (81349)	EA	REF	*	*	*	*	*	*	*	3-35	1A12R3	
P-F	5905-542-7666	RESISTOR, FIXED, WIRE WOUND RW35V183 (81349)	EA	REF	*	*	*	*	*	*	*	3-35	1A12R4	
P-O	5920-636-0957	FUSE, CARTRIDGE F60C900VLA (81349)	EA	1	*	*	*	*	*	*	*	3-35	1A12F3	
M-D		PLATE, IDENTIFICATION 280-1254-000 (12988)	EA	REF										
M-D		PLATE, IDENTIFICATION 546-7994-002 (13499)	EA	1										

SECTION III REPAIR PARTS FOR DIRECT SUPPORT, GENERAL SUPPORT, AND DEPOT MAINTENANCE (CONTINUED)

(1) SIR CODE	(2) FEDERAL STOCK NUMBER	(3) DESCRIPTION  REFERENCE NUMBER & MFR. CODE	(4) UNIT OF MEAS	(5) QTY INC IN UNIT	(6) 30-DAY DS MAINT ALLOWANCE			(7) 30-DAY GS MAINT ALLOWANCE			(8) 1 YR ALM PER EQUIP CNTGCTY	(9) DEPOT MAINT ALW PER 100 EQUIP	(10) ILLUSTRATIONS	
					(a) 1-20	(b) 21-50	(c) 51-100	(a) 1-20	(b) 21-50	(c) 51-100			(a) FIG NO.	(b) ITEM NO. OR REFERENCE DESIGNATION
M-D		PLATE, INSTRUCTION 280-0464-000 (13499)	EA	3										
M-H		CLAMP, LOOP HP4N (09922)	EA	REF										
M-H		CLAMP, LOOP HP5N (09922)	EA	REF										
M-H		CLAMP, LOOP HP6N (09922)	EA	REF										
M-H		CLAMP, LOOP HP7N (09922)	EA	REF										
XL-H		RETAINER, CAPACITOR 49859 (00655)	EA	2										
XL-R		POST, MOUNTING PO15-0554-000 (77250)	EA	1										
XL-H		POST, MOUNTING PO15-0557-000 (77250,	EA	3										
P-H		INSULATOR CRLXB9 (71590)	EA	3				*	*	*	*	*		
P-H		INSULATOR STANDOFF NS9W0308 (81350)	EA	2				*	*	*	*	*		
XL-H		POST, SPACING 540-9460-003 (13499)	EA	2										
P-F	5940-151-4038	CLIP, ELECTRICAL 105001 (75915)	EA	2	*	*	*	*	*	*	*	*		
P-F		SCREW, TAPPING THREAD 2XL-8PANHDYFEBCADPL (45722)	EA	REF	*	*	*	*	*	*	*	*		
P-H	5305-054-5636	SCREW, MACHINE MS51957-2 (96906)	EA	REF	*	*	*	*	*	*	*	*		
P-F		SCREW, MACHINE P343-1567-000 (77250)	EA	4	*	*	*	*	*	*	*	*		
P-F		SCREW, MACHINE P343-0329-000 (77250)	EA	REF	*	*	*	*	*	*	*	*		
P-F	5305-054-6649	SCREW, MACHINE MS51957-25 (96906)	EA	18	*	*	*	*	*	*	*	*		
P-F	5305-054-6652	SCREW, MACHINE MS51957-28 (96906)	EA	REF	*	*	*	*	*	*	*	*		
P-F	5305-054-6653	SCREW, MACHINE MS51957-29 (96906)	EA	REF	*	*	*	*	*	*	*	*		
P-F	5310-060-2039	NUT, SELF-LOCKING, HEXAGON MS21044D08 (96906)	EA	2	*	*	*	*	*	*	*	*		
P-F	5305-054-6656	SCREW, MACHINE MS51957-32 (96906)	EA	4	*	*	*	*	*	*	*	*		
P-F	5305-059-8475	SCREW, MACHINE MS35216-41 (96906)	EA	REF	*	*	*	*	*	*	*	*		
P-F	5305-059-8478	SCREW, MACHINE MS35216-44 (96906)	EA	2	*	*	*	*	*	*	*	*		
P-F		SCREW, MACHINE P343-0345-000 (77250)	EA	2	*	*	*	*	*	*	*	*		
P-F	5305-059-8591	SCREW, MACHINE MS35217-53 (96906)	EA	6	*	*	*	*	*	*	*	*		
P-F	5305-059-8592	SCREW, MACHINE MS35217-54 (96906)	EA	2	*	*	*	*	*	*	*	*		

TM 11-5820-555-24P  
SECTION III REPAIR PARTS FOR DIRECT SUPPORT, GENERAL SUPPORT, AND DEPOT MAINTENANCE (CONTINUED)

(1) SNR CODE	(2) FEDERAL STOCK NUMBER	(3) DESCRIPTION  REFERENCE NUMBER & MFR. CODE	(4) UNIT OF MEAS	(5) QTY INC IN UNIT	(6) 30-DAY DS MAINT ALLOWANCE			(7) 30-DAY GS MAINT ALLOWANCE			(8) 1 YR ALW PER EQUIP ENTCY	(9) DEPOT MAINT ALW PER 100 EQUIP	(10) ILLUSTRATIONS	
					(a)	(b)	(c)	(a)	(b)	(c)			(a)	(b)
					1-20	21-50	51-100	1-20	21-50	51-100			FIG NO.	ITEM NO. OR REFERENCE DESIGNATION
P-F		SCREW, MACHINE P343-0247-000 (77250)	EA	1	*	*	*	*	*	*	*			
P-F	5305-071-1314	SCREW, MACHINE MS51957-78 (96906)	EA	4	*	*	*	*	*	*	*			
P-F	5305-727-8832	SCREW, MACHINE MS51959-29 (96906)	EA	39	*	*	*	*	*	*	*			
P-F	5305-764-0066	SCREW, MACHINE MS51959-44 (96906)	EA	5	*	*	*	*	*	*	*			
P-F	5310-877-5798	NUT, SELF-LOCKING, HEXAGON MS21044D3 (96906)	EA	16	*	*	*	*	*	*	*			
P-F	5305-059-7335	SCREW, MACHINE MS35201-56 (96906)	EA	8	*	*	*	*	*	*	*			
P-F		STUD, CONTINUOUS THREAD P312-3130-000 (77250)	EA	3	*	*	*	*	*	*	*			
P-F		WASHER, NONMETALLIC 302-0032-000 (05284)	EA	3	*	*	*	*	*	*	*			
P-F		WASHER, NONMETALLIC 302-0034-000 (05284)	EA	4	*	*	*	*	*	*	*			
P-F		WASHER, NONMETALLIC 302-0035-000 (05284)	EA	3	*	*	*	*	*	*	*			
P-F		INSULATOR, WASHER 6013 (44655)	EA	6	*	*	*	*	*	*	*			
P-F		INSULATOR, WASHER 302-0348-000 (91500)	EA	REF	*	*	*	*	*	*	*			
P-F		WASHER, FLAT 310-6360-000 (79807)	EA	REF	*	*	*	*	*	*	*			
P-F	5310-275-1347	WASHER, FLAT 310-6360-000 (79807)	EA	REF	*	*	*	*	*	*	*			
P-F		WASHER, FLAT 310-0447-000 (79807)	EA	REF	*	*	*	*	*	*	*			
P-F	5310-209-1074	WASHER, FLAT 310-0048-000 (79807)	EA	16	*	*	*	*	*	*	*			
P-F		WASHER, FLAT 310-0446-000 (79807)	EA	3	*	*	*	*	*	*	*			
P-F		WASHER, FLAT 310-0049-000 (79807)	EA	10	*	*	*	*	*	*	*			
P-F		WASHER, FLAT 310-0050-000 (79807)	EA	6	*	*	*	*	*	*	*			
P-F		WASHER, LOCK 310-0277-000 (13499)	EA	4	*	*	*	*	*	*	*			
P-F	5310-209-6069	WASHER, LOCK 310-0277-000 (79807)	EA	49	*	*	*	*	*	*	*			
P-F	5310-011-1641	WASHER, LOCK MS35338-79 (96906)	EA	REF	*	*	*	*	*	*	*			
P-F		WASHER, LOCK 310-0080-000 (79807)	EA	7	*	*	*	*	*	*	*			
P-F	5310-054-1831	WASHER, LOCK MS35338-81 (96906)	EA	REF	*	*	*	*	*	*	*			
P-F		WASHER, LOCK MS35338-82 (96906)	EA	22	*	*	*	*	*	*	*			
P-F		NUT, PLAIN, HEXAGON P313-0053-000 (96906)	EA	REF	*	*	*	*	*	*	*			
P-F		NUT, PLAIN, HEXAGON MS35699-64 (96906)	EA	REF	*	*	*	*	*	*	*			

SECTION III REPAIR PARTS FOR DIRECT SUPPORT, GENERAL SUPPORT, AND DEPOT MAINTENANCE (CONTINUED)

(1) SNR CODE	(2) FEDERAL STOCK NUMBER	(3) DESCRIPTION  REFERENCE NUMBER & MFR. CODE	USABLE ON CODE	(4) UNIT OF MEAS	(5) QTY INC IN UNIT	(6) 30-DAY DS MAINT ALLOWANCE			(7) 30-DAY GS MAINT ALLOWANCE			(8) 1 YR ALW PER EQUIP CNTGCTY	(9) DEPOT MAINT ALW PER 100 EQUIP	(10) ILLUSTRATIONS	
						(a) 1-20	(b) 21-50	(c) 51-100	(a) 1-20	(b) 21-50	(c) 51-100			(a) FIG NO.	(b) ITEM NO. OR REFERENCE DESIGNATION
P-O	5310-054-1830	WASHER, LOCK MS35338-20 (96906)		EA	REF	*	*	*	*	*	*	*	*		
P-F	5305-579-3513	SCREW, MACHINE MS35217-55 (96906)		EA	REF	*	*	*	*	*	*	*	*		
P-H		NUT, PLAIN, HEXAGON P313-0056-00 (77250)		EA	REF			*	*	*	*	*	*		
P-F		TERMINAL, LUG 12 (71785)		EA	2	*	*	*	*	*	*	*	*		
M-H		WIRE, ELECTRICAL OJ702-1318 (70567)		FT	5										
P-H		CORD-NYLON 435-1014-000 (13499)		FT	REF			*	*	*	*	*	*		
M-H		WIRE, ELECTRICAL OJ702-1316 (70567)		FT	7										
M-H		WIRE, ELECTRICAL M11W1697ETYPB22-90 (81349)		FT	REF										
M-H		TERMINAL, LUG MS25036-2 (96906)		EA	18										
M-H		TERMINAL, LUG 3189C (C0779)		EA	1										
X2-H		CHASSIS, ELECTRICAL EQUIPMENT 543-1474-005 (13499)		EA	1										
X2-H	5820-938-8294	COVER, POWER SUPPLY 543-1472-005 (13499)		EA	1										
X1-H		COVER 543-1471-005 (13499)		EA	1										
X1-H		LATCH, RIM H4600-040-250 (83014)		EA	REF										
X2-H		RIVET, TUBULAR R4008X1-8CHROMATEDP (12014)		EA	REF										
X2-H		RETAINER CAPACITOR 543-1442-002 (13499)		EA	2										
X2-H		DEFLECTOR, AIR 543-1447-002 (13499)		EA	1										
X2-H		COVER, TERMINAL ASSEMBLY 543-1453-002 (13499)		EA	1										
X2-H		COVER, TERMINAL 543-1444-002 (13499)		EA	1										
X1-H		PLATE, INSTRUCTION 280-0464-000 (13499)		EA	REF										
P-H	5305-054-5636	SCREW, MACHINE MS51957-2 (96906)		EA	REF			*	*	*	*	*	*		
P-F	5310-271-4640	NUT, PLAIN, HEXAGON MS35649-24 (96906)		EA	REF	*	*	*	*	*	*	*	*		
P-F	5310-058-3829	WASHER, LOCK MS35338-77 (96906)		EA	REF	*	*	*	*	*	*	*	*		
X1-F		POST, SUPPORTING 543-1449-002 (13499)		EA	3										
X2-F		PANEL, INDICATOR 543-1461-003 (13499)		EA	1										
X2-F		PANEL, FUSE 543-1457-000 (13499)		EA	1										
P-C	6240-143-3060	LAMP, INCANDESCENT MS15567-1 (96906)		EA	1	*	*	*	*	*	*	*	*	3-35	1A12DS1

SECTION III REPAIR PARTS FOR DIRECT SUPPORT, GENERAL SUPPORT, AND DEPOT MAINTENANCE (CONTINUED)

(1) SR CODE	(2) FEDERAL STOCK NUMBER	(3) DESCRIPTION  REFERENCE NUMBER & MFR. CODE	(4) UNIT OF MEAS	(5) QTY INC IN UNIT	(6) 30-DAY DS MAINT ALLOWANCE			(7) 30-DAY GS MAINT ALLOWANCE			(8) 1 YR ALW PER EQUIP CNTGTY	(9) DEPOT MAINT ALW PER 100 EQUIP	(10) ILLUSTRATIONS	
					(a)	(b)	(c)	(a)	(b)	(c)			(a)	(b)
					1-20	21-50	51-100	1-20	21-50	51-100			FIG NO.	ITEM NO. OR REFERENCE DESIGNATION
P-F	6210-067-8377	LAMPHOLDER 513502XP56-1 (72765)	EA	1	*	*	*	*	*	*	*	*	3-35	1A12XDG1
P-O	6210-061-2633	LENS, INCANDESCENT LIGHT 51-111 (72619)	EA	1	*	*	*	*	*	*	*	*		1A12DS2
P-F	5920-655-4133	FUSEHOLDER HKLJRWZZ (71400)	EA	1	*	*	*	*	*	*	*	*	3-35	1A12XF1
X1-H		PLATE, INSTRUCTION 280-0464-000 (13499)	EA	REF										
P-H	5305-054-5636	SCREW, MACHINE MS51957-2 (96906)	EA	REF				*	*	*	*	*		
X2-F		CHASSIS ASSEMBLY 543-1462-003 (13499)	EA	1										
X2-F		CHASSIS PLENUM 543-1467-004 (13499)	EA	1										
P-F		WASHER, FLAT 310-6360-000 (96906)	EA	REF	*	*	*	*	*	*	*	*		
P-F	5310-011-1041	WASHER, LOCK MS35338-79 (96906)	EA	REF	*	*	*	*	*	*	*	*		
P-F	5305-054-6654	SCREW, MACHINE MS1957-30 (96906)	EA	REF	*	*	*	*	*	*	*	*		
X1-F		PLATE, SLIDING 542-3236-002 (13499)	EA	REF										
P-F	5310-857-5547	NUT, SELF-LOCKING, HEXAGON MS21044D06 (96906)	EA	REF	*	*	*	*	*	*	*	*		
M-H		INSULATION TAPE 543-1454-002 (13499)	FT	1										
X2-F		CHASSIS, ELECTRICAL EQUIPMENT 542-1463-003 (13499)	EA	1										
A-O		POWER SUPPLY SUBASSEMBLY 543-1455-004 (13499)	EA	1										
P-H	5820-813-0738	TERMINAL BOARD 543-1465-004 (13499)	EA	1				*	*	*	*	*	3-35	1A12TB2
X1-H		TERMINAL BOARD 543-1464-004 (13499)	EA	REF										
X1-H		TERMINAL, STUD XL463C (71279)	EA	REF										
X1-H		TERMINAL, STUD 1370C (88245)	EA	7										
X1-H		EYELET, METALLIC A382BRSADPL (01881)	EA	2										
P-H		TERMINAL, LUG 5PL4040-4HOTFINNED (77147)	EA	REF				*	*	*	*	*		
P-H	5920-929-1999	CLIP, ELECTRICAL 122044 (75915)	EA	2				*	*	*	*	*		
P-H		POST 543-1443-002 (13499)	EA	4				*	*	*	*	*		
P-F	5961-688-6316	SEMICONDUCTOR DEVICE, DIODE 1N1C75 (07688)	EA	44	*	*	*	*	*	*	*	*	3-35	1A12CR1
P-F	5961-688-6316	SEMICONDUCTOR DEVICE, DIODE 1N1O95 (07688)	EA	REF	*	*	*	*	*	*	*	*	3-35	1A12CR2
P-F	5961-688-6313	SEMICONDUCTOR DEVICE, DIODE 1N1O95 (07688)	EA	REF	*	*	*	*	*	*	*	*	3-35	1A12CR3
P-F	5961-688-6316	SEMICONDUCTOR DEVICE, DIODE 1N1O95 (07688)	EA	REF	*	*	*	*	*	*	*	*	3-35	1A12CR4



SECTION III REPAIR PARTS FOR DIRECT SUPPORT, GENERAL SUPPORT, AND DEPOT MAINTENANCE (CONTINUED)

(1) SR CODE	(2) FEDERAL STOCK NUMBER	(3) DESCRIPTION  REFERENCE NUMBER & MFR. CODE	(4) UNIT OF MEAS	(5) QTY INC IN UNIT	(6) 30-DAY DS MAINT ALLOWANCE			(7) 30-DAY GS MAINT ALLOWANCE			(8) 1 YR ALW PER EQUIP CNTGCT	(9) DEPOT MAINT ALW PER 100 EQUIP	(10) ILLUSTRATIONS	
					(a)	(b)	(c)	(a)	(b)	(c)			(a)	(b)
					1-20	21-50	51-100	1-20	21-50	51-100			FIG NO.	ITEM NO. OR REFERENCE DESIGNATION
P-F	5961-688-6316	SEMICONDUCTOR DEVICE, DIODE N1095 (07688)	EA	REF	*	*	*	*	*	*	*	3-35	1A12CR5	
P-F	5961-688-6316	SEMICONDUCTOR DEVICE, DIODE N1095 (07688)	EA	REF	*	*	*	*	*	*	*	3-35	1A12CR6	
P-F	5961-688-6316	SEMICONDUCTOR DEVICE, DIODE N1095 (07688)	EA	REF	*	*	*	*	*	*	*	3-35	1A12CR7	
P-F	5961-688-6316	SEMICONDUCTOR DEVICE, DIODE N1095 (07688)	EA	REF	*	*	*	*	*	*	*	3-35	1A12CR8	
P-F	5961-688-6316	SEMICONDUCTOR DEVICE, DIODE N1095 (07688)	EA	REF	*	*	*	*	*	*	*	3-35	1A12CR9	
P-F	5961-688-6316	SEMICONDUCTOR DEVICE, DIODE N1095 (07688)	EA	REF	*	*	*	*	*	*	*	3-35	1A12CR10	
P-F	5961-688-6316	SEMICONDUCTOR DEVICE, DIODE N1095 (07688)	EA	REF	*	*	*	*	*	*	*	3-35	1A12CR11	
P-F	5961-688-6316	SEMICONDUCTOR DEVICE, DIODE N1095 (07688)	EA	REF	*	*	*	*	*	*	*	3-35	1A12CR12	
P-F	5961-688-6316	SEMICONDUCTOR DEVICE, DIODE N1095 (07688)	EA	REF	*	*	*	*	*	*	*	3-35	1A12CR13	
P-F	5961-688-6316	SEMICONDUCTOR DEVICE, DIODE N1095 (07688)	EA	REF	*	*	*	*	*	*	*	3-35	1A12CR14	
P-F	5961-688-6316	SEMICONDUCTOR DEVICE, DIODE N1095 (07688)	EA	REF	*	*	*	*	*	*	*	3-35	1A12CR15	
P-F	5961-688-6316	SEMICONDUCTOR DEVICE, DIODE N1095 (07688)	EA	REF	*	*	*	*	*	*	*	3-35	1A12CR16	
P-F	5961-688-6316	SEMICONDUCTOR DEVICE, DIODE N1095 (07688)	EA	REF	*	*	*	*	*	*	*	3-35	1A12CR17	
P-F	5961-688-6316	SEMICONDUCTOR DEVICE, DIODE N1095 (07688)	EA	REF	*	*	*	*	*	*	*	3-35	1A12CR18	
P-F	5961-688-6316	SEMICONDUCTOR DEVICE, DIODE N1095 (07688)	EA	REF	*	*	*	*	*	*	*	3-35	1A12CR19	
P-F	5961-688-6316	SEMICONDUCTOR DEVICE, DIODE N1095 (07688)	EA	REF	*	*	*	*	*	*	*	3-35	1A12CR20	
P-F	5961-688-6316	SEMICONDUCTOR DEVICE, DIODE N1095 (07688)	EA	REF	*	*	*	*	*	*	*	3-35	1A12CR21	
P-F	5961-688-6316	SEMICONDUCTOR DEVICE, DIODE N1095 (07688)	EA	REF	*	*	*	*	*	*	*	3-35	1A12CR22	
P-F	5961-688-6316	SEMICONDUCTOR DEVICE, DIODE N1095 (07688)	EA	REF	*	*	*	*	*	*	*	3-35	1A12CR23	
P-F	5961-688-6316	SEMICONDUCTOR DEVICE, DIODE N1095 (07688)	EA	REF	*	*	*	*	*	*	*	3-35	1A12CR24	
P-F	5961-688-6316	SEMICONDUCTOR DEVICE, DIODE N1095 (07688)	EA	REF	*	*	*	*	*	*	*	3-35	1A12CR25	
P-F	5961-688-6316	SEMICONDUCTOR DEVICE, DIODE N1095 (07688)	EA	REF	*	*	*	*	*	*	*	3-35	1A12CR26	
P-F	5961-688-6316	SEMICONDUCTOR DEVICE, DIODE N1095 (07688)	EA	REF	*	*	*	*	*	*	*	3-35	1A12CR27	
P-F	5961-688-6316	SEMICONDUCTOR DEVICE, DIODE N1095 (07688)	EA	REF	*	*	*	*	*	*	*	3-35	1A12CR28	
P-F	5961-688-6316	SEMICONDUCTOR DEVICE, DIODE N1095 (07688)	EA	REF	*	*	*	*	*	*	*	3-35	1A12CR29	
P-F	5961-688-6316	SEMICONDUCTOR DEVICE, DIODE N1095 (07688)	EA	REF	*	*	*	*	*	*	*	3-35	1A12CR30	
P-F	5961-688-6316	SEMICONDUCTOR DEVICE, DIODE N1095 (07688)	EA	REF	*	*	*	*	*	*	*	3-35	1A12CR31	

SECTION III REPAIR PARTS FOR DIRECT SUPPORT, GENERAL SUPPORT, AND DEPOT MAINTENANCE (CONTINUED)

(1) SFR CODE	(2) FEDERAL STOCK NUMBER	(3) DESCRIPTION  REFERENCE NUMBER & MFR. CODE	(4) UNIT OF MEAS	(5) QTY INC IN UNIT	(6) 30-DAY DS MAINT ALLOWANCE			(7) 30-DAY GS MAINT ALLOWANCE			(8) 1 YR ALW PER EQUIP CNTGCT	(9) DEPOT MAINT ALW PER 100 EQUIP	(10) ILLUSTRATIONS	
					(a) 1-20	(b) 21-50	(c) 51-100	(a) 1-20	(b) 21-50	(c) 51-100			(a) FIG NO.	(b) ITEM NO. OR REFERENCE DESIGNATION
P-F	5961-688-6316	SEMICONDUCTOR DEVICE, DIODE 1N1095 (07688)	EA	REF	*	*	*	*	*	*	*	3-35	1A12CR32	
P-F	5961-688-6316	SEMICONDUCTOR DEVICE, DIODE 1N1095 (07688)	EA	REF	*	*	*	*	*	*	*	3-35	1A12CR33	
P-F	5961-688-6316	SEMICONDUCTOR DEVICE, DIODE 1N1095 (07688)	EA	REF	*	*	*	*	*	*	*	3-35	1A12CR34	
P-F	5961-688-6316	SEMICONDUCTOR DEVICE, DIODE 1N1095 (07688)	EA	REF	*	*	*	*	*	*	*	3-35	1A12CR35	
P-F	5961-688-6316	SEMICONDUCTOR DEVICE, DIODE 1N1095 (07688)	EA	REF	*	*	*	*	*	*	*	3-35	1A12CR36	
P-F	5961-688-6316	SEMICONDUCTOR DEVICE, DIODE 1N1095 (07688)	EA	REF	*	*	*	*	*	*	*	3-35	1A12CR37	
P-F	5961-688-6316	SEMICONDUCTOR DEVICE, DIODE 1N1095 (07688)	EA	REF	*	*	*	*	*	*	*	3-35	1A12CR38	
P-F	5961-688-6316	SEMICONDUCTOR DEVICE, DIODE 1N1095 (07688)	EA	REF	*	*	*	*	*	*	*	3-35	1A12CR39	
P-F	5961-688-6316	SEMICONDUCTOR DEVICE, DIODE 1N1095 (07688)	EA	REF	*	*	*	*	*	*	*	3-35	1A12CR40	
P-F	5961-688-6316	SEMICONDUCTOR DEVICE, DIODE 1N1095 (07688)	EA	REF	*	*	*	*	*	*	*	3-35	1A12CR41	
P-F	5961-688-6316	SEMICONDUCTOR DEVICE, DIODE 1N1095 (07688)	EA	REF	*	*	*	*	*	*	*	3-35	1A12CR42	
P-F	5961-688-6316	SEMICONDUCTOR DEVICE, DIODE 1N1095 (07688)	EA	REF	*	*	*	*	*	*	*	3-35	1A12CR43	
P-F	5961-688-6316	SEMICONDUCTOR DEVICE, DIODE 1N1095 (07688)	EA	REF	*	*	*	*	*	*	*	3-35	1A12CR44	
P-O	5920-669-6859	FUSE, CARTRIDGE F02B250V3-8AS (81349)	EA	1	*	*	*	*	*	*	*	3-35	1A12F2	
P-F	5910-899-6542	CAPACITOR, FIXED, CERAMIC DIELECTRIC CK61AW222M (81349)	EA	44	*	*	*	*	*	*	*		1A12C5	
P-F	5910-899-6542	CAPACITOR, FIXED, CERAMIC DIELECTRIC CK61AW222M (81349)	EA	REF	*	*	*	*	*	*	*		1A12C6	
P-F	5910-899-6542	CAPACITOR, FIXED, CERAMIC DIELECTRIC CK61AW222M (81349)	EA	REF	*	*	*	*	*	*	*		1A12C7	
P-F	5910-899-6542	CAPACITOR, FIXED, CERAMIC DIELECTRIC CK61AW222M (81349)	EA	REF	*	*	*	*	*	*	*		1A12C8	
P-F	5910-899-6542	CAPACITOR, FIXED, CERAMIC DIELECTRIC CK61AW222M (81349)	EA	REF	*	*	*	*	*	*	*		1A12C9	
P-F	5910-899-6542	CAPACITOR, FIXED, CERAMIC DIELECTRIC CK61AW222M (81349)	EA	REF	*	*	*	*	*	*	*		1A12C10	
P-F	5910-899-6542	CAPACITOR, FIXED, CERAMIC DIELECTRIC CK61AW222M (81349)	EA	REF	*	*	*	*	*	*	*		1A12C11	
P-F	5910-899-6542	CAPACITOR, FIXED, CERAMIC DIELECTRIC CK61AW222M (81349)	EA	REF	*	*	*	*	*	*	*		1A12C12	
P-F	5910-899-6542	CAPACITOR, FIXED, CERAMIC DIELECTRIC CK61AW222M (81349)	EA	REF	*	*	*	*	*	*	*		1A12C13	
P-F	5910-899-6542	CAPACITOR, FIXED, CERAMIC DIELECTRIC CK61AW222M (81349)	EA	REF	*	*	*	*	*	*	*		1A12C14	
P-F	5910-899-6542	CAPACITOR, FIXED, CERAMIC DIELECTRIC CK61AW222M (81349)	EA	REF	*	*	*	*	*	*	*		1A12C15	
P-F	5910-899-6542	CAPACITOR, FIXED, CERAMIC DIELECTRIC CK61AW222M (81349)	EA	REF	*	*	*	*	*	*	*		1A12C16	
P-F	5910-899-6542	CAPACITOR, FIXED, CERAMIC DIELECTRIC CK61AW222M (81349)	EA	REF	*	*	*	*	*	*	*		1A12C17	

SECTION III REPAIR PARTS FOR DIRECT SUPPORT, GENERAL SUPPORT, AND DEPOT MAINTENANCE (CONTINUED)

(1) SR CODE	(2) FEDERAL STOCK NUMBER	(3) DESCRIPTION  REFERENCE NUMBER & MIL. CODE	(4) UNIT OF MEAS  USABLE OR CODE	(5) QTY INC IN UNIT	(6) 30-DAY DS MAINT ALLOWANCE			(7) 30-DAY GS MAINT ALLOWANCE			(8) 1 YR ALW PER EQUIP CNTGTY	(9) DEPOT MAINT ALW PER 100 EQUIP	(10) ILLUSTRATIONS	
					(a)	(b)	(c)	(a)	(b)	(c)			(a) FIG NO.	(b) ITEM NO. OR REFERENCE DESIGNATION
					1-20	21-50	51-100	1-20	21-50	51-100				
P-F	5910-899-6542	CAPACITOR, FIXED, CERAMIC DIELECTRIC CK61AW222M (81349)	EA	REF	*	*	*	*	*	*	*	*	1A12C18	
P-F	5910-899-6542	CAPACITOR, FIXED, CERAMIC DIELECTRIC CK61AW222M (81349)	EA	REF	*	*	*	*	*	*	*	*	1A12C19	
P-F	5910-899-6542	CAPACITOR, FIXED, CERAMIC DIELECTRIC CK61AW222M (81349)	EA	REF	*	*	*	*	*	*	*	*	1A12C20	
P-F	5910-899-6542	CAPACITOR, FIXED, CERAMIC DIELECTRIC CK61AW222M (81349)	EA	REF	*	*	*	*	*	*	*	*	1A12C21	
P-F	5910-899-6542	CAPACITOR, FIXED, CERAMIC DIELECTRIC CK61AW222M (81349)	EA	REF	*	*	*	*	*	*	*	*	1A12C22	
P-F	5910-899-6542	CAPACITOR, FIXED, CERAMIC DIELECTRIC CK61AW222M (81349)	EA	REF	*	*	*	*	*	*	*	*	1A12C23	
P-F	5910-899-6542	CAPACITOR, FIXED, CERAMIC DIELECTRIC CK61AW222M (81349)	EA	REF	*	*	*	*	*	*	*	*	1A12C24	
P-F	5910-899-6542	CAPACITOR, FIXED, CERAMIC DIELECTRIC JK61AW222M (81349)	EA	REF	*	*	*	*	*	*	*	*	1A12C25	
P-F	5910-899-6542	CAPACITOR, FIXED, CERAMIC DIELECTRIC CK61AW222M (81349)	EA	REF	*	*	*	*	*	*	*	*	1A12C26	
P-F	5910-899-6542	CAPACITOR, FIXED, CERAMIC DIELECTRIC CK61AW222M (81349)	EA	REF	*	*	*	*	*	*	*	*	1A12C27	
P-F	5910-899-6542	CAPACITOR, FIXED, CERAMIC DIELECTRIC CK61AW222M (81349)	EA	REF	*	*	*	*	*	*	*	*	1A12C28	
P-F	5910-899-6542	CAPACITOR, FIXED, CERAMIC DIELECTRIC CK61AW222M (81349)	EA	REF	*	*	*	*	*	*	*	*	1A12C29	
P-F	5910-899-6542	CAPACITOR, FIXED, CERAMIC DIELECTRIC CK61AW222M (81349)	EA	REF	*	*	*	*	*	*	*	*	1A12C30	
P-F	5910-899-6542	CAPACITOR, FIXED, CERAMIC DIELECTRIC CK61AW222M (81349)	EA	REF	*	*	*	*	*	*	*	*	1A12C31	
P-F	5910-899-6542	CAPACITOR, FIXED, CERAMIC DIELECTRIC CK61AW222M (81349)	EA	REF	*	*	*	*	*	*	*	*	1A12C32	
P-F	5910-899-6542	CAPACITOR, FIXED, CERAMIC DIELECTRIC CK61AW222M (81349)	EA	REF	*	*	*	*	*	*	*	*	1A12C33	
P-F	5910-899-6542	CAPACITOR, FIXED, CERAMIC DIELECTRIC CK61AW222M (81349)	EA	REF	*	*	*	*	*	*	*	*	1A12C34	
P-F	5910-899-6542	CAPACITOR, FIXED, CERAMIC DIELECTRIC CK61AW222M (81349)	EA	REF	*	*	*	*	*	*	*	*	1A12C35	
P-F	5910-899-6542	CAPACITOR, FIXED, CERAMIC DIELECTRIC CK61AW222M (81349)	EA	REF	*	*	*	*	*	*	*	*	1A12C36	
P-F	5910-899-6542	CAPACITOR, FIXED, CERAMIC DIELECTRIC CK61AW222M (81349)	EA	REF	*	*	*	*	*	*	*	*	1A12C37	
P-F	5910-899-6542	CAPACITOR, FIXED, CERAMIC DIELECTRIC CK61AW222M (81349)	EA	REF	*	*	*	*	*	*	*	*	1A12C38	
P-F	5910-899-6542	CAPACITOR, FIXED, CERAMIC DIELECTRIC CK61AW222M (81349)	EA	REF	*	*	*	*	*	*	*	*	1A12C39	
P-F	5910-899-6542	CAPACITOR, FIXED, CERAMIC DIELECTRIC CK61AW222M (81349)	EA	REF	*	*	*	*	*	*	*	*	1A12C40	
P-F	5910-899-6542	CAPACITOR, FIXED, CERAMIC DIELECTRIC CK61AW222M (81349)	EA	REF	*	*	*	*	*	*	*	*	1A12C41	
P-F	5910-899-6542	CAPACITOR, FIXED, CERAMIC DIELECTRIC CK61AW222M (81349)	EA	REF	*	*	*	*	*	*	*	*	1A12C42	
P-F	5910-899-6542	CAPACITOR, FIXED, CERAMIC DIELECTRIC CK61AW222M (81349)	EA	REF	*	*	*	*	*	*	*	*	1A12C43	
P-F	5910-899-6542	CAPACITOR, FIXED, CERAMIC DIELECTRIC CK61AW222M (81349)	EA	REF	*	*	*	*	*	*	*	*	1A12C44	

SECTION III REPAIR PARTS FOR DIRECT SUPPORT, GENERAL SUPPORT, AND DEPOT MAINTENANCE (CONTINUED)

(1) SPL CODE	(2) FEDERAL STOCK NUMBER	(3) DESCRIPTION  REFERENCE NUMBER & MFR. CODE  USABLE ON CODE	(4) UNIT OF MEAS	(5) QTY INC IN UNIT	(6) 30-DAY DS MAINT ALLOWANCE			(7) 30-DAY GS MAINT ALLOWANCE			(8) 1 YR ALW PER EQUIP CNTGCT	(9) DEPOT MAINT ALW PER 100 EQUIP	(10) ILLUSTRATIONS	
					(a) 1-20	(b) 21-50	(c) 51-100	(a) 1-20	(b) 21-50	(c) 51-100			(a) FIG NO.	(b) ITEM NO. OR REFERENCE DESIGNATION
P-F	5910-899-6542	CAPACITOR, FIXED, CERAMIC DIELECTRIC CK61AW222M (81349)	EA	REF	*	*	*	*	*	*	*			1A12C45
P-F	5910-899-6542	CAPACITOR, FIXED, CERAMIC DIELECTRIC CK61AW222M (81349)	EA	REF	*	*	*	*	*	*	*			1A12C46
P-F	5910-899-6542	CAPACITOR, FIXED, CERAMIC DIELECTRIC CK61AW222M (81349)	EA	REF	*	*	*	*	*	*	*			1A12C47
P-F	5910-899-6542	CAPACITOR, FIXED, CERAMIC DIELECTRIC CK61AW222M (81349)	EA	REF	*	*	*	*	*	*	*			1A12C48
P-F		SCREW, MACHINE P343-0329-000 (77250)	EA	REF	*	*	*	*	*	*	*			
M-H		WIRE, ELECTRICAL 00702-1320 (70567)	FT	REF										
M-H		INSULATION SLEEVING, ELECTRICAL TEFTW20B (81851)	FT	REF										
A-F		SWITCH, PUSH 543-1460-003 (13499)	EA	1								3-35		1A12S2
P-H		INSULATOR, STANDOFF NS5W0210 (81350)	EA	1				*	*	*	*			
P-H	5970-296-1158	INSULATOR, STANDOFF NS5W0212 (81350)	EA	1				*	*	*	*			
P-H	5930-269-9610	ADPATER, SWITCH ACTUATOR J55 (91929)	EA	1				*	*	*	*			1A12M1
P-F	5930-548-8338	SWITCH, SENSITIVITY 11SM3T (91929)	EA	1	*	*	*	*	*	*	*	3-35		1A12S1
M-H		WASHER, NONMETALLIC 302-0030-000 (05284)	EA	4										
P-F	5310-058-3829	WASHER, LOCK MS35338-77 (96906)	EA	REF	*	*	*	*	*	*	*			
P-F	5305-059-8475	SCREW, MACHINE MS35216-41 (96906)	EA	REF	*	*	*	*	*	*	*			
P-F	5305-054-5637	SCREW, MACHINE MS1957-3 (96906)	EA	REF	*	*	*	*	*	*	*			
P-H	5305-054-5641	SCREW, MACHINE MS51957-7 (96906)	EA	2				*	*	*	*			
P-H		POST, SPACING 540-9014-003 (13499)	EA	2				*	*	*	*			
X2-H		FRAME, SWITCH 543-1459-003 (13499)	EA	1				*	*	*	*			
P-H		SHAFT 543-1446-002 (13499)	EA	1				*	*	*	*			
P-H		SPRING, HELICAL 543-1448-002 (13499)	EA	2				*	*	*	*			
X1-H		DISC, SHORTING 543-1450-002 (13499)	EA	1				*	*	*	*			
X1-H		DISC, SHORTING 543-1451-002 (13499)	EA	1				*	*	*	*			
X2-H		PLATE, SHORTING 543-1452-002 (13499)	EA	1				*	*	*	*			
P-H		SHIM 543-0463-002 (13499)	EA	1				*	*	*	*			
P-H	5315-058-9731	PIN, SPRING MS16562-213 (96906)	EA	2				*	*	*	*			
A-O		KIT, FUSE 543-1441-000 (13499)	EA	1				*	*	*	*			

SECTION III REPAIR PARTS FOR DIRECT SUPPORT, GENERAL SUPPORT, AND DEPOT MAINTENANCE (CONTINUED)

(1) S/R CODE	(2) FEDERAL STOCK NUMBER	(3) DESCRIPT:ON  REFERENCE NUMBER & MFR. CODE	(4) UNIT OF MEAS	(5) QTY INC IN UNIT	(6) 30-DAY DS MAINT ALLOWANCE			(7) 30-DAY GS MAINT ALLOWANCE			(8) 1 YR ALW PER EQUIP CNTGCT	(9) DEPOT MAINT ALW PER 100 EQUIP	(10) ILLUSTRATIONS	
					(a) 1-20	(b) 21-50	(c) 51-100	(a) 1-20	(b) 21-50	(c) 51-100			(a) FIG NO.	(b) ITEM NO. OR REFERENCE DESIGNATION
M-O		ENVELOPE, PACKAGING Q25-0001-000 (13499)	EA	4										
P-O	5920-519-7733	FUSE, CARTRIDGE FO3A250V8AS (81349)	EA	1	*	*	*	*	*	*	*	3-35	1A12F1	
P-O	5920-243-3788	FUSE, CARTRIDGE FO3A250V15AS (81349)	EA	1	*	*	*	*	*	*	*	3-35	1A12F1	
A-F		CABLE ASSEMBLY, ELECTRICAL 543-1446-000 (13499)	EA	1										
M-H		WIRE, ELECTRICAL MILW16878TYPE12-90 (81349)	FT	4										
M-H		WIRE, ELECTRICAL MILW16878TYPE12-91 (81349)	FT	5										
M-H		WIRE, ELECTRICAL MILW16878TYPE12-93 (81349)	FT	1										
M-H		WIRE, ELECTRICAL MILW16878TYPE12-95 (81349)	FT	2										
M-H		WIRE, ELECTRICAL MILW16878TYPE20-5 (81349)	FT	12										
M-H		WIRE, ELECTRICAL MILW16878TYPE20-91 (81349)	FT	REF										
M-H		WIRE, ELECTRICAL MILW16878TYPE20-92 (81349)	FT	10										
M-H		WIRE, ELECTRICAL MILW16878TYPE20-93 (81349)	FT	5										
M-H		WIRE, ELECTRICAL MILW16878TYPE20-903 (81349)	FT	3										
M-H		WIRE, ELECTRICAL MILW16878TYPE20-905 (81349)	FT	3										
M-H		WIRE, ELECTRICAL MILW16878TYPE18-902 (81349)	FT	12										
M-H		WIRE, ELECTRICAL MILW16878TYPE18-905 (81349)	FT	2										
M-H		WIRE, ELECTRICAL MILW16878TYPE18-9 (81349)	FT	1										
M-H		WIRE, ELECTRICAL MILW16878TYPE18-912 (81349)	FT	3										
M-H		WIRE, ELECTRICAL MILW16878TYPE18-913 (81349)	FT	3										
M-H		WIRE, ELECTRICAL MILW16878TYPE22-923 (81349)	FT	REF										
M-H		WIRE, ELECTRICAL MILW16878TYPE22-925 (81349)	FT	REF										
P-H	5940-557-1629	TERMINAL, LUG MS25036-49 (96906)	EA	1				*	*	*	*			
P-H	5940-331-2892	TERMINAL, LUG 31891 (00779)	EA	4				*	*	*	*			
P-H	5940-271-8298	TERMINAL, LUG 31902 (00779)	EA	2				*	*	*	*			
P-H	5940-143-4775	TERMINAL, LUG 35108 (00779)	EA	4				*	*	*	*			
M-H		TERMINAL, LUG MS25036-2 (96906)	EA	REF										
P-H	5940-246-3853	TERMINAL, LUG 32442 (00779)	EA	5				*	*	*	*			

SECTION III REPAIR PARTS FOR DIRECT SUPPORT, GENERAL SUPPORT, AND DEPOT MAINTENANCE (CONTINUED)

(1) SHR CODE	(2) FEDERAL STOCK NUMBER	(3) DESCRIPTION  REFERENCE NUMBER & REF. CODE	(4) UNIT OF MEAS	(5) QTY INC IN UNIT	(6) 30-DAY DS MAINT ALLOWANCE			(7) 30-DAY GS MAINT ALLOWANCE			(8) 1 YR ALW PER EQUIP CRYSCK	(9) DEPOT MAINT ALW PER 100 EQUIP	(10) ILLUSTRATIONS		
					USABLE ON CODE	(a) 1-20	(b) 21-50	(c) 51-100	(a) 1-20	(b) 21-50			(c) 51-100	(a) FIG NO.	(b) ITEM NO. OR REFERENCE DESIGNATION
P-H	5940-721-1785	TERMINAL, LUG 34805 (00779)	EA	1				*	*	*	*	*			
P-H		CORD, NYLON 435-1014-000 (13499)	FT	REF				*	*	*	*	*			
M-D		PLATE IDENTIFICATION 543-1640-002 (13499)	EA	REF											
M-E		INSULATION SLEEVING, ELECTRICAL 152-2166-000 (13499)	FT	1											
M-H		INSULATION SLEEVING, ELECTRICAL 152-2194-000 (13499)	FT	1											
M-H		WIRE, ELECTRICAL MILW16878TYPED18-906 (81349)	FT	1											
P-O		KIT, MOUNTING 541-1477-002 (13499)	EA	REF	*	*	*	*	*	*	*	*	*		
M-H		BAG, COTTON 024-0100-000 (13499)	EA	REF											
P-O		5310-054-1830	WASHER, LOCK MS35338-80 (96906)	EA	REF	*	*	*	*	*	*	*	*		
P-O			WASHER, FLAT 310-0167-000 (79807)	EA	REF	*	*	*	*	*	*	*	*		
P-O	WASHER, LOCK 310-0286-000 (13499)		EA	REF	*	*	*	*	*	*	*	*			
P-O	5305-579-3507	SCREW, MACHINE MS35216-40 (96906)	EA	REF	*	*	*	*	*	*	*	*			
P-O		SCREW, MACHINE P343-0247-000 (77250)	EA	REF	*	*	*	*	*	*	*	*			
A-O-R		GROUP 05 - AMPLIFIER, POWER 367A-3 AMPLIFIER, POWER 367A-3 522-0864-000 (13499)	EA	1									3-1	LA3	
P-O	5355-814-4340	KNOB 542-7447-003 (13499)	EA	1	*	*	*	*	*	*	*	*		LA301	
P-F	5305-054-5648	SCREW, MACHINE MS51957-14 (96906)	EA	REF	*	*	*	*	*	*	*	*			
P-F		5355-832-7210	SKIRT, KNOB 542-7434-003 (13499)	EA	3	*	*	*	*	*	*	*	*		
XI-F	SKIRT, KNOB 542-6944-003 (13499)		EA	3											
XI-H	PIN, SHOULDER HEADED 542-7415-002 (13499)		EA	3											
P-H	5355-774-5221	GEAR, SPUR 542-7414-002 (13499)	EA	2				*	*	*	*	*		LA3MP9	
P-H		GEAR, SPUR 542-7414-002 (13499)	EA	REF				*	*	*	*	*		LA3MP10	
P-O	5820-936-8378	KNOB, DIAL COUNTER 542-7411-002 (13499)	EA	3	*	*	*	*	*	*	*	*			
XI-H		SETSCREW 328-0022-000 (08664)	EA	6											
P-O	5820-936-8378	JIG, ADJUSTING 547-9149-002 (13499)	EA	5	*	*	*	*	*	*	*	*			
A-H		KIT, ARM 542-0464-000 (13499)	EA	1											
M-O		ENVELOPE, PACKAGING 025-0001-000 (13499)	EA	REF											

SECTION III REPAIR PARTS FOR DIRECT SUPPORT, GENERAL SUPPORT, AND DEPOT MAINTENANCE (CONTINUED)

(1) S/R CODE	(2) FEDERAL STOCK NUMBER	(3) DESCRIPTION  REFERENCE NUMBER & MFR. CODE	(4) UNIT OF MEAS	(5) QTY INC IN UNIT	(6) 30-DAY DS MAINT ALLOWANCE			(7) 30-DAY GS MAINT ALLOWANCE			(8) 1 YR ALW PER EQUIP CNTCTY	(9) DEPOT MAINT ALW PER 100 EQUIP	(10) ILLUSTRATIONS	
					(a)	(b)	(c)	(a)	(b)	(c)			(a)	(b)
					1-20	21-50	51-100	1-20	21-50	51-100			FIG NO.	ITEM NO. OR REFERENCE DESIGNATION
X1-H		ARM, INTERLOCK 543-C378-002 (13499)	EA	1										
X1-H		ARM, INTERLOCK 543-0321-002 (13499)	EA	1										
X1-H		PLATE, INTERLOCK, ARM 543-0377-002 (13499)	EA	1										
P-F	5305-054-5649	SCREW, MACHINE MS51957-15 (96906)	EA	REF	*	*	*	*	*	*	*	*		
A-H		DOOR, ACCESS 543-0409-003 (13499)	EA	1										
X2-H		DOOR, ACCESS 543-0408-003 (13499)	EA	1										
X1-H		CONTACT, ELECTRICAL 543-0359-002 (13499)	EA	1										
X1-H		CONTACT, ELECTRICAL 543-0360-002 (13499)	EA	1										
X1-H		CONTACT, ELECTRICAL 543-0361-002 (13499)	EA	1										
X1-H		STRAP, MOUNTING 543-0364-002 (13499)	EA	1										
X1-H		STRAP, MOUNTING 543-0365-002 (13499)	EA	1										
X1-H		STRAP, MOUNTING 543-0366-002 (13499)	EA	1										
X2-H		RIVET, TUBULAR R4008X1-8CHROMATEDP (12014)	EA	REF										
P-H		PIN, STRAIGHT, HEADLESS 543-0317-002 (13499)	EA	1				*	*	*	*	*		
P-H	5325-171-4882	STUD, TURNLOCK 2-0-120 (75618)	EA	2				*	*	*	*	*		
X1-H		EYELET, TURNLOCK S2-31-293-25 (75618)	EA	2										
A-H		HANDLE 543-0389-002 (13499)	EA	1										
X1-H		HANDLE 543-0388-002 (13499)	EA	1										
X2-H		HANDLE, CASTING 543-0388-012 (13499)	EA	1										
P-H		PIN, GROOVED, HEADLESS GP4-125X0250-50 (73957)	EA	1				*	*	*	*	*		
P-F	5305-054-6652	SCREW, MACHINE MS51957-28 (96906)	EA	REF	*	*	*	*	*	*	*	*		
P-F	5310-043-1754	WASHER, LOCK MS3537-79 (96906)	EA	9	*	*	*	*	*	*	*	*		
P-F		CONTACT, ELECTRICAL 543-0363-002 (13499)	EA	1	*	*	*	*	*	*	*	*		
X1-F		STRAP, MOUNTING 543-0368-002 (13499)	EA	1										
P-F	5310-907-0958	WASHER, FLAT 310-0045-000 (96906)	EA	REF	*	*	*	*	*	*	*	*		
A-O		PANEL, POWER 543-0421-004 (13499)	EA	1										
P-O	6240-223-9100	LAMP, GLOW NE51 (08805)	EA	1	*	*	*	*	*	*	*	*	3-36	1A3DS1

SECTION III REPAIR PARTS FOR DIRECT SUPPORT, GENERAL SUPPORT, AND DEPOT MAINTENANCE (CONTINUED)

(1) SMR CODE	(2) FEDERAL STOCK NUMBER	(3) DESCRIPTION  REFERENCE NUMBER & MFR. CODE	(4) UNIT OF MEAS	(5) QTY INC IN UNIT	(6) 30-DAY DS MAINT ALLOWANCE			(7) 30-DAY GS MAINT ALLOWANCE			(8) 1 YR ALW PER EQUIP CATGCT	(9) DEPOT MAINT ALW PER 100 EQUIP	(10) ILLUSTRATIONS	
					(a) 1-20	(b) 21-50	(c) 51-100	(a) 1-20	(b) 21-50	(c) 51-100			(a) FIG NO.	(b) ITEM NO. OR REFERENCE DESIGNATION
P-F	6210-023-8555	LAMPHOLDER 50 (72765)	EA	1	*	*	*	*	*	*	*	3-36	1A3XDS1	
P-F	5920-027-0801	FUSEHOLDER 340166 (79515)	EA	1	*	*	*	*	*	*	*	3-36	1A3XF1	
P-F	5930-615-7897	SWITCH, TOGGLE MS35059-31 (96906)	EA	1	*	*	*	*	*	*	*	3-36	1A3S9	
P-F	5930-050-2681	SWITCH, TOGGLE ST42B (81350)	EA	2	*	*	*	*	*	*	*	3-36	1A3S2	
P-F	5930-050-2681	SWITCH, TOGGLE ST42B (81350)	EA	REF	*	*	*	*	*	*	*	3-36	1A3S3	
XI-F		BUTTON, PLUG 48186BRSBLKNIPL (61864)	EA	2										
P-F	5305-054-5652	SCREW, MACHINE MS51957-18 (96906)	EA	6	*	*	*	*	*	*	*			
P-F		NUT, PLAIN, HEXAGON P313-0132-000 (77250)	EA	REF	*	*	*	*	*	*	*			
P-H	6625-812-9785	AMMETER 1120HBLOIDCMA (81030)	EA	1				*	*	*	*	3-36	1A3M1	
P-O	6210-299-3025	LENS, INDICATOR 52-991 (72619)	EA	1	*	*	*	*	*	*	*		1A3DS4	
P-O	5355-668-3295	KNOB-BAR 508-1103-200 (13499)	EA	2	*	*	*	*	*	*	*			
P-F	5930-755-5834	SWITCH, ROTARY 185146F1 (76854)	EA	1	*	*	*	*	*	*	*	3-36	1A3S1	
A-F		PLATE, AMPLIFIER 543-0413-004 (13499)	EA	1										
X2-F		PLATE, AMPLIFIER 543-0412-004 (13499)	EA	1										
XI-F		CONTACT, ELECTRICAL 543-0362-002 (13499)	EA	1										
XI-F		STRAP, MOUNTING 543-0367-002 (13499)	EA	1										
XI-F		RIVET, TUBULAR R4008X3-16CHROMATEDP (12014)	EA	3										
P-F		INSERT, SCREW THREADED MS124663 (96906)	EA	2	*	*	*	*	*	*	*			
P-H	5320-117-6938	RIVET, SOLID MS20426AD3-4 (96906)	EA	REF				*	*	*	*			
P-F	5935-683-7657	JACK, TIP SKTIOBLU (98291)	EA	1	*	*	*	*	*	*	*	3-36	1A3J5	
P-F	5935-617-6837	JACK, TIP SKT10WHT (98291)	EA	1	*	*	*	*	*	*	*	3-36	1A3J4	
XI-F		BEZEL, INSTRUMENT, MOUNTING A1-481-1 (81030)	EA	REF										
X2-F		MOUNTING PLATE A1-480-2 (81030)	EA	REF										
P-F		NUT, HEXAGON 1002-008 (81030)	EA	REF	*	*	*	*	*	*	*			
P-F		SPLIT, LOCKWASHER 1452-008 (81030)	EA	REF	*	*	*	*	*	*	*			
P-F		ROUND HEAD SCREW 1501-412 (81030)	EA	REF	*	*	*	*	*	*	*			
M-H		CLAMP, LOOP HP4H (09922)	EA	REF										



SECTION III REPAIR PARTS FOR DIRECT SUPPORT, GENERAL SUPPORT, AND DEPOT MAINTENANCE (CONTINUED)

(1) SRR CODE	(2) FEDERAL STOCK NUMBER	(3) DESCRIPTION  REFERENCE NUMBER & MFR. CODE	(4) UNIT OF MEAS	(5) QTY INC IN UNIT	(6) 30-DAY DS MAINT ALLOWANCE			(7) 30-DAY GS MAINT ALLOWANCE			(8) 1 YR ALW PER EQUIP CWTQCY	(9) DEPOT MAINT ALW PER 100 EQUIP	(10) ILLUSTRATIONS	
					(a) 1-20	(b) 21-50	(c) 51-100	(a) 1-20	(b) 21-50	(c) 51-100			(a) FIG NO.	(b) ITEM NO. OR REFERENCE DESIGNATION
P-F	5940-500-7227	TERMINAL, LUG 31-759 (02660)	EA	REF	*	*	*	*	*	*	*	*		
P-F		NUT, PLAIN, HEXAGON P334-4120-000 (77250)	EA	REF	*	*	*	*	*	*	*	*		
P-F		WASHER, LOCK 1720-02CADPL (78189)	EA	REF	*	*	*	*	*	*	*	*		
P-F	5310-269-6291	NUT, PLAIN, HEXAGON 8947-151 (04009)	EA	3	*	*	*	*	*	*	*	*		
P-F		WASHER, LOCK 1722-01CADPL (78189)	EA	REF	*	*	*	*	*	*	*	*		
P-F	5355-679-9325	DIAL, SCALE 542-7428-003 (13499)	EA	2	*	*	*	*	*	*	*	*		1A3DS5
P-F	5355-679-9325	DIAL, SCALE 542-7428-003 (13499)	EA	REF	*	*	*	*	*	*	*	*		1A3DS6
XI-F		GEAR, SPUR, FIXED 542-7416-002 (13499)	EA	3										
XI-F		DIAL, SCALE--2 INCH 542-7457-004 (13499)	EA	2										
P-F		SCREW, MACHINE P320-0008-000 (77250)	EA	4	*	*	*	*	*	*	*	*		
P-F	5355-679-9326	POINTER, DIAL 542-6948-002 (13499)	EA	2	*	*	*	*	*	*	*	*		1A3DS7
P-F	5355-679-9326	POINTER, DIAL 542-6948-002 (13499)	EA	REF	*	*	*	*	*	*	*	*		1A3DS8
P-F		WASHER, KNOB 542-7417-002 (13499)	EA	3	*	*	*	*	*	*	*	*		
P-F		SCREW, MACHINE P343-0328-000 (77250)	EA	REF	*	*	*	*	*	*	*	*		
P-F	5310-275-1347	WASHER, FLAT 310-0045-000 (77250)	EA	REF	*	*	*	*	*	*	*	*		
P-H	5820-787-3482	GEAR, SPUR 542-7439-003 (13499)	EA	2				*	*	*	*	*		1A3MP1
P-H	5820-787-3482	GEAR, SPUR 542-7439-003 (13499)	EA	REF				*	*	*	*	*		1A3MP2
XI-H		BEARING, SLEEVING F346MILL6085A (70417)	EA	4										
XI-H		GEAR, SPUR 542-7421-002 (13499)	EA	2										
P-F		SETScrew 328-0020-000 (08664)	EA	7	*	*	*	*	*	*	*	*		
P-F		SCREW, MACHINE P342-0313-000 (77250)	EA	4	*	*	*	*	*	*	*	*		
XI-F		PLATE, NUT-DIAL 544-9749-002 (13499)	EA	2										
X2-F		PLATE, DIAL, ADJUSTING 544-9750-002 (13499)	EA	2										
P-F	5310-907-0958	WASHER, FLAT 310-0045-000 (79807)	EA	REF	*	*	*	*	*	*	*	*		
A-F		PLATE, MOUNTING, AMPLIFIER 543-0417-004 (13499)	EA	1										
P-F	5310-011-1041	WASHER, LOCK MS39338-79 (96906)	EA	REF	*	*	*	*	*	*	*	*		
P-F		WASHER, FLAT 310-6360-000 (79807)	EA	REF	*	*	*	*	*	*	*	*		

SECTION III REPAIR PARTS FOR DIRECT SUPPORT, GENERAL SUPPORT, AND DEPOT MAINTENANCE (CONTINUED)

(1) SFR CODE	(2) FEDERAL STOCK NUMBER	(3) DESCRIPTION  REFERENCE NUMBER & MFR. CODE	(4) UNIT OF MEAS	(5) QTY INC IN UNIT	(6) 30-DAY DS MAINT ALLOWANCE			(7) 30-DAY GS MAINT ALLOWANCE			(8) 1 YR ALW PER EQUIP CNTGCTY	(9) DEPOT MAINT ALW PER 100 EQUIP	(10) ILLUSTRATIONS		
					USABLE OM CODE	(a) 1-20	(b) 21-50	(c) 51-100	(a) 1-20	(b) 21-50			(c) 51-100	(a) FIG NO.	(b) ITEM NO. OR REFERENCE DESIGNATION
P-F		WASHER 543-5607-003 (13499)	EA	2		*	*	*	*	*	*				
P-F	5310-857-5547	NUT, SELF-LOCKING, HEXAGON MS21044D06 (96906)	EA	REF		*	*	*	*	*	*				
P-F	5305-054-6655	SCREW, MACHINE MS51957-31 (96906)	EA	2		*	*	*	*	*	*				
X2-F		PLATE-SLIDING 553-7196-002 (13499)	EA	1											
X1-F		PLATE, SLIDING 542-3236-002 (13499)	EA	REF											
X1-F		AMPLIFIER, PLATE 543-0416-004 (13499)	EA	1											
A-O		KIT, FUSE 543-0301-000 (13499)	EA	1											
M-O		ENVELOPE, PACKAGING 025-0001-000 (13499)	EA	REF											
P-O	5920-281-0224	FUSE, CARTRIDGE FO2A250V1-2AS (81349)	EA	1		*	*	*	*	*	*	3-36	1A3F1		
P-O	5920-280-4465	FUSE, CARTRIDGE FO2A250V1AS (81349)	EA	1		*	*	*	*	*	*	3-36	1A3F1		
P-O	5355-668-3295	KNOB-BAR 508-1103-200 (13499)	EA	REF		*	*	*	*	*	*				
P-F		SETSCREW 328-0020-000 (08664)	EA	REF		*	*	*	*	*	*				
A-O		AMPLIFIER SUBASSEMBLY 543-0300-000 (13499)	EA	1											
X2-F		CHASSIS, ELECTRICAL EQUIPMENT 543-0415-004 (13499)	EA	1											
X2-F		CHASSIS, ELECTRICAL EQUIPMENT 543-0414-004 (13499)	EA	1											
P-F	5310-584-8129	NUT, SELF-LOCKING, CLINCH 68NC1-40 (72962)	EA	REF		*	*	*	*	*	*				
P-F	5310-297-9071	NUT, SELF-LOCKING, CLINCH 68NC2-62 (72962)	EA	REF		*	*	*	*	*	*				
P-F		NUT, CAPTIVE 543-0435-002 (13499)	EA	REF		*	*	*	*	*	*				
X2-F		CHASSIS, ELECTRICAL EQUIPMENT 543-0434-006 (13499)	EA	1											
P-H	5310-297-9070	NUT, SELF-LOCKING, CLINCH 68NC2-40 (72962)	EA	REF				*	*	*	*				
X2-H		BLOCK, CENTER-TAPPED 543-0410-003 (13499)	EA	1											
X1-H		BLOCK, HINGE 543-0370-002 (13499)	EA	2											
X1-H		PLATE, PIVOT 540-643-002 (13499)	EA	2											
X2-H		PLATE, HINGE 540-6260-002 (13499)	EA	REF											
X1-H		PIN, GROOVED 541-3627-002 (13499)	EA	REF											
X2-H		PLATE, HINGE 540-6236-002 (13499)	EA	REF											
P-F		SCREW, MACHINE P342-0070-000 (77250)	EA	4		*	*	*	*	*	*				

SECTION III REPAIR PARTS FOR DIRECT SUPPORT, GENERAL SUPPORT, AND DEPOT MAINTENANCE (CONTINUED)

(1) SIR CODE	(2) FEDERAL STOCK NUMBER	(3) DESCRIPTION  REFERENCE NUMBER & MFR. CODE	(4) UNIT OF MEAS	(5) QTY INC IN UNIT	(6) 30-DAY DS MAINT ALLOWANCE			(7) 30-DAY GS MAINT ALLOWANCE			(8) 1 YR ALW PER EQUIP CMTGCT	(9) DEPOT MAINT ALW PER 100 EQUIP	(10) ILLUSTRATIONS	
					(a) 1-20	(b) 21-50	(c) 51-100	(a) 1-20	(b) 21-50	(c) 51-100			(a) FIG NO.	(b) ITEM NO., OR REFERENCE DESIGNATION
P-F	5315-965-1835	PIN, GROOVED MS35672-24 (96906)	EA	4	*	*	*	*	*	*	*			
P-F	5340-634-7444	RING, RETAINING MS16632-1018 (96906)	EA	REF	*	*	*	*	*	*	*			
X2-F		PLATE, HINGE 540-6240-002 (13499)	EA	REF										
P-F	5315-791-7836	SCREW, EXTERNALLY RELIEVED BODY 540-6241-002 (13499)	EA	REF	*	*	*	*	*	*	*			
P-F		SCREW, MACHINE P343-0331-000 (77250)	EA	10	*	*	*	*	*	*	*			
A-F		SWITCH ASSEMBLY, ROTARY 543-0404-003 (13499)	EA	1								3-37	1A356	
P-F	5930-760-0434	CONTACT ASSEMBLY, ELECTRICAL S21302 (74217)	EA	1	*	*	*	*	*	*	*			
P-F	5930-868-3075	CONTACT ASSEMBLY 269-1879-000 (13499)	EA	1	*	*	*	*	*	*	*			
P-F		WASHER, NONMETALLIC 302-0026-000 (05284)	EA	20	*	*	*	*	*	*	*			
P-F		WASHER, FLAT 310-0056-000 (79807)	EA	16	*	*	*	*	*	*	*			
P-F	5310-209-6069	WASHER, LOCK 310-0077-000 (79807)	EA	REF	*	*	*	*	*	*	*			
P-F		NUT, PLAIN, HEXAGON P313-0140-000 (77250)	EA	REF	*	*	*	*	*	*	*			
P-F		SETSCREW 328-0018-000 (13499)	EA	14	*	*	*	*	*	*	*			
P-F		SETSCREW 328-0507-010 (13499)	EA	14	*	*	*	*	*	*	*			
P-F		SETSCREW 328-0019-000 (13499)	EA	1	*	*	*	*	*	*	*			
P-F		SPACER, SLEEVE 543-0328-002 (13499)	EA	2	*	*	*	*	*	*	*			
P-F		SPACER, SLEEVE 543-0329-002 (13499)	EA	2	*	*	*	*	*	*	*			
P-F		SPACER, SLEEVE 543-0330-002 (13499)	EA	2	*	*	*	*	*	*	*			
P-F		SPACER, SLEEVE 543-0331-002 (13499)	EA	2	*	*	*	*	*	*	*			
P-F		SHAFT, STRAIGHT 543-0306-002 (13499)	EA	1	*	*	*	*	*	*	*			
P-F	3040-868-5900	CAM, SWITCH 543-0382-002 (13499)	EA	1	*	*	*	*	*	*	*			
X1-F		POST, SPACING SWITCH 543-0327-002 (13499)	EA	2										
A-F		PLATE, SWITCH 543-0314-002 (13499)	EA	1										
X1-F		BEARING, SLEEVE FF310MILL6035A (70417)	EA	2										
X1-F		PLATE, SWITCH FRONT 543-0302-002 (13499)	EA	1										
P-F	5310-275-1693	NUT, SELF-LOCKING, CLINCH 68NC3-62 (72962)	EA	2	*	*	*	*	*	*	*			
A-F		PLATE, SWITCH 544-7078-002 (13499)	EA	1										

SECTION III REPAIR PARTS FOR DIRECT SUPPORT, GENERAL SUPPORT, AND DEPOT MAINTENANCE (CONTINUED)

(1) SMR CODE	(2) FEDERAL STOCK NUMBER	(3) DESCRIPTION  REFERENCE NUMBER & MFR. CODE	(4) UNIT OF MEAS  USABLE ON CODE	(5) QTY INC IN UNIT	(6) 30-DAY DS MAINT ALLOWANCE			(7) 30-DAY GS MAINT ALLOWANCE			(8) 1 YR ALW PER EQUIP CNTGTY	(9) DEPOT MAINT ALW PER 100 EQUIP	(10) ILLUSTRATIONS	
					(a) 1-20	(b) 21-50	(c) 51-100	(a) 1-20	(b) 21-50	(c) 51-100			(a) FIG NO.	(b) ITEM NO. OR REFERENCE DESIGNATION
					X1-F		BEARING, SLEEVE FF31GMILL60E5A (70417)	EA	REF					
X1-F		PLATE, SWITCH 543-0326-002 (13499)	EA	1										
P-F	5930-686-2648	SWITCH SUBASSEMBLY 543-0459-003 (13499)	EA	1	*	*	*	*	*	*	*	3-37	1A3S5	
X1-F		EYELET, METALLIC SE34CADPL (90030)	EA	REF										
X1-F		SUPPORT, SWITCH 543-0438-002 (13499)	EA	1										
X1-F		SPRING, SWITCH 543-0448-002 (13499)	EA	1										
X1-F		CONTACT, ELECTRICAL CR87A (73949)	EA	2										
X1-F		EYELET, METALLIC SE36CADPL (90030)	EA	2										
X2-F		FOLLOWER, CAM 543-0439-002 (13499)	EA	1										
X1-F		CONTACT, ELECTRICAL SWITCH 543-0458-003 (13499)	EA	1										
X1-F		SPRING, SWITCH 543-0449-002 (13499)	EA	1										
X1-F		CONTACT, ELECTRICAL 1624FSCHO (24817)	EA	2										
X1-F		SWITCH, UPPER 543-0454-003 (13499)	EA	1										
X1-F		SPRING, SWITCH, LOWER 543-0450-002 (13499)	EA	1										
X1-F		CONTACT, ELECTRICAL 1624FSCHO (24817)	EA	REF										
X1-F		SPRING, ELECTRICAL CONTACT 543-0436-002 (13499)	EA	1										
P-F	5930-044-4969	ROTOR, ELECTRICAL SWITCH 269-1876-000 (74217)	EA	1	*	*	*	*	*	*	*			
P-F	5930-615-6253	ROTOR, ELECTRICAL SWITCH S21300 (71628)	EA	1	*	*	*	*	*	*	*			
P-F	5340-598-1300	RING, RETAINING 5133-25C (79136)	EA	1	*	*	*	*	*	*	*			
X1-F		LEAD, ELECTRICAL SWITCH 543-0386-002 (13499)	EA	1										
P-H	5305-054-5639	SCREW, MACHINE MS51957-5 (96906)	EA	REF				*	*	*	*			
M-H		WASHER, NONMETALLIC 302-0024-000 (35284)	EA	5										
P-F	5310-271-4640	NUT, PLAIN, HEXAGON MS35649-24 (96906)	EA	REF	*	*	*	*	*	*	*			
P-F		WASHER, FLAT 310-6320-000 (79807)	EA	REF	*	*	*	*	*	*	*			
P-F	5315-273-7979	PIN, GROOVED, HEXAGON MS35672-8 (96906)	EA	2	*	*	*	*	*	*	*			
P-F	5315-579-2898	PIN, GROOVED, HEXAGON MS35672-9 (96906)	EA	1	*	*	*	*	*	*	*			
A-H		ARM, CONNECTOR 544-7226-002 (13499)	EA	1										

SECTION III REPAIR PARTS FOR DIRECT SUPPORT, GENERAL SUPPORT, AND DEPOT MAINTENANCE (CONTINUED)

(1) SR CODE	(2) FEDERAL STOCK NUMBER	(3) DESCRIPTION  REFERENCE NUMBER & MFR. CODE	(4) UNIT OF MEAS  USABLE ON CODE	(5) QTY INE IN UNIT	(6) 30-DAY DS MAINT ALLOWANCE			(7) 30-DAY GS MAINT ALLOWANCE			(8) 1 YR ALW PER EQUIP CNTGCT	(9) DEPOT MAINT ALW PER 100 EQUIP	(10) ILLUSTRATIONS	
					(a)	(b)	(c)	(a)	(b)	(c)			(a)	(b)
					1-20	21-50	51-100	1-20	21-50	51-100			FIG NO.	ITEM NO. OR REFERENCE DESIGNATION
XI-H		POST, CONNECTOR 543-0309-002 (13499)	EA	2										
XI-H		ARM, CONNECTOR 543-0385-002 (13499)	EA	1										
XI-H		CONNECTOR, LINK 543-0308-002 (13499)	EA	2										
XI-H		HUB, LINK, ARM 543-0384-002 (13499)	EA	1										
A-H		ARM, CONNECTOR 544-7225-002 (13499)	EA	1										
XI-H		POST, CONNECTOR 543-0309-002 (13499)	EA	REF										
XI-H		ARM, CONNECTOR 543-0315-002 (13499)	EA	1										
XI-H		CONNECTOR, LINK 543-0308-002 (13499)	EA	REF										
XI-H		HUB, LINK, ARM 543-0307-002 (13499)	EA	1										
A-F		RESISTOR ASSEMBLY 543-3266-002 (13499)	EA	1										1A3TB3
P-H	5820-813-0737	TERMINAL BOARD 543-3265-002 (13499)	EA	1				*	*	*	*	*		
XI-H		TERMINAL BOARD 543-3263-002 (13499)	EA	1										
P-F	5940-159-0236	TERMINAL, STUD 1969C (71279)	EA	14	*	*	*	*	*	*	*	*		
P-F	5905-254-7101	RESISTOR, FIXED, COMPOSITION RC42GF104J (81349)	EA	6	*	*	*	*	*	*	*	*	3-37	1A3R30
P-F	5905-254-7101	RESISTOR, FIXED, COMPOSITION RC42GF104J (81349)	EA	REF	*	*	*	*	*	*	*	*	3-37	1A3R31
P-F	5905-254-7101	RESISTOR, FIXED, COMPOSITION RC42GF104J (81349)	EA	REF	*	*	*	*	*	*	*	*	3-37	1A3R32
P-F	5905-254-7101	RESISTOR, FIXED, COMPOSITION RC42GF1C4J (81349)	EA	REF	*	*	*	*	*	*	*	*	3-37	1A3R33
P-F	5905-254-7101	RESISTOR, FIXED, COMPOSITION RC42GF104J (81349)	EA	REF	*	*	*	*	*	*	*	*	3-37	1A3R34
P-F	5905-254-7101	RESISTOR, FIXED, COMPOSITION RC42GF104J (81349)	EA	REF	*	*	*	*	*	*	*	*	3-37	1A3R35
M-H		WIRE, ELECTRICAL 00702-1320 (70567)	FT	REF										
A-F		DISTRIBUTION BOX 543-0426-003 (13499)	EA	1										
P-H		WASHER, LOCK 310-0076-000 (79807)	EA	REF				*	*	*	*	*		
M-H		INSULATION SLEEVING, ELECTRICAL TEPTW20B (81851)	FT	REF										
P-F		SCREW, MACHINE P343-1563-000 (77250)	EA	4	*	*	*	*	*	*	*	*		
P-F		NUT, PLAIN, HEXAGON P313-0149-000 (77250)	EA	REF	*	*	*	*	*	*	*	*		
P-F		SCREW, MACHINE P342-0152-000 (77250)	EA	REF	*	*	*	*	*	*	*	*		
P-F		SCREW, MACHINE P343-0286-000 (77250)	EA	REF	*	*	*	*	*	*	*	*		

SECTION III REPAIR PARTS FOR DIRECT SUPPORT, GENERAL SUPPORT, AND DEPOT MAINTENANCE (CONTINUED)

(1) SNR CODE	(2) FEDERAL STOCK NUMBER	(3) DESCRIPTION  USABLE ON CODE	(4) UNIT OF MEAS	(5) QTY INC IN UNIT	(6) 30-DAY DS MAINT ALLOWANCE			(7) 30-DAY GS MAINT ALLOWANCE			(8) 1 YR ALW PER EQUIP CNTGTY	(9) DEPOT MAINT ALW PER 100 EQUIP	(10) ILLUSTRATIONS	
					(a) 1-20	(b) 21-50	(c) 51-100	(a) 1-20	(b) 21-50	(c) 51-100			(a) FIG NO.	(b) ITEM NO. OR REFERENCE DESIGNATION
P-F	5935-284-3931	CONNECTOR, RECEPTACLE, ELECTRICAL U0931U (80058)	EA	1	*	*	*	*	*	*	*	*	3-38	1A3J3
P-F	5935-204-7705	CONNECTOR, RECEPTACLE, ELECTRICAL 26-4401-16S (02660)	EA	1	*	*	*	*	*	*	*	*	3-38	1A3J6
P-F		WASHER, LOCK 1714-05CADPL (78189)	EA	REF	*	*	*	*	*	*	*	*		
P-H		TERMINAL, LUG 2104-04-01-252N (78189)	EA	REF	*	*	*	*	*	*	*	*		
P-F		NUT, PLAIN, HEXAGON P313-0051-000 (77250)	EA	REF	*	*	*	*	*	*	*	*		
P-H	5305-616-2568	SCREW, MACHINE P343-0285-000 (77250)	EA	REF	*	*	*	*	*	*	*	*		
A-H		CABLE, ASSEMBLY, RADIO FREQUENCY 543-0390-002 (13499)	EA	1	*	*	*	*	*	*	*	*		
P-H		SHIELD, ELECTRICAL CONNECTOR MK195U (81349)	EA	1	*	*	*	*	*	*	*	*		
M-H		CABLE, RADIO FREQUENCY RG58CU (80058)	FT	63	*	*	*	*	*	*	*	*		
P-F	5935-810-3767	CONNECTOR, RECEPTACLE, ELECTRICAL U0909BU (80058)	EA	1	*	*	*	*	*	*	*	*	3-38	1A3J1
P-F	5910-615-4101	CAPACITOR, FIXED, CERAMIC DIELECTRIC 327-029X5T0102Z (72982)	EA	21	*	*	*	*	*	*	*	*	3-38	1A3057
P-F	5910-615-4101	CAPACITOR, FIXED, CERAMIC DIELECTRIC 327-029X5T0102Z (72982)	EA	REF	*	*	*	*	*	*	*	*	3-38	1A3058
P-F	5910-615-4101	CAPACITOR, FIXED, CERAMIC DIELECTRIC 327-029X5T0102Z (72982)	EA	REF	*	*	*	*	*	*	*	*	3-38	1A3059
P-F	5910-615-4101	CAPACITOR, FIXED, CERAMIC DIELECTRIC 327-029X5T0102Z (72982)	EA	REF	*	*	*	*	*	*	*	*	3-38	1A3060
P-F	5910-615-4101	CAPACITOR, FIXED, CERAMIC DIELECTRIC 327-029X5T0102Z (72982)	EA	REF	*	*	*	*	*	*	*	*	3-38	1A3061
P-F	5910-615-4101	CAPACITOR, FIXED, CERAMIC DIELECTRIC 327-029X5T0102Z (72982)	EA	REF	*	*	*	*	*	*	*	*	3-38	1A3062
P-F	5910-615-4101	CAPACITOR, FIXED, CERAMIC DIELECTRIC 327-029X5T0102Z (72982)	EA	REF	*	*	*	*	*	*	*	*	3-38	1A3063
P-F	5910-615-4101	CAPACITOR, FIXED, CERAMIC DIELECTRIC 327-029X5T0102Z (72982)	EA	REF	*	*	*	*	*	*	*	*	3-38	1A3064
P-F	5910-615-4101	CAPACITOR, FIXED, CERAMIC DIELECTRIC 327-029X5T0102Z (72982)	EA	REF	*	*	*	*	*	*	*	*	3-38	1A3065
P-F	5910-615-4101	CAPACITOR, FIXED, CERAMIC DIELECTRIC 327-029X5T0102Z (72982)	EA	REF	*	*	*	*	*	*	*	*	3-38	1A3066
P-F	5910-615-4101	CAPACITOR, FIXED, CERAMIC DIELECTRIC 327-029X5T0102Z (72982)	EA	REF	*	*	*	*	*	*	*	*	3-38	1A3067
P-F	5910-615-4101	CAPACITOR, FIXED, CERAMIC DIELECTRIC 327-029X5T0102Z (72982)	EA	REF	*	*	*	*	*	*	*	*	3-38	1A3068
X1-F		RETAINER, CAPACITOR 544-2723-002 (13499)	EA	1	*	*	*	*	*	*	*	*		
X2-F		BRACKET, TERMINAL 544-2726-003 (13499)	EA	1	*	*	*	*	*	*	*	*		
X2-F		BRACKET, TERMINAL 544-2725-003 (13499)	EA	1	*	*	*	*	*	*	*	*		
P-F	5310-596-6462	NUT, SELF-LOCKING, CLINCH 68NC3-4D (72962)	EA	6	*	*	*	*	*	*	*	*		
M-H		INSULATION SLEEVING, ELECTRICAL TEPTW13B (81851)	FT	REF	*	*	*	*	*	*	*	*		

SECTION III REPAIR PARTS FOR DIRECT SUPPORT, GENERAL SUPPORT, AND DEPOT MAINTENANCE (CONTINUED)

(1) SR CODE	(2) FEDERAL STOCK NUMBER	(3) DESCRIPTION  REFERENCE NUMBER & MFR. CODE	(4) UNIT OF MEAS	(5) QTY INC IN UNIT	(6) 30-DAY DS MAINT ALLOWANCE			(7) 30-DAY GS MAINT ALLOWANCE			(8) 1 YR ALW PER EQUIP CNTGCTY	(9) DEPOT MAINT ALW PER 100 EQUIP	(10) ILLUSTRATIONS	
					(a) 1-20	(b) 21-50	(c) 51-100	(a) 1-20	(b) 21-50	(c) 51-100			(a) FIG NO.	(b) ITEM NO. OR REFERENCE DESIGNATION
M-H		WIRE, ELECTRICAL 00702-1322 (70567)	FT	REF										
M-H		WIRE, ELECTRICAL MILF16878TYPER22-9 (81349)	FT	REF										
M-H		WIRE, ELECTRICAL MILF16878TYPER22-30 (81349)	FT	REF										
M-H		WIRE, ELECTRICAL MILF16878TYPER22-91 (81349)	FT	REF										
M-H		WIRE, ELECTRICAL MILF16878TYPER22-91 (81349)	FT	REF										
M-H		WIRE, ELECTRICAL MILF16878TYPER22-93 (81349)	FT	REF										
M-H		WIRE, ELECTRICAL MILF16878TYPER22-95 (81349)	FT	REF										
M-H		WIRE, ELECTRICAL MILF16878TYPER22-903 (81349)	FT	REF										
M-H		WIRE, ELECTRICAL MILF16878TYPER22-905 (81349)	FT	REF										
M-H		WIRE, ELECTRICAL MILF16878TYPER22-915 (81349)	FT	REF										
M-H		WIRE, ELECTRICAL MILF16878TYPER22-916 (81349)	FT	REF										
M-H		WIRE, ELECTRICAL MILF16878TYPER22-925 (81349)	FT	REF										
M-H		WIRE, ELECTRICAL MILF16878TYPER22-926 (81349)	FT	REF										
P-H		WIRE, ELECTRICAL MILF16878TYPER22-9256 (81349)	FT	REF				*	*	*	*	*		
P-H		WASHER, LOCK 310-0395-000 (79897)	EA	REF				*	*	*	*	*		
P-F		TERMINAL, LUG 4012BOTTINNED (77146)	EA	3	*	*	*	*	*	*	*	*		
P-F	5950-583-0953	COIL, RADIO FREQUENCY 543-0460-003 (13499)	EA	1	*	*	*	*	*	*	*	*	3-37	1A3L9
XI-H		FORM, COIL E49179 (70371)	EA	1										
P-F		WASHER, NONMETALLIC 302-4000-000 (74921)	EA	3	*	*	*	*	*	*	*	*		
XI-F		TERMINAL, LUG 4040-2BOTTINNED (77147)	EA	REF										
P-F		NUT, PLAIN, HEXAGON P313-0050-000 (77250)	EA	5	*	*	*	*	*	*	*	*		
P-F		SCREW, MACHINE P343-0300-000 (77250)	EA	3	*	*	*	*	*	*	*	*		
M-H		WIRE, ELECTRICAL ISALITE27WG (19728)	FT	41										
P-F		SCREW, MACHINE P343-0328-000 (77250)	EA	REF	*	*	*	*	*	*	*	*		
XI-F		TERMINAL, LUG 506-7407-002 (13499)	EA	1										
P-F		WASHER, NONMETALLIC 302-0025-000 (05284)	EA	25	*	*	*	*	*	*	*	*		
P-F		WASHER, NONMETALLIC 302-3900-000 (74921)	EA	3	*	*	*	*	*	*	*	*		

SECTION III REPAIR PARTS FOR DIRECT SUPPORT, GENERAL SUPPORT, AND DEPOT MAINTENANCE (CONTINUED)

(1) SPR CODE	(2) FEDERAL STOCK NUMBER	(3) DESCRIPTION  REFERENCE NUMBER & MFR. CODE	(4) UNIT OF MEAS	(5) QTY REQ IN UNIT	(6) 30-DAY DS MAINT ALLOWANCE			(7) 30-DAY GS MAINT ALLOWANCE			(8) 1 YR ALW PER EQUIP CATGCT	(9) DEPOT MAINT ALW PER 100 EQUIP	(10) ILLUSTRATIONS	
					(a) 1-20	(b) 21-50	(c) 51-100	(a) 1-20	(b) 21-50	(c) 51-100			(a) FIG NO.	(b) ITEM NO. OR REFERENCE DESIGNATION
P-F	5950-615-0607	COIL, RADIO FREQUENCY 543-0497-003 (13499)	EA	1	*	*	*	*	*	*	*	*	3-37	1A3L8
XI-H		FORM, COIL E49185 (70371)	EA	1										
P-F		WASHER, NONMETALLIC 302-4000-000 (74921)	EA	REF	*	*	*	*	*	*	*	*		
XI-F		TERMINAL, LUG 4040-2HOTINNED (77147)	EA	REF										
P-F		NUT, PLAIN, HEXAGON P313-0050-000 (77250)	EA	REF	*	*	*	*	*	*	*	*		
P-F		SCREW, MACHINE P343-0300-000 (77250)	EA	REF	*	*	*	*	*	*	*	*		
M-H		WIRE, ELECTRICAL 1SALITE27AWG (19728)	FT	REF										
P-F		WASHER, NONMETALLIC 302-3900-000 (74921)	EA	REF	*	*	*	*	*	*	*	*		
P-F	5950-679-9334	COIL, RADIO FREQUENCY 543-0316-002 (13499)	EA	1	*	*	*	*	*	*	*	*	3-37	1A3L11
XI-H		FORM, COIL E49178 (70371)	EA	1										
M-H		WIRE, ELECTRICAL ANALAC22AWG (81554)	FT	9										
P-F		TERMINAL, LUG 2110-04-00 (78189)	EA	REF	*	*	*	*	*	*	*	*		
M-H		WASHER, NONMETALLIC 302-0024-000 (05284)	EA	REF										
P-H		WASHER, FLAT 310-0054-000 (79807)	EA	REF				*	*	*	*	*		
P-F		NUT, PLAIN, HEXAGON P313-0051-000 (77250)	EA	REF	*	*	*	*	*	*	*	*		
P-H		SCREW, MACHINE P343-0287-000 (77250)	EA	REF				*	*	*	*	*		
P-H		WASHER, FLAT 506-5902-003 (13499)	EA	REF				*	*	*	*	*		
P-F	5821-708-6115	DUCT, AIR 544-9112-002 (13499)	EA	2	*	*	*	*	*	*	*	*	3-37	1A3E3
P-F	5821-708-6115	DUCT, AIR 544-9112-002 (13499)	EA	REF	*	*	*	*	*	*	*	*	3-37	1A3E4
XI-F		RIVET, TUBULAR R3484X7-32NI (12014)	EA	2										
X2-F		BRACKET, MOUNTING 543-0443-002 (13499)	EA	4										
XI-F		DUCT, AIR 544-9111-002 (13499)	EA	2										
P-F	5340-700-2314	TUBE, AIR, DUCT 544-9115-003 (13499)	EA	2	*	*	*	*	*	*	*	*		
P-F	5330-684-5119	CAP, VENT 543-0445-002 (13499)	EA	2	*	*	*	*	*	*	*	*		
X2-F		HOOK, RETAINING 544-9110-002 (13499)	EA	4										
XI-F		CONTACT, ELECTRICAL 544-9114-003 (13499)	EA	2										
XI-F		RIVET, TUBULAR 307-0059-000 (12014)	EA	16										



SECTION III REPAIR PARTS FOR DIRECT SUPPORT, GENERAL SUPPORT, AND DEPOT MAINTENANCE (CONTINUED)

(1) SIC CODE	(2) FEDERAL STOCK NUMBER	(3) DESCRIPTION  REFERENCE NUMBER & MFR. CODE	USABLE ON CODE	(4) UNIT OF MEAS	(5) QTY (INC IN UNIT	(6) 30-DAY DS MAINT ALLOWANCE			(7) 30-DAY GS MAINT ALLOWANCE			(8) 1 YR ALY PER EQUIP CATGRY	(9) DEPOT MAINT ALY PER 100 EQUIP	(10) ILLUSTRATIONS		
						(a) 1-20	(b) 21-60	(c) 61-100	(a) 1-20	(b) 21-60	(c) 61-100			(a) FIG NO.	(b) ITEM NO. OR REFERENCE DESIGNATION	
X2-F		PLATE, RETAINING 45-9058-002 (13499)		EA	4											
X2-F		LIVET, TUBULAR 3484X-16N1 (12014)		EA	REF											
A-F		RECTIFIER ASSEMBLY 153-7191-003 (13499)		EA	1											
P-F	5910-815-3907	CAPACITOR, FIXED, ELECTROLYTIC 183-1601-000 (00656)		EA	1	*	*	*	*	*	*	*	3-37	1A3C54		
P-F	5910-925-8882	CAPACITOR, FIXED, ELECTROLYTIC X13C240K (81349)		EA	1	*	*	*	*	*	*	*	3-37	1A3C53		
P-F	5305-777-6039	SCREW, MACHINE MS1957-12 (96906)		EA	REF	*	*	*	*	*	*	*				
P-F	5305-054-5646	SCREW, MACHINE MS1957-12 (96906)		EA	REF	*	*	*	*	*	*	*				
P-F	5961-688-6316	SEMICONDUCTOR DEVICE, DIODE 1N1095 (07688)		EA	1	*	*	*	*	*	*	*	3-37	1A3CR1		
P-F	5310-058-2949	WASHER, LOCK MS3537-78 (96906)		EA	REF	*	*	*	*	*	*	*				
P-F	5940-259-8457	TERMINAL, STUD RYM12M (91663)		EA	29	*	*	*	*	*	*	*				
P-F	5310-061-9245	POST, SPACING 540-9037-003 (13499)		EA	3	*	*	*	*	*	*	*				
A-H		PLATE, MOUNTING 553-7193-003 (13499)		EA	1											
X2-H		PLATE, MOUNTING 553-7192-003 (13499)		EA	1											
P-F	5310-050-6833	NUT, SELF-LOCKING, CLINCH F22NCPM1-40 (72962)		EA	REF	*	*	*	*	*	*	*				
X1-F		RETAINER, CAPACITOR 553-7194-003 (13499)		EA	1											
P-F	5905-752-7450	RESISTOR, FIXED, WIRE WOUND 710-3855-000 (83827)		EA	1	*	*	*	*	*	*	*	3-37	1A3R18		
P-F	5905-106-9344	RESISTOR, FIXED, COMPOSITION RC20GF10LJ (81349)		EA	1	*	*	*	*	*	*	*	3-37	1A3R17		
M-H		WIRE, ELECTRICAL 00702-1320 (70967)		FT	REF											
A-F		AMPLIFIER SUBASSEMBLY 543-0429-003 (13499)		EA	1											
P-F	5820-811-7677	TERMINAL BOARD 543-0304-002 (13499)		EA	1	*	*	*	*	*	*	*	3-37	1A3TB1		
X1-F		TERMINAL BOARD 543-0303-002 (13499)		EA	1											
X1-F		TERMINAL, STUD 502-1383-002 (13499)		EA	18											
P-F	5905-254-7101	RESISTOR, FIXED, COMPOSITION RC42GF104J (81349)		EA	1	*	*	*	*	*	*	*	3-37	1A3R15		
P-F	5905-257-0937	RESISTOR, FIXED, COMPOSITION RC42GF472J (81349)		EA	1	*	*	*	*	*	*	*	3-37	1A3R20		
P-F		RESISTOR, FIXED, COMPOSITION RC20GF823K (81349)		EA	1	*	*	*	*	*	*	*	3-37	1A3R21		
P-H	5905-195-6758	RESISTOR, FIXED, COMPOSITION RC20GF273K (81349)		EA	1				*	*	*	*	3-37	1A3R23		
P-H	5905-192-3987	RESISTOR, FIXED, COMPOSITION RC20GF104K (81349)		EA	1				*	*	*	*	3-37	1A3R29		

SECTION III REPAIR PARTS FOR DIRECT SUPPORT, GENERAL SUPPORT, AND DEPOT MAINTENANCE (CONTINUED)

(1) SIC CODE	(2) FEDERAL STOCK NUMBER	(3) DESCRIPTION  REFERENCE NUMBER & MFR. CODE	(4) UNIT OF MEAS	(5) QTY INC IN UNIT	(6) 30-DAY GS MAINT ALLOWANCE			(7) 30-DAY GS MAINT ALLOWANCE			(8) 1 YR SALV PER EQUIP CONTRY	(9) DEPOT MAINT ALF PER 100 EQUIP	(10) ILLUSTRATIONS	
					(a)	(b)	(c)	(a)	(b)	(c)			(a)	(b)
					1-30	31-60	61-100	1-30	31-60	61-100			FIG NO.	ITEM NO. OR REFERENCE DESIGNATION
P-H	5961-543-0490	SEMICONDUCTOR DEVICE, DIODE 1M459 (07688)	EA	2				*	*	*	*	3-37	1A3C22	
P-H	5961-543-0490	SEMICONDUCTOR DEVICE, DIODE 1M459 (07688)	EA	REF				*	*	*	*	3-37	1A3C23	
P-F	5910-822-5683	CAPACITOR, FIXED, CERAMIC DIELECTRIC CM63M102M (81349)	EA	4	*	*	*	*	*	*	*	3-37	1A3C51	
M-H		WIRE, ELECTRICAL 00702-1322 (70567)	FT	REF										
M-H		INSULATION SLEEVING, ELECTRICAL SVH22-16-1 (81891)	FT	2										
P-H	5905-106-9345	RESISTOR, FIXED, COMPOSITION RC200P68J (81349)	EA	1				*	*	*	*	3-37	1A3R22	
A-F		CAPACITOR ASSEMBLY 543-0418-004 (13499)	EA	1										
P-H		WASHER, LOCK 110-0076-000 (79807)	EA	REF				*	*	*	*			
P-F		NUT, PLAIN, HEXAGON P313-0051-000 (79807)	EA	REF	*	*	*	*	*	*	*			
P-F		SCREW, MACHINE P342-0151-000 (77250)	EA	16	*	*	*	*	*	*	*			
P-H	5305-616-2568	SCREW, MACHINE P343-0285-000 (77250)	EA	REF				*	*	*	*			
P-F	5910-542-7377	CAPACITOR, FIXED, MICA DIELECTRIC 678508 (14674)	EA	1	*	*	*	*	*	*	*	3-37	1A3C30	
P-F	5910-818-0412	CAPACITOR, FIXED, MICA DIELECTRIC 678507 (14674)	EA	1	*	*	*	*	*	*	*	3-37	1A3C29	
P-F	5910-542-7379	CAPACITOR, FIXED, MICA DIELECTRIC 678509 (14674)	EA	1	*	*	*	*	*	*	*	3-37	1A3C31	
P-F	5910-814-9529	CAPACITOR, FIXED, MICA DIELECTRIC 678506 (14674)	EA	1	*	*	*	*	*	*	*	3-37	1A3C32	
XI-F		RETAINER, CAPACITOR 543-0407-003 (13499)	EA	1										
XI-F		RETAINER, CAPACITOR 543-0406-003 (13499)	EA	1										
P-F		NUT, CAPTIVE 543-0435-002 (13499)	EA	REF	*	*	*	*	*	*	*			
XI-F		STRAP, RETAINING 543-0322-002 (13499)	EA	1										
XI-F		RIVET, TUBULAR H4012X1-8PLAIN (12014)	EA	2										
XI-F		BOLT, EYE A24F4-789 (79251)	EA	2										
XI-F		STRAP, RETAINING 543-0323-002 (13499)	EA	1										
M-H		INSULATION SLEEVING, ELECTRICAL FLEXITETEFLOW3B (03890)	EA	1										
XI-F		LEAD, ELECTRICAL 543-0346-002 (13499)	EA	1										
XI-F		LEAD, ELECTRICAL 543-0347-002 (13499)	EA	1										
XI-F		LEAD, ELECTRICAL 543-0349-002 (13499)	EA	1										
XI-F		LEAD, ELECTRICAL 543-0351-002 (13499)	EA	1										

SECTION III REPAIR PARTS FOR DIRECT SUPPORT, GENERAL SUPPORT, AND DEPOT MAINTENANCE (CONTINUED)

(1) SIC CODE	(2) FEDERAL STOCK NUMBER	(3) DESCRIPTION  REFERENCE NUMBER & MFR. CODE	(4) USABLE ON CODE	(5) UNIT OF MEAS  QTY INC IN UNIT	(6) 30-DAY DS MAINT ALLOWANCE			(7) 30-DAY GS MAINT ALLOWANCE			(8) 1 YR ALY PER EQUIP CMTY	(9) DEPOT MAINT ALY PER 100 EQUIP	(10) ILLUSTRATIONS	
					(a) 1-20	(b) 21-50	(c) 51-100	(a) 1-20	(b) 21-50	(c) 51-100			(a) FIG NO.	(b) ITEM NO. OR REFERENCE DESIGNATION
X2-F		PLATE, MOUNTING 543-0352-002 (13499)		EA	8									
X2-F		PLATE, MOUNTING 543-0353-002 (13499)		EA	4									
X2-F		BLOCK, MOUNTING 543-0354-002 (13499)		EA	4									
X1-F		INSULATION SHEET, ELECTRICAL 543-0374-002 (13499)		EA	4									
P-H		CORD, NYLON 435-1014-000 (13499)		FT	REF				*	*	*	*		
X2-F		PLATE, MOUNTING, RELAY 543-3267-002 (13499)		EA	1									
P-H	5960-775-3080	CLAMP 544-9113-003 (13499)		EA	2				*	*	*	*	3-37	1A3E5
P-H	5960-775-3080	CLAMP 544-9113-003 (13499)		EA	REF				*	*	*	*	3-37	1A3E6
A-F		AMPLIFIER SUBASSEMBLY, SWITCH 543-0428-003 (13499)		EA	1									
P-F	5930-755-5835	SWITCH, ROTARY 18514772C (76854)		EA	1	*	*	*	*	*	*	*	3-38	1A3E4
P-F	5910-850-0541	CAPACITOR, FIXED, MICA DIELECTRIC VCM5E470J (72136)		EA	1	*	*	*	*	*	*	*	3-38	1A3C16
P-F	5910-264-9442	CAPACITOR, FIXED, MICA DIELECTRIC VCM5E271G (72136)		EA	1	*	*	*	*	*	*	*	3-38	1A3C17
P-F	5910-027-3054	CAPACITOR, FIXED, MICA DIELECTRIC CM15E311G (72136)		EA	1	*	*	*	*	*	*	*	3-38	1A3C18
P-F	5910-984-5253	CAPACITOR, FIXED, MICA DIELECTRIC VCM15E331G (72136)		EA	1	*	*	*	*	*	*	*	3-38	1A3C19
P-H	5905-993-2268	RESISTOR, FIXED, FILM RM65D2152F (81349)		EA	2	*	*	*	*	*	*	*	3-38	1A3E26
P-H	5905-993-2268	RESISTOR, FIXED, FILM RM65D2152F (81349)		EA	REF				*	*	*	*	3-38	1A3E28
P-F	5905-062-0537	RESISTOR, FIXED, FILM RM65D1102F (81349)		EA	1	*	*	*	*	*	*	*	3-38	1A3E27
M-H		WIRE, ELECTRICAL 00702-1320 (70567)		FT	REF									
M-H		INSULATION SLEEVING, ELECTRICAL SVHC2-16-1 (81891)		FT	REF									
A-F		CAPACITOR ASSEMBLY 543-0373-002 (13499)		EA	1									
X1-I		RETAINER, CAPACITOR 543-0369-002 (13499)		EA	1									
P-F	5910-990-6796	CAPACITOR, FIXED, MICA DIELECTRIC M23-1000M (53021)		EA	1	*	*	*	*	*	*	*	3-38	1A3C15
P-F	5930-679-9336	WHEEL, DETENT 543-0392-002 (13499)		EA	1	*	*	*	*	*	*	*		1A3M5
X1-I		DETENT, SWITCH M15409 (80079)		EA	1									
P-H		SCREW, MACHINE 543-0391-002 (13499)		EA	2				*	*	*	*		
P-F		SCREW, MACHINE P343-0328-000 (77250)		EA	REF	*	*	*	*	*	*	*		
P-F		WASHER, LOCK M53538-79 (96906)		EA	REF	*	*	*	*	*	*	*		

SECTION III REPAIR PARTS FOR DIRECT SUPPORT, GENERAL SUPPORT, AND DEPOT MAINTENANCE (CONTINUED)

(1) SIC CODE	(2) FEDERAL STOCK NUMBER	(3) DESCRIPTION  REFERENCE NUMBER & MFR. CODE	(4) UNIT OF MEAS	(5) QTY INC IN UNIT	(6) 30-DAY GS MAINT ALLOWANCE			(7) 30-DAY GS MAINT ALLOWANCE			(8) 1 HR MAN PER EQUIP CURRENCY	(9) DEPOT MAINT MAN PER 100 EQUIP	(10) FAC NO.	(11) ILLUSTRATION ITEM NO. OR REFERENCE DESIGNATION	
					(a) 1-20	(b) 21-60	(c) 61-100	(a) 1-20	(b) 21-60	(c) 61-100				(11a)	(11b)
					*	*	*	*	*	*					
P-F	5820-787-826	SETScrew 328-0020-000 (08664)	EA	REF	*	*	*	*	*	*	*				
P-F		DETENT, SWITCH 543-0432-003 (13499)	EA	1	*	*	*	*	*	*	*			1A3P6	
X1-F		DETENT, SWITCH 269-8421-000 (74217)	EA	1											
P-H		SCREW, MACHINE F342-0190-000 (77250)	EA	2				*	*	*	*				
X2-F		PLATE, MOUNTING 543-0383-002 (13499)	EA	1											
P-H		WASHER, FLAT 310-0037-000 (79807)	EA	4				*	*	*	*				
A-F		CABLE ASSEMBLY, RADIO FREQUENCY 543-0433-003 (13499)	EA	1											
P-F		5310+058-2949	WASHER, LOCK MS35337-78 (96906)	EA	REF	*	*	*	*	*	*	*			
P-F			NUT, PLAIN, HEXAGON P313-0132-000 (77250)	EA	REF	*	*	*	*	*	*	*			
P-F		5305-763-7822	SCREW, MACHINE MS51959-14 (96906)	EA	REF	*	*	*	*	*	*	*			
P-F	5935-974-541	CONNECTOR, RECEPTACLE, ELECTRICAL UG58AU (80058)	EA	1	*	*	*	*	*	*	*	3-36	1A3J2		
X1-F	5935-283-1207	SHIELD, ELECTRICAL, CONNECTOR UG177U (80058)	EA	1											
M-H		CABLE, RADIO FREQUENCY RG141AU (80058)	FT	1											
X2-F		BRACKET, ANGLE 544-7221-002 (13499)	EA	1											
X2-F		BRACKET, ANGLE 543-0313-002 (13499)	EA	1											
P-F		NUT, CAPTIVE NCH6-1-3 (07886)	EA	REF	*	*	*	*	*	*	*				
M-H		INSULATION SLEEVING, ELECTRICAL 152-2236-000 (13499)	FT	1											
P-F		CONNECTING, LINK 543-0310-002 (13499)	EA	1	*	*	*	*	*	*	*				
X1-F		SHAFT, STRAIGHT 543-0311-002 (13499)	EA	1								3-37	1A3P7		
X1-F		SHAFT, STRAIGHT 543-0305-002 (13499)	EA	1								3-37	1A3P8		
X2-F		BRACKET, ANGLE 543-0320-002 (13499)	EA	1											
X2-F		BLOCK, SPACER 543-0324-002 (13499)	EA	1											
X2-F		BRACKET, COIL 543-0325-002 (13499)	EA	1											
X1-F		RETAINER, CAPACITOR 543-0336-002 (13499)	EA	1											
X2-F		BLOCK, COIL 543-0357-002 (13499)	EA	2											
X2-F		BLOCK, COIL 543-0358-002 (13499)	EA	1											
X2-F		PLATE, ELECTRICAL 543-0345-002 (13499)	EA	1											

TM11-5820-555-24P  
SECTION III REPAIR PARTS FOR DIRECT SUPPORT, GENERAL SUPPORT, AND DEPOT MAINTENANCE (CONTINUED)

(1) SQR CODE	(2) FEDERAL STOCK NUMBER	(3) DESCRIPTION  REFERENCE NUMBER & MFR. CODE	(4) UNIT OF MEAS	(5) QTY REQ. IN UNIT	(6) 30-DAY GS MAINT ALLOWANCE			(7) 30-DAY GS MAINT ALLOWANCE			(8) 1 YR ALY PER EQUIP CATYCY	(9) DEPOT MAINT ALY PER 100 EQUIP	(10) ILLUSTRATIONS	
					(a) 1-20	(b) 21-50	(c) 51-100	(a) 1-20	(b) 21-50	(c) 51-100			(a) FIG NO.	(b) ITEM NO. OR REFERENCE DESIGNATION
P-H	5820-938-8295	STRAP, CONNECTOR 543-3268-002 (13499)	EA	2			*	*	*	*	*			
M-H		LEAD, ELECTRICAL 543-0337-002 (13499)	EA	1										
M-H		LEAD, ELECTRICAL 543-0339-002 (13499)	EA	1										
M-H		LEAD, ELECTRICAL 543-0340-002 (13499)	EA	1										
M-H		LEAD, ELECTRICAL 543-0341-002 (13499)	EA	1										
M-H		LEAD, ELECTRICAL 543-0342-002 (13499)	EA	1										
M-H		LEAD, ELECTRICAL 543-0343-002 (13499)	EA	1										
M-H		LEAD, ELECTRICAL 543-0344-002 (13499)	EA	1										
M-H		LEAD, ELECTRICAL 543-0343-002 (13499)	EA	1										
M-H		LEAD, ELECTRICAL 543-0350-002 (13499)	EA	1										
M-H		LEAD, ELECTRICAL 543-0355-002 (13499)	EA	1										
M-H		LEAD, ELECTRICAL 543-0356-002 (13499)	EA	1										
P-H		5821-676-2825	GASKET, COIL 543-0441-002 (13499)	EA	4			*	*	*	*	*		
M-H			LEAD, ELECTRICAL 544-7227-002 (13499)	EA	1									
P-F	TERMINAL, STUD 1985 (12615)		EA	REF	*	*	*	*	*	*	*			
M-H	LEAD, ELECTRICAL 543-0371-002 (13499)		EA	1										
M-H	LEAD, ELECTRICAL COIL 553-2668-003 (13499)		EA	1										
M-H	LEAD, ELECTRICAL 543-0379-002 (13499)		EA	1										
M-H	LEAD, ELECTRICAL 543-0380-002 (13499)		EA	1										
P-H	SPACER 543-0453-002 (13499)		EA	4				*	*	*	*	*		
M-H	LEAD, ELECTRICAL 543-0338-002 (13499)		EA	1										
A-F	SUPPRESSOR 543-0451-002 (13499)		EA	2								3-38	1A321	
A-F	SUPPRESSOR 543-0451-002 (13499)		EA	REF								3-38	1A322	
P-F	5905-279-2637		RESISTOR, FIXED, COMPOSITION RC32GF470K (81349)	EA	2	*	*	*	*	*	*	*		
M-H			WIRE, ELECTRICAL 00702-1318 (70567)	FT	REF									
M-H			INSULATION SLEEVING, ELECTRICAL 152-2250-000 (13499)	FT	2									
A-F		SUPPRESSOR 543-0452-002 (13499)	EA	2								3-37	1A323	

SECTION III REPAIR PARTS FOR DIRECT SUPPORT, GENERAL SUPPORT, AND DEPOT MAINTENANCE (CONTINUED)

(1) SQR CODE	(2) FEDERAL STOCK NUMBER	(3) DESCRIPTION  REFERENCE NUMBER & MFR. CODE	(4) UNIT OF MEAS	(5) QTY REQ OR UNIT	(6) 30-DAY GS MAINT ALLOWANCE			(7) 90-DAY GS MAINT ALLOWANCE			(8) # OF REPAIR EQUIP ENTRIES	(9) DEPOT MAINT PER 100 EQUIP	(10) FEB NO.	(11) ITEM NO. OR REFERENCE DESIGNATION
					(a) 1-30	(b) 31-60	(c) 61-100	(a) 1-30	(b) 31-60	(c) 61-100				
A-F		SUPPRESSOR 543-0432-002 (13499)	EA	REF										
P-F	5905-279-3527	RESISTOR, FIXED, COMPOSITION RC420F470K (81349)	EA	REF	*	*	*	*	*	*	*			
M-H		WIRE, ELECTRICAL 00702-1316 (70567)	FT	REF										
XI-		RING, TUBE MOUNTING 543-0442-002 (13499)	EA	2										
P-H		TERMINAL, LUG SPL4040-BOTTINERD (77147)	EA	REF				*	*	*	*			
P-H		TERMINAL, LUG 2104-04-01-2320W (78109)	EA	REF				*	*	*	*			
P-F	5940-321-5329	TERMINAL, LUG 3 (79963)	EA	1	*	*	*	*	*	*	*			
P-F	5940-205-6519	RING, RETAINING 5133-12C (79136)	EA	2	*	*	*	*	*	*	*			
P-F		SETScrew 4-48X1-86SPLINE416SST (08665)	EA	REF	*	*	*	*	*	*	*			
P-F	5940-259-8457	TERMINAL, STUD RMT12M (91663)	EA	REF	*	*	*	*	*	*	*			
P-F	5970-117-5189	INSULATOR, STANDOFF 2X783 (71990)	EA	1	*	*	*	*	*	*	*			
P-F		TERMINAL, STUD 504-7415-002 (13499)	EA	1	*	*	*	*	*	*	*			
M-H		CLAMP, LOOP HP6N (09922)	EA	REF										
P-F		TERMINAL, STUD 502-1375-002 (13499)	EA	1	*	*	*	*	*	*	*			
XI-		POST, MOUNTING RESISTOR F015-0553-000 (77250)	EA	2										
XI-		POST, SPACING 540-9033-003 (13499)	EA	4										
M-H		INSULATION SLEEVING, ELECTRICAL TEFTW9B (81851)	FT	REF										
M-H		INSULATION SLEEVING, ELECTRICAL TEFTW17B (81851)	FT	REF										
M-H		INSULATION SLEEVING, ELECTRICAL TEFTW20B (81851)	FT	REF										
M-D		PLATE, IDENTIFICATION 280-0490-000 (74048)	EA	REF										
P-H	3010-289-8593	COUPLING, SHAFT 39016 (76487)	EA	1				*	*	*	*	3-37	1A3M11	
P-F		NUT, PLAIN, HEXAGON P334-4120-000 (77250)	EA	REF	*	*	*	*	*	*	*			
P-F	5910-838-3556	CAPACITOR, FIXED, ELECTROLYTIC 71241 (56289)	EA	1	*	*	*	*	*	*	*	3-37	1A3C50	
P-F	5910-819-7095	CAPACITOR, FIXED, ELECTROLYTIC D25846 (56289)	EA	1	*	*	*	*	*	*	*	3-37	1A3C52	
P-F	5910-815-3907	CAPACITOR, FIXED, ELECTROLYTIC 183-1601-000 (00656)	EA	1	*	*	*	*	*	*	*	3-37	1A3C55	
P-F	5935-840-5485	SOCKET, ELECTRON 88-STM (02660)	EA	1	*	*	*	*	*	*	*	3-37	1A3XK1	
P-F	5935-729-7312	SOCKET, ELECTRON 7490-0189 (80368)	EA	2	*	*	*	*	*	*	*	3-38	1A3XV1	

SECTION III, REPAIR PARTS FOR DIRECT SUPPORT, GENERAL SUPPORT, AND DEPOT MAINTENANCE (CONTINUED)

(1) SR CODE	(2) FEDERAL STOCK NUMBER	(3) DESCRIPTION  REFERENCE NUMBER & MFR. CODE  USABLE ON CODE	(4) UNIT OF MEAS	(5) QTY INC IN UNIT	(6) 30-DAY DS MAINT ALLOWANCE			(7) 30-DAY GS MAINT ALLOWANCE			(8) 1 YR ALW PER EQUIP CHRGY	(9) DEPOT MAINT ALW PER 100 EQUIP	(10) ILLUSTRATIONS	
					(a)	(b)	(c)	(a)	(b)	(c)			(a) FIG NO.	(b) ITEM NO. OR REFERENCE DESIGNATION
					1-20	21-50	51-100	1-20	21-50	51-100				
P-F	5935-729-7312	SOCKET, ELECTRON 7490-0189 (80368)	EA	REF	*	*	*	*	*	*	*	3-38	1A3XV2	
P-F	5935-987-3551	SOCKET, ELECTRON SK620A (06980)	EA	2	*	*	*	*	*	*	*	3-38	1A3XV3	
P-F	5935-987-3551	SOCKET, ELECTRON SK620A (06980)	EA	REF	*	*	*	*	*	*	*	3-38	1A3XV4	
P-F	5950-237-1531	COIL, RADIO FREQUENCY 10205-3 (82142)	EA	3	*	*	*	*	*	*	*	3-38	1A3L5	
P-F	5950-237-1531	COIL, RADIO FREQUENCY 10205-3 (82142)	EA	REF	*	*	*	*	*	*	*	3-38	1A3L6	
P-F	5950-237-1531	COIL, RADIO FREQUENCY 10205-3 (82142)	EA	REF	*	*	*	*	*	*	*	3-38	1A3L7	
P-F	5950-845-6929	COIL, RADIO FREQUENCY 1537-92 (99800)	EA	3	*	*	*	*	*	*	*	3-38	1A3L5	
P-F	5950-845-6929	COIL, RADIO FREQUENCY 1537-92 (99800)	EA	REF	*	*	*	*	*	*	*	3-38	1A3L6	
P-F	5950-845-6929	COIL, RADIO FREQUENCY 1537-92 (99800)	EA	REF	*	*	*	*	*	*	*	3-38	1A3L7	
P-F	5950-796-3120	COIL, RADIO FREQUENCY 18-1117 (09290)	EA	1	*	*	*	*	*	*	*	3-38	1A3L3	
P-F	5950-796-3120	COIL, RADIO FREQUENCY 2500-42 (99800)	EA	1	*	*	*	*	*	*	*	3-38	1A3L3	
P-F	5950-990-0092	COIL, RADIO FREQUENCY L77K207 (81349)	EA	1	*	*	*	*	*	*	*	3-38	1A3L1	
M-H		INSULATION SLEEVING, ELECTRICAL TEPTW8B (81851)	FT	3										
P-F	5905-279-2643	RESISTOR, FIXED, COMPOSITION RC32GF101K (81349)	EA	REF	*	*	*	*	*	*	*			
M-H		INSULATION SLEEVING, ELECTRICAL TEPTW8B (81851)	FT	2										
P-F		TERMINAL, LUG 2104-06-02-2520N (78189)	EA	REF	*	*	*	*	*	*	*			
P-F	5905-258-6949	RESISTOR, FIXED, WIRE WOUND RW31V632 (81349)	EA	1	*	*	*	*	*	*	*	3-38	1A3R16	
P-F	5905-752-32653	RESISTOR, FIXED, WIRE WOUND RW31V152 (81349)	EA	1	*	*	*	*	*	*	*	3-38	1A3R9	
P-F	5910-938-1013	CAPACITOR, FIXED, MICA DIELECTRIC VCM150050K (72136)	EA	1	*	*	*	*	*	*	*	3-37	1A3C8	
P-F	5910-679-9322	CAPACITOR, FIXED, CERAMIC DIELECTRIC 808X70-501M (72982)	EA	1	*	*	*	*	*	*	*	3-38	1A3C9	
P-F	5910-192-2120	CAPACITOR, FIXED, CERAMIC DIELECTRIC 890S47Z (71590)	EA	4	*	*	*	*	*	*	*	3-37	1A3C11	
P-F	5910-192-2120	CAPACITOR, FIXED, CERAMIC DIELECTRIC 890S47Z (71590)	EA	REF	*	*	*	*	*	*	*	3-37	1A3C22	
P-F	5910-192-2120	CAPACITOR, FIXED, CERAMIC DIELECTRIC 890S47Z (71590)	EA	REF	*	*	*	*	*	*	*	3-37	1A3C23	
P-F	5910-192-2120	CAPACITOR, FIXED, CERAMIC DIELECTRIC 890S47Z (71590)	EA	REF	*	*	*	*	*	*	*	3-37	1A3C24	
P-F	5910-668-3647	CAPACITOR, FIXED, CERAMIC DIELECTRIC D8858-003 (71590)	EA	1	*	*	*	*	*	*	*	3-37	1A3C20	
P-F	5910-061-5427	CAPACITOR, FIXED, CERAMIC DIELECTRIC 890S12Z (71590)	EA	2	*	*	*	*	*	*	*	3-37	1A3C10	
P-F	5910-061-5427	CAPACITOR, FIXED, CERAMIC DIELECTRIC 890S12Z (71590)	EA	REF	*	*	*	*	*	*	*	3-37	1A3C33	

SECTION III, REPAIR PARTS FOR DIRECT SUPPORT, GENERAL SUPPORT, AND DEPOT MAINTENANCE (CONTINUED)

(1) SR CODE	(2) FEDERAL STOCK NUMBER	(3) DESCRIPTION  REFERENCE NUMBER & MFR. CODE	(4) UNIT OF MEAS	(5) QTY INC IN UNIT	(6) 30-DAY GS MAINT ALLOWANCE			(7) 30-DAY ES MAINT ALLOWANCE			(8) 1 YR ALUM PER EQUIP CATEGY	(9) DEPOT MAINT ALUM PER 100 EQUIP	(10) ILLUSTRATIONS	
					(a) 1-20	(b) 21-50	(c) 51-100	(a) 1-20	(b) 21-50	(c) 51-100			(a) FIG NO.	(b) ITEM NO. OR REFERENC DESIGNATION
P-F	5910-913-6383	CAPACITOR, FIXED, CERAMIC DIELECTRIC 850S75Z (71590)	EA	5	*	*	*	*	*	*	*	3-37	1A3C21	
P-F	5910-913-6383	CAPACITOR, FIXED, CERAMIC DIELECTRIC 850S75Z (71590)	EA	REF	*	*	*	*	*	*	*	3-37	1A3C25	
P-F	51910-913-6383	CAPACITOR, FIXED, CERAMIC DIELECTRIC 850S75Z (71590)	EA	REF	*	*	*	*	*	*	*	3-37	1A3C26	
P-F	5910-913-6383	CAPACITOR, FIXED, CERAMIC DIELECTRIC 850S75Z (71590)	EA	REF	*	*	*	*	*	*	*	3-37	1A3C27	
P-F	5910-913-6383	CAPACITOR, FIXED, CERAMIC DIELECTRIC 850S75Z (71590)	EA	REF	*	*	*	*	*	*	*	3-37	1A3C28	
P-F	5910-822-5683	CAPACITOR, FIXED, CERAMIC DIELECTRIC CK63AW103M (81349)	EA	REF	*	*	*	*	*	*	*	3-38	1A3C1	
P-F	5910-822-5683	CAPACITOR, FIXED, CERAMIC DIELECTRIC CK63AW103M (81349)	EA	REF	*	*	*	*	*	*	*	3-38	1A3C36	
P-F	5910-822-5683	CAPACITOR, FIXED, CERAMIC DIELECTRIC CK63AW103M (81349)	EA	REF	*	*	*	*	*	*	*	3-38	1A3C37	
P-H	5910-838-9421	CAPACITOR, FIXED, CERAMIC DIELECTRIC CK60AW102M (81349)	EA	3				*	*	*	*	3-38	1A3C2	
P-H	5910-838-9421	CAPACITOR, FIXED, CERAMIC DIELECTRIC CK60AW102M (81349)	EA	REF				*	*	*	*	3-38	1A3C3	
P-H	5910-838-9421	CAPACITOR, FIXED, CERAMIC DIELECTRIC CK60AW102M (81349)	EA	REF				*	*	*	*	3-38	1A3C6	
P-F	5910-615-4101	CAPACITOR, FIXED, CERAMIC DIELECTRIC 327-029X5T0102Z (72982)	EA	REF	*	*	*	*	*	*	*	3-37	1A3C39	
P-F	5910-615-4101	CAPACITOR, FIXED, CERAMIC DIELECTRIC 327-029X5T0102Z (72982)	EA	REF	*	*	*	*	*	*	*	3-37	1A3C40	
P-F	5910-615-4101	CAPACITOR, FIXED, CERAMIC DIELECTRIC 327-029X5T0102Z (72982)	EA	REF	*	*	*	*	*	*	*	3-38	1A3C42	
P-F	5910-615-4101	CAPACITOR, FIXED, CERAMIC DIELECTRIC 327-029X5T0102Z (72982)	EA	REF	*	*	*	*	*	*	*	3-38	1A3C45	
P-F	5910-615-4101	CAPACITOR, FIXED, CERAMIC DIELECTRIC 327-029X5T0102Z (72982)	EA	REF	*	*	*	*	*	*	*	3-38	1A3C46	
P-F	5910-615-4101	CAPACITOR, FIXED, CERAMIC DIELECTRIC 327-029X5T0102Z (72982)	EA	REF	*	*	*	*	*	*	*	3-38	1A3C47	
P-F	5910-615-4101	CAPACITOR, FIXED, CERAMIC DIELECTRIC 327-029X5T0102Z (72982)	EA	REF	*	*	*	*	*	*	*	3-37	1A3C56	
P-F	5910-615-4101	CAPACITOR, FIXED, CERAMIC DIELECTRIC 327-029X5T0102Z (72982)	EA	REF	*	*	*	*	*	*	*	3-37	1A3C69	
P-F	5910-615-4101	CAPACITOR, FIXED, CERAMIC DIELECTRIC 327-029X5T0102Z (72982)	EA	REF	*	*	*	*	*	*	*	3-37	1A3C74	
P-F	5910-615-0537	CAPACITOR, FIXED, CERAMIC DIELECTRIC 85C1 (01939)	EA	1	*	*	*	*	*	*	*	3-37	1A3C7	
P-F	5910-899-3164	CAPACITOR, VARIABLE 922-0528-000 (13499)	EA	1	*	*	*	*	*	*	*		1A3C12	
P-F	5945-230-2105	RELAY, ARMATURE 94-1551 (04221)	EA	1	*	*	*	*	*	*	*	3-37	1A3K2	
P-F	5950-986-3369	COIL, RADIO FREQUENCY 229-201-3 (74970)	EA	1	*	*	*	*	*	*	*	3-37	1A3L4	
P-F	5950-679-9333	COIL, RADIO FREQUENCY 544-7228-002 (13499)	EA	1	*	*	*	*	*	*	*	3-37	1A3L10	
P-F		NUT, CAPTIVE N6N6-2-2-1 (07886)	EA	REF	*	*	*	*	*	*	*			
P-F		COIL, RADIO FREQUENCY 229-202-4 (74970)	EA	1	*	*	*	*	*	*	*		1A3L16	



SECTION III, REPAIR PARTS FOR DIRECT SUPPORT, GENERAL SUPPORT, AND DEPOT MAINTENANCE (CONTINUED)

(1) SQR CODE	(2) FEDERAL STOCK NUMBER	(3) DESCRIPTION  REFERENCE NUMBER & MFR. CODE	(4) UNIT OF MEAS	(5) QTY INC IN UNIT	(6) 30-DAY DS MAINT ALLOWANCE			(7) 30-DAY GS MAINT ALLOWANCE			(8) 1 YR ALW PER EQUIP CNTGCT	(9) DEPOT MAINT ALW PER 100 EQUIP	(10) ILLUSTRATIONS	
					(a)	(b)	(c)	(a)	(b)	(c)			(a)	(b)
					1-20	21-50	51-100	1-20	21-50	51-100			FIG NO.	ITEM NO. OR REFERENCE DESIGNATION
XI-F		PLATE, SPACING 553-2667-002 (13499)	EA	1										
P-H		WASHER, FLAT 310-0037-000 (79807)	EA	REF				*	*	*	*			
P-F	5910-063-8424	CAPACITOR, FIXED, MICA DIELECTRIC DM10CL90J (72136)	EA	1	*	*	*	*	*	*	*	3-37	1A3C71	
P-F	5910-838-3860	CAPACITOR, FIXED, CERAMIC DIELECTRIC DA653-007 (71590)	EA	1	*	*	*	*	*	*	*	3-37	1A3C70	
P-F	5910-837-5109	CAPACITOR, FIXED, PAPER DIELECTRIC C224BKFI03 (81349)	EA	4	*	*	*	*	*	*	*	3-38	1A3C41	
P-F	5910-837-5109	CAPACITOR, FIXED, PAPER DIELECTRIC C224BKFI03 (81349)	EA	REF	*	*	*	*	*	*	*	3-38	1A3C43	
P-F	5910-837-5109	CAPACITOR, FIXED, PAPER DIELECTRIC C224BKFI03 (81349)	EA	REF	*	*	*	*	*	*	*	3-38	1A3C44	
P-F	5910-837-5109	CAPACITOR, FIXED, PAPER DIELECTRIC C224BKFI03 (81349)	EA	REF	*	*	*	*	*	*	*	3-38	1A3C48	
P-F	5910-846-4858	CAPACITOR, FIXED, PAPER DIELECTRIC JN17-255A (56289)	EA	1	*	*	*	*	*	*	*	3-37	1A3C49	
P-O	5960-615-0243	ELECTRON TUBE 6CL6 (86684)	EA	2	*	*	*	*	*	*	*	3-37	1A3V1	
P-O	5960-615-0243	ELECTRON TUBE 6CL6 (86684)	EA	REF	*	*	*	*	*	*	*	3-37	1A3V2	
P-F	5960-985-9019	ELECTRON TUBE 7580W4CX25CR (06980)	EA	2	*	*	*	*	*	*	*	3-38	1A3V3	
P-F	5960-985-9019	ELECTRON TUBE 7580W4CX25CR (06980)	EA	REF	*	*	*	*	*	*	*	3-38	1A3V4	
P-F	5930-636-1584	SWITCH, PUSH 1GAI9A1 (03497)	EA	1	*	*	*	*	*	*	*	3-38	1A3S10	
P-F	5905-859-7865	RESISTOR, VARIABLE K022661 (71450)	EA	1	*	*	*	*	*	*	*	3-37	1A3R19	
P-F	5945-259-0984	RELAY, THERMAL B2103 (19500)	EA	1	*	*	*	*	*	*	*	3-38	1A3K1	
P-F	5960-686-7500	SHIELD, ASSEMBLY 541-6555-003 (13499)	EA	2	*	*	*	*	*	*	*		1A3E1	
P-F	5960-686-7500	SHIELD, ASSEMBLY 541-6555-003 (13499)	EA	REF	*	*	*	*	*	*	*		1A3E2	
P-H	5960-581-2293	SHIELD, ELECTRON 195-0F1001 (91662)	EA	REF				*	*	*	*			
P-H	5960-865-5067	SHIELD ASSEMBLY 541-8165-002 (13499)	EA	REF				*	*	*	*			
P-H	5960-865-4501	SHIELD, TUBE 541-8162-002 (13499)	EA	REF				*	*	*	*			
XI-F		SHIELD 541-8162-012 (13499)	EA	REF				*	*	*	*			
P-F	5340-769-2243	SPRING, HELICAL 541-8164-002 (13499)	EA	REF	*	*	*	*	*	*	*			
P-H	5960-617-5785	RETAINER 541-6522-002 (13499)	EA	REF				*	*	*	*			
P-F	5950-679-9341	TRANSFORMER, POWER E10267 (87008)	EA	1	*	*	*	*	*	*	*	3-37	1A3T1	
P-F	5905-764-4869	RESISTOR, FIXED, FILM R470D1541P (81349)	EA	2	*	*	*	*	*	*	*	3-38	1A3R9	
P-F	5905-764-4969	RESISTOR, FIXED, FILM R470D1541P (81349)	EA	REF	*	*	*	*	*	*	*	3-38	1A3R10	

SECTION III REPAIR PARTS FOR DIRECT SUPPORT, GENERAL SUPPORT, AND DEPOT MAINTENANCE (CONTINUED)

(1) SAR CODE	(2) FEDERAL STOCK NUMBER	(3) DESCRIPTION  REFERENCE NUMBER & MFR. CODE	(4) UNIT OF MEAS	(5) QTY INC IN UNIT	(6) 30-DAY DS MAINT ALLOWANCE			(7) 30-DAY GS MAINT ALLOWANCE			(8) 1 YR ALM PER EQUIP CMTGTY	(9) DEPOT MAINT ALM PER 100 EQUIP	(10) ILLUSTRATIONS	
					(a) 1-20	(b) 21-50	(c) 51-100	(a) 1-20	(b) 21-50	(c) 51-100			(a) FIG NO.	(b) ITEM NO. OR REFERENCE DESIGNATION
P-F	5905-542-7638	RESISTOR, FIXED, WIRE WOUND RSM2R0700G (91637)	EA	1	*	*	*	*	*	*	*	3-38	1A3R14	
P-F	5905-542-7637	RESISTOR, FIXED, WIRE WOUND RS2-2R000F (91637)	EA	2	*	*	*	*	*	*	*	3-38	1A3R7	
P-F	5905-542-7637	RESISTOR, FIXED, WIRE WOUND RS2-2R000F (91637)	EA	REF	*	*	*	*	*	*	*	3-38	1A3R8	
P-H	5905-141-1118	RESISTOR, FIXED, COMPOSITION RC20GF990K (81349)	EA	1	*	*	*	*	*	*	*	3-38	1A3R3	
P-F	5905-279-2303	RESISTOR, FIXED, COMPOSITION RC42GF560K (81349)	EA	1	*	*	*	*	*	*	*	3-38	1A3R1	
P-F	5905-106-9344	RESISTOR, FIXED, COMPOSITION RC20GF101J (81349)	EA	2	*	*	*	*	*	*	*	3-38	1A3R13	
P-F	5905-106-9344	RESISTOR, FIXED, COMPOSITION RC20GF101J (81349)	EA	REF	*	*	*	*	*	*	*	3-38	1A3R24	
P-F	5905-295-3410	RESISTOR, FIXED, COMPOSITION RC20GF473K (81349)	EA	1	*	*	*	*	*	*	*	3-38	1A3R2	
P-F	5905-299-2054	RESISTOR, FIXED, COMPOSITION RC32GF221K (81349)	EA	1	*	*	*	*	*	*	*	3-38	1A3R6	
P-F	5905-279-1976	RESISTOR, FIXED, COMPOSITION RC42GF101K (81349)	EA	3	*	*	*	*	*	*	*	3-38	1A3R11	
P-F	5905-279-1976	RESISTOR, FIXED, COMPOSITION RC42GF101K (81349)	EA	REF	*	*	*	*	*	*	*	3-38	1A3R12	
P-F	5905-279-1976	RESISTOR, FIXED, COMPOSITION RC42GF101K (81349)	EA	REF	*	*	*	*	*	*	*	3-38	1A3R25	
P-F	5905-192-4505	RESISTOR, FIXED, COMPOSITION RC42GF822K (81349)	EA	1	*	*	*	*	*	*	*	3-38	1A3R4	
M-H		WIRE, ELECTRICAL MLW168781TYPED20-92 (81349)	FT	4										
M-H		BRAID, WIRE 36062 (75818)	FT	REF										
M-H		WIRE, ELECTRICAL 00702-1312 (70567)	FT	2										
M-H		WIRE, ELECTRICAL 00702-1314 (70567)	FT	4										
M-H		WIRE, ELECTRICAL 00702-1316 (70567)	FT	REF										
P-F	5940-636-7105	TERMINAL, LUG 1024-6HOTTINNED (77147)	EA	2	*	*	*	*	*	*	*			
P-F	5945-679-9554	RELAY, ARMATURE 11F-93550 (78277)	EA	1	*	*	*	*	*	*	*	3-38	1A3K3	
P-F	5970-082-0418	INSULATOR, STANDOFF E1700 (70371)	EA	2	*	*	*	*	*	*	*			
P-F	5310-631-1312	POST, SPACING 540-9209-003 (13499)	EA	1	*	*	*	*	*	*	*			
P-F	5905-279-1918	RESISTOR, FIXED, COMPOSITION RC42GF274K (81349)	EA	1	*	*	*	*	*	*	*	3-38	1A3R37	
P-F	5910-556-1425	CAPACITOR, FIXED, CERAMIC DIELECTRIC 33C2 (01939)	EA	2	*	*	*	*	*	*	*	3-38	1A3C4	
P-F	5910-556-1425	CAPACITOR, FIXED, CERAMIC DIELECTRIC 33C2 (01939)	EA	REF	*	*	*	*	*	*	*	3-38	1A3C5	
M-F		WIRE, ELECTRICAL 00702-1322 (70567)	FT	REF										
M-H		WIRE, ELECTRICAL 00702-1320 (70567)	FT	REF										

SECTION III REPAIR PARTS FOR DIRECT SUPPORT. GENERAL SUPPORT MD DEPOT MAINTENANCE (CONTINUED)

(1) S/R CODE	(2) FEDERAL STOCK NUMBER	(3) DESCRIPTION  REFERENCE NUMBER & MFR. CODE	(4) UNIT OF MEAS	(5) QTY INC. IN UNIT	(6) 30-DAY DS MAINT ALLOWANCE			(7) 30-DAY GS MAINT ALLOWANCE			(8) 1 YR ALW PER EQUIP CNTGTY	(9) DEPOT MAINT ALW PER 100 EQUIP	(10) ILLUSTRATIONS	
					(a) 1-20	(b) 21-50	(c) 51-100	(a) 1-20	(b) 21-50	(c) 51-100			(a) FIG NO.	(b) ITEM NO., OR REFERENCE DESIGNATION
M-H		WIRE, ELECTRICAL 00702-1318 (70567)	FT	REF										
P-F		WASHER, NONMETALLIC 302-0011-000 (13499)	EA	2	*	*	*	*	*	*	*	*		
P-F		WASHER, NONMETALLIC 302-0026-000 (05284)	EA	REF	*	*	*	*	*	*	*	*		
P-F		INSULATOR, WASHER 302-0348-000 (91500)	EA	REF	*	*	*	*	*	*	*	*		
P-F		TERMINAL, LUG 4007-6SHOTTINNE (77147)	EA	REF	*	*	*	*	*	*	*	*		
P-F		WASHER, FLAT 310-0056-000 (79807)	EA	REF	*	*	*	*	*	*	*	*		
P-H		WASHER, LOCK 310-0076-000 (79807)	EA	REF				*	*	*	*	*		
P-F	5310-209-6069	WASHER, LOCK 310-0077-000 (79807)	EA	REF	*	*	*	*	*	*	*	*		
P-F		WASHER, LOCK 310-0082-000 (79807)	EA	2	*	*	*	*	*	*	*	*		
P-F		WASHER, FLAT 310-0447-000 (79807)	EA	REF	*	*	*	*	*	*	*	*		
P-F	5310-907-0958	WASHER, FLAT 310-0045-000 (79807)	EA	REF	*	*	*	*	*	*	*	*		
P-F	5310-167-0837	WASHER, FLAT AN960-6161 (88044)	EA	1	*	*	*	*	*	*	*	*		
P-F		STUD, CONTINUOUS THREAD P312-3080-000 (77250)	EA	1	*	*	*	*	*	*	*	*		
P-F		NUT, PLAIN, HEXAGON MS35699-64 (96906)	EA	REF	*	*	*	*	*	*	*	*		
P-F		NUT, PLAIN, HEXAGON P313-0045-000 (77250)	EA	REF	*	*	*	*	*	*	*	*		
P-F		NUT, PLAIN, HEXAGON P313-0051-000 (77250)	EA	REF	*	*	*	*	*	*	*	*		
P-F		NUT, PLAIN, HEXAGON P313-0053-000 (77250)	EA	REF	*	*	*	*	*	*	*	*		
P-F		NUT, PLAIN, HEXAGON P313-0064-000 (77250)	EA	5	*	*	*	*	*	*	*	*		
P-F		NUT, PLAIN, HEXAGON P313-0132-000 (77250)	EA	REF	*	*	*	*	*	*	*	*		
P-F		NUT, PLAIN, HEXAGON P313-0140-000 (77250)	EA	REF	*	*	*	*	*	*	*	*		
P-F		NUT, PLAIN, HEXAGON P313-0156-000 (77250)	EA	REF	*	*	*	*	*	*	*	*		
P-F		SETScrew 328-0018-000 (13499)	EA	REF	*	*	*	*	*	*	*	*		
P-F		SETScrew 328-0507-010 (13499)	EA	REF	*	*	*	*	*	*	*	*		
P-F		NUT, PLAIN, HEXAGON P334-0254-000 (77250)	EA	REF	*	*	*	*	*	*	*	*		
P-F		NUT, PLAIN, HEXAGON P334-0259-000 (77250)	EA	10	*	*	*	*	*	*	*	*		
P-H		SCREW, MACHINE P343-0287-000 (77250)	EA	REF				*	*	*	*	*		
P-F		NUT, PLAIN, HEXAGON 334-0890-000 (21537)	EA	1	*	*	*	*	*	*	*	*		

SECTION III REPAIR PARTS FOR DIRECT SUPPORT, GENERAL SUPPORT, AND DEPOT MAINTENANCE (CONTINUED)

(1) SR CODE	(2) FEDERAL STOCK NUMBER	(3) DESCRIPTION  REFERENCE NUMBER & MFR. CODE	(4) UNIT OF MEAS	(5) QTY INC IN UNIT	(6) 30-DAY DS MAINT ALLOWANCE			(7) 30-DAY GS MAINT ALLOWANCE			(8) 1 YR ALM PER EQUIP CMTY	(9) DEPOT MAINT ALM PER 100 EQUIP	(10) ILLUSTRATIONS	
					(a) 1-20	(b) 21-60	(c) 61-100	(a) 1-20	(b) 21-60	(c) 61-100			(a) FIG NO.	(b) 17B. NO. OR REFERENCE DESIGNATION
P-F	5305-777-6039	SCREW, MACHINE MS51959-12 (96906)	EA	REF	*	*	*	*	*	*	*			
P-F	5305-763-7822	SCREW, MACHINE MS51959-14 (96906)	EA	REF	*	*	*	*	*	*	*			
P-F	5305-763-7827	SCREW, MACHINE MS51959-18 (96906)	EA	REF	*	*	*	*	*	*	*			
P-F		SCREW, MACHINE P342-0151-000 (77250)	EA	REF	*	*	*	*	*	*	*			
P-F		SCREW, MACHINE P342-0153-000 (77250)	EA	REF	*	*	*	*	*	*	*			
P-F		SCREW, MACHINE P342-0165-000 (77250)	EA	2	*	*	*	*	*	*	*			
P-F		SCREW, MACHINE P342-0168-000 (77250)	EA	REF	*	*	*	*	*	*	*			
P-F	5305-054-5646	SCREW, MACHINE MS51957-12 (96906)	EA	REF	*	*	*	*	*	*	*			
P-F	5305-054-5647	SCREW, MACHINE MS51957-13 (96906)	EA	REF	*	*	*	*	*	*	*			
P-F	5305-054-5648	SCREW, MACHINE MS51957-14 (96906)	EA	REF	*	*	*	*	*	*	*			
P-F	5305-054-6651	SCREW, MACHINE MS51957-27 (96906)	EA	REF	*	*	*	*	*	*	*			
P-F	5305-054-6653	SCREW, MACHINE MS51957-29 (96906)	EA	REF	*	*	*	*	*	*	*			
P-F		SCREW, MACHINE P343-0284-000 (77250)	EA	81	*	*	*	*	*	*	*			
P-H	5305-616-2568	SCREW, MACHINE P343-0285-000 (77250)	EA	REF	*	*	*	*	*	*	*			
P-F		SCREW, MACHINE P343-0327-000 (77250)	EA	20	*	*	*	*	*	*	*			
P-F		SCREW, MACHINE P343-0328-000 (77250)	EA	REF	*	*	*	*	*	*	*			
P-F		SCREW, MACHINE P343-0329-000 (77250)	EA	REF	*	*	*	*	*	*	*			
P-F		SCREW, MACHINE P343-0330-000 (77250)	EA	REF	*	*	*	*	*	*	*			
P-F		SCREW, MACHINE P343-0331-000 (77250)	EA	REF	*	*	*	*	*	*	*			
P-F		SCREW, MACHINE P343-0333-000 (77250)	EA	5	*	*	*	*	*	*	*			
P-F		WASHER, LOCK 1928-02-00-2480 (78189)	EA	1	*	*	*	*	*	*	*			
P-F	5310-184-9161	WASHER, LOCK MS39333-80 (96906)	EA	1	*	*	*	*	*	*	*			
P-F		WASHER, LOCK 1722-01CADPLATED (78189)	EA	REF	*	*	*	*	*	*	*			
P-F		WASHER, LOCK 1718-02CADPLATED (78189)	EA	REF	*	*	*	*	*	*	*			
P-F		WASHER, LOCK 1720-02CADPLATED (78189)	EA	REF	*	*	*	*	*	*	*			
P-F		WASHER, LOCK 1714-05CADPLATED (78189)	EA	REF	*	*	*	*	*	*	*			
P-F	5310-638-4552	WASHER, LOCK AN936A4B (88044)	EA	1	*	*	*	*	*	*	*			

SECTION III REPAIR PARTS FOR DIRECT SUPPORT, GENERAL SUPPORT, AND DEPOT MAINTENANCE (CONTINUED)

(1) SIB CODE	(2) FEDERAL STOCK NUMBER	(3) DESCRIPTION  REFERENCE NUMBER & MFR. CODE	(4) USABLE ON CODE	(5) UNIT OF MEAS	(6) QTY INC IN UNIT	(6) 30-DAY BS MAINT ALLOWANCE			(7) 30-DAY BS MAINT ALLOWANCE			(8) 1 YR ALW PER EQUIP CATGCT	(9) DEPOT MAINT ALW PER 100 EQUIP	(10) ILLUSTRATIONS	
						(a) 1-20	(b) 21-50	(c) 51-100	(a) 1-20	(b) 21-50	(c) 51-100			(a) FIG NO.	(b) ITEM NO. OR REFERENCE DESIGNATION
P-F	5310-167-0853	WASHER, LOCK AN936A6B (88044)		EA	26	*	*	*	*	*	*	*	*		
P-R	5310-559-7792	WASHER, LOCK AN936B4B (88044)		EA	REF				*	*	*	*	*		
P-F	5310-167-0847	WASHER, LOCK AN936B6B (88044)		EA	REF	*	*	*	*	*	*	*	*		
P-F	5310-209-1366	WASHER, LOCK MS35335-5E (96906)		EA	REF	*	*	*	*	*	*	*	*		
P-F		SPACER, SLEEVE 541-6021-002 (13499)		EA	1	*	*	*	*	*	*	*	*		
M-H		INSULATION SLEEVING, ELECTRICAL SVHC2-2-1 (81851)		FT	2										
A-H		SWITCH SUBASSEMBLY 544-7247-000 (13499)		EA	1										
M-H		WIRE, ELECTRICAL MILW16878TYPB22-923 (81349)		FT	REF										
M-H		WIRE, ELECTRICAL MILW16878TYPB22-912-3 (81349)		FT	REF										
P-H		WIRE, ELECTRICAL MILW16878TYPB22-9126 (81349)		FT	REF				*	*	*	*	*		
M-H		WIRE, ELECTRICAL MILW16878TYPB20-92 (81349)		FT	REF										
P-H		CORD, NYLON 435-1014-000 (13499)		FT	REF				*	*	*	*	*		
P-H	5930-679-9340	SWITCH, SENSITIVITY 543-0427-003 (13499)		EA	1				*	*	*	*	*	3-37	1A387
P-F	5970-082-0418	INSULATOR, STANDOFF K1700 (70371)		EA	REF	*	*	*	*	*	*	*	*		
P-F		WASHER, NONMETALIC 302-0026-000 (05284)		EA	REF	*	*	*	*	*	*	*	*		
P-F	5940-636-7105	TERMINAL, LUG 1024-6HOTTIMED (77147)		EA	REF	*	*	*	*	*	*	*	*		
P-F		WASHER, FLAT 310-0056-000 (79807)		EA	REF	*	*	*	*	*	*	*	*		
P-F		NUT, PLAIN, HEXAGON F113-0050-000 (77250)		EA	REF	*	*	*	*	*	*	*	*		
P-F		SCREW, MACHINE P343-0328-000 (77250)		EA	REF	*	*	*	*	*	*	*	*		
X1-		SCREW, MACHINE P343-0304-000 (77250)		EA	2										
X2-		BRACKET, INTERLOCK 543-0375-002 (13499)		EA	1										
X1-		RIVET, SOLID MS20426AD3-2 (96906)		EA	2										
X2-		BRACKET, INTERLOCK 543-0405-003 (13499)		EA	1										
X1-		SPRING, ELECTRICAL 543-0319-002 (13499)		EA	1										
X1-		SPRING, SPACER 543-0318-002 (13499)		EA	1										
P-H	5930-239-9088	SWITCH, SENSITIVITY CR1070CL30F3 (01526)		EA	1				*	*	*	*	*	3-37	1A388
X2-		PLATE, LOCATING 543-0381-002 (13499)		EA	1										

SECTION III REPAIR PARTS FOR DIRECT SUPPORT, GENERAL SUPPORT, AND DEPOT MAINTENANCE (CONTINUED)

(1) SR CODE	(2) FEDERAL STOCK NUMBER	(3) DESCRIPTION  REFERENCE NUMBER & MFR. CODE	(4) UNIT OF MEAS	(5) QTY REQ. IN UNIT	(6) 30-DAY DS MAINT ALLOWANCE			(7) 90-DAY GS MAINT ALLOWANCE			(8) 1 YR ALM PER EQUIP CATEGY	(9) DEPOT MAINT ALM PER 100 EQUIP	(10) ILLUSTRATIONS	
					(a) 1-20	(b) 21-50	(c) 51-100	(a) 1-20	(b) 21-50	(c) 51-100			(e) FIG. NO.	(d) ITEM NO. OR REFERENCE DESIGNATION
P-F	5930-239-9088	SCREW, MACHINE P342-0152-000 (77250)	EA	REF	*	*	*	*	*	*	*			
M-H		CABLE, SPECIAL PURPOSE, ELECTRICAL 15DUB730W92 (90484)	FT	REF										
M-H		WIRE, ELECTRICAL MILW16878TYPB22-90 (81349)	FT	REF										
A-R		CABLE ASSEMBLY 544-7245-000 (13499)	EA	1										
M-H		WIRE, ELECTRICAL MILW16878TYPB22-9 (81349)	FT	REF										
M-H		WIRE, ELECTRICAL MILW16878TYPB22-90 (81349)	FT	REF										
M-H		WIRE, ELECTRICAL MILW16878TYPB22-91 (81349)	FT	REF										
M-H		WIRE, ELECTRICAL MILW16878TYPB22-92 (81349)	FT	REF										
M-H		WIRE, ELECTRICAL MILW16878TYPB22-93 (81349)	FT	REF										
M-H		WIRE, ELECTRICAL MILW16878TYPB22-95 (81349)	FT	REF										
M-H		WIRE, ELECTRICAL MILW16878TYPB22-902 (81349)	FT	REF										
M-H		WIRE, ELECTRICAL MILW16878TYPB22-903 (81349)	FT	REF										
M-H		WIRE, ELECTRICAL MILW16878TYPB22-905 (81349)	FT	REF										
M-H		WIRE, ELECTRICAL MILW16878TYPB22-912 (81949)	FT	REF										
M-H		WIRE, ELECTRICAL MILW16878TYPB22-913 (81349)	FT	REF										
M-H		WIRE, ELECTRICAL MILW16878TYPB22-915 (81349)	FT	REF										
M-H		WIRE, ELECTRICAL MILW16878TYPB22-916 (81349)	FT	REF										
M-H		WIRE, ELECTRICAL MILW16878TYPB22-923 (81349)	FT	REF										
M-H		WIRE, ELECTRICAL MILW16878TYPB22-923 (81349)	FT	REF										
M-H		WIRE, ELECTRICAL MILW16878TYPB22-926 (81349)	FT	REF										
M-H		WIRE, ELECTRICAL MILW16878TYPB22-935 (81349)	FT	REF										
M-H		WIRE, ELECTRICAL MILW16878TYPB22-936 (81349)	FT	REF										
P-H		WIRE, ELECTRICAL MILW16878TYPB22-956 (81349)	FT	REF				*	*	*	*	*		
M-H		WIRE, ELECTRICAL MILW16878TYPB22-902-3 (81349)	FT	REF										
M-H		WIRE, ELECTRICAL MILW16878TYPB22-902-5 (81349)	FT	REF										
M-H		WIRE, ELECTRICAL MILW16878TYPB22-902-6 (81349)	FT	REF										
M-H		WIRE, ELECTRICAL MILW16878TYPB22-912-3 (81349)	FT	REF										

SECTION III REPAIR PARTS FOR DIRECT SUPPORT, GENERAL SUPPORT, AND DEPOT MAINTENANCE (CONTINUED)

(1) SIR CODE	(2) FEDERAL STOCK NUMBER	(3) DESCRIPTION  REFERENCE NUMBER & MFR. CODE	(4) UNIT OF MEAS  USABLE ON CODE	(5) QTY INC IN UNIT	(6) 30-DAY GS MAINT ALLOWANCE			(7) 30-DAY GS MAINT ALLOWANCE			(8) 1 YR ALM PER EQUIP CONTACT	(9) DEPOT MAINT ALM PER 100 EQUIP	(10) ILLUSTRATIONS	
					(a)	(b)	(c)	(a)	(b)	(c)			(a)	(b)
					1-20	21-50	51-100	1-20	21-50	51-100			FIG NO.	ITEM NO., OR REFERENCE DESIGNATION
P-H		WIRE, ELECTRICAL MILW16878TYPE22-9125 (81349)		FT	REF				*	*	*	*		
P-H		WIRE, ELECTRICAL MILW16878TYPE22-9126 (81349)		FT	REF				*	*	*	*		
P-H		WIRE, ELECTRICAL MILW16878TYPE22-9236 (81349)		FT	REF				*	*	*	*		
P-H		WIRE, ELECTRICAL MILW16878TYPE22-9256 (81349)		FT	REF				*	*	*	*		
P-H		WIRE, ELECTRICAL MILW16878TYPE22-9356 (81349)		FT	REF				*	*	*	*		
M-H		WIRE, ELECTRICAL MILW16878TYPE16-9 (81349)		FT	1									
M-H	5930-239-9088	WIRE, ELECTRICAL MILW16878TYPE16-95 (81349)		FT	2									
P-H		CORD, NYLON 435-1014-000 (13499)		FT	REF				*	*	*	*		
P-H		GROMMET, RUBBER MS35489-14 (96906)		EA	1				*	*	*	*		
M-H		CABLE, SPECIAL PURPOSE, ELECTRICAL 15UB08730W92 (90484)		FT	REF									
A-H		INSULATION SLEEVING, ELECTRICAL MILW16878TYPE22-96 (81349)		FT	REF									
A-E		CABLE ASSEMBLY 546-7246-000 (13499)		EA	1									
M-H		WIRE, ELECTRICAL MILW16878TYPE22-96 (81349)		FT	REF									
M-H		WIRE, ELECTRICAL MILW16878TYPE22-925 (81349)		FT	REF									
M-H		WIRE, ELECTRICAL MILW16878TYPE22-936 (81349)		FT	REF									
M-H		WIRE, ELECTRICAL MILW16878TYPE22-95 (81349)		FT	REF									
M-H		WIRE, ELECTRICAL MILW16878TYPE22-902-5 (81349)		FT	REF									
P-H		WIRE, ELECTRICAL MILW16878TYPE22-9125 (81349)		FT	REF				*	*	*	*		
P-H		WIRE, ELECTRICAL MILW16878TYPE22-9125 (81349)		FT	REF				*	*	*	*		
M-H		WIRE, ELECTRICAL MILW16878TYPE22-92 (81349)		FT	REF									
P-H		WIRE, ELECTRICAL 1720-02CANFL (78189)		FT	REF				*	*	*	*		
P-H		CORD, NYLON 435-1014-000 (13499)		FT	REF				*	*	*	*		
M-H		INSULATION SLEEVING, ELECTRICAL FLEXITEFLONGB (03890)		FT	REF									
M-H		WIRE, ELECTRICAL MILW16878TYPE22-91 (81349)		FT	REF									
M-H		WIRE, ELECTRICAL MILW16878TYPE22-90 (81349)		FT	REF									
P-F		NUT, PLAIN, SQUARE P334-0486-000 (77250)		EA	REF	*	*	*	*	*	*	*		
P-H		WASHER, FLAT 540-3022-003 (13499)		EA	8				*	*	*	*		

SECTION III REPAIR PARTS FOR DIRECT SUPPORT, GENERAL SUPPORT, AND DEPOT MAINTENANCE (CONTINUED)

(1) SQR CODE	(2) FEDERAL STOCK NUMBER	(3) DESCRIPTION  REFERENCE NUMBER & MFR. CODE	(4) UNIT OF MEAS	(5) QTY REQ IN UNIT	(6) 30-DAY GS MAINT ALLOWANCE			(7) 30-DAY GS MAINT ALLOWANCE			(8) 1 YR ALW PER EQUIP CATEG	(9) DEPOT MAINT ALW PER 100 EQUIP	(10) ILLUSTRATIONS	
					(a) 1-20	(b) 21-50	(c) 51-100	(a) 1-20	(b) 21-50	(c) 51-100			(a) FIG NO.	(b) ITEM NO. OR REFERENCE DESIGNATION
P-F	5310-058-2949	WASHER, LOCK MS35337-78 (96906)	EA	REF	*	*	*	*	*	*	*			
P-H	5905-114-5416	RESISTOR, FIXED, COMPOSITION RG20GF274K (81349)	EA	1				*	*	*	*	3-37	1A3R99	
P-H	5961-284-6516	SEMICONDUCTOR DEVICE, DIODE 1M198 (07688)	EA	1				*	*	*	*	3-37	1A3CR4	
A-F		SCREEN TAP ASSEMBLY 593-7197-003 (13499)	EA	1										
M-H		INSULATION SLEEVING, ELECTRICAL TEFW20B (81851)	FT	REF										
P-F	5930-797-7838	SWITCH, ROTARY 228730BF1 (76854)	EA	2	*	*	*	*	*	*	*	3-38	1A3S11	
P-F	5930-797-7838	SWITCH, ROTARY 228730BF1 (76854)	EA	REF	*	*	*	*	*	*	*	3-38	1A3S12	
M-H		WIRE, ELECTRICAL 00702-1320 (70567)	FT	REF										
X2-F		BRACKET, MOUNTING 553-7199-003 (13499)	EA	1										
X2-F		BRACKET 553-7198-003 (13499)	EA	1										
P-F	5310-050-6833	NUT, SELF-LOCKING, CLINCH F22HCFM1-40 (72962)	EA	REF	*	*	*	*	*	*	*			
P-F	5905-088-0635	RESISTOR, FIXED, WIRE WOUND RW69V471 (81349)	EA	8	*	*	*	*	*	*	*	3-38	1A3R40	
P-F	5905-088-0635	RESISTOR, FIXED, WIRE WOUND RW69V471 (81349)	EA	REF	*	*	*	*	*	*	*	3-38	1A3R41	
P-F	5905-088-0635	RESISTOR, FIXED, WIRE WOUND RW69V471 (81349)	EA	REF	*	*	*	*	*	*	*	3-38	1A3R42	
P-F	5905-088-0635	RESISTOR, FIXED, WIRE WOUND RW69V471 (81349)	EA	REF	*	*	*	*	*	*	*	3-38	1A3R43	
P-F	5905-088-0635	RESISTOR, FIXED, WIRE WOUND RW69V471 (81349)	EA	REF	*	*	*	*	*	*	*	3-38	1A3R44	
P-F	5905-088-0635	RESISTOR, FIXED, WIRE WOUND RW69V471 (81349)	EA	REF	*	*	*	*	*	*	*	3-38	1A3R45	
P-F	5905-088-0635	RESISTOR, FIXED, WIRE WOUND RW69V471 (81349)	EA	REF	*	*	*	*	*	*	*	3-38	1A3R46	
P-F	5905-088-0635	RESISTOR, FIXED, WIRE WOUND RW69V471 (81349)	EA	REF	*	*	*	*	*	*	*	3-38	1A3R47	
P-F		NUT, PLAIN, HEXAGON P313-0064-000 (77250)	EA	REF	*	*	*	*	*	*	*			
P-F		WASHER, LOCK 1720-02CADPLATED (78189)	EA	REF	*	*	*	*	*	*	*			
A-F		CONTROL ASSEMBLY 553-7200-003 (13499)	EA	1										
P-F	5950-878-2442	COIL, RADIO FREQUENCY 2500-62 (99800)	EA	1	*	*	*	*	*	*	*	3-37	1A3L12	
P-F		TERMINAL, LUG 2104-04-01-2520N (78189)	EA	REF	*	*	*	*	*	*	*			
P-F	5940-259-8457	TERMINAL, STUD RMT12M (91663)	EA	REF	*	*	*	*	*	*	*			
P-F		NUT, PLAIN, HEXAGON P313-0051-000 (77250)	EA	REF	*	*	*	*	*	*	*			
P-F		SCREW, MACHINE P342-0151-000 (77250)	EA	REF	*	*	*	*	*	*	*			



SECTION III REPAIR PARTS FOR DIRECT SUPPORT, GENERAL SUPPORT, AND DEPOT MAINTENANCE (CONTINUED)

(1) SIB CODE	(2) FEDERAL STOCK NUMBER	(3) DESCRIPTION  USABLE ON CODE	(4) UNIT OF MEAS	(5) QTY REQD IN UNIT	(6) 30-DAY DS MAINT ALLOWANCE			(7) 30-DAY GS MAINT ALLOWANCE			(8) 1 YR ALM PER EQUIP CMTG	(9) DEPOT MAINT ALM PER 100 EQUIP	(10) ILLUSTRATIONS	
					(a)	(b)	(c)	(a)	(b)	(c)			(a) FIG NO.	(b) ITEM NO. OR REFERENCE DESIGNATION
					1-20	21-50	51-100	1-20	21-50	51-100				
P-H	5305-957-7799	SCREW, MACHINE P343-0384-000 (77250)	EA	REF				*	*	*	*			
P-H	5961-866-0476	SEMICONDUCTOR DEVICE, DIODE 1M457 (07688)	EA	1				*	*	*	*		3-37	1A3CR6
P-P	5961-543-0490	SEMICONDUCTOR DEVICE, DIODE 1M459 (07688)	EA	1	*	*	*	*	*	*	*		3-37	1A3CR5
P-P	5905-030-2755	RESISTOR, VARIABLE, COMPOSITION RV2MAY8252B (81349)	EA	1	*	*	*	*	*	*	*		3-37	1A3R49
M-H		WIRE, ELECTRICAL 00702-1320 (70567)	FT	REF										
X2-P		BRACKET, MOUNTING 553-7202-003 (13499)	EA	1										
X2-P		BRACKET, MOUNTING 553-7201-003 (13499)	EA	1										1A3MP18
P-F	5310-050-6833	NUT, SELF-LOCKING, CLINCH F22NCPM1-40 (72962)	EA	REF	*	*	*	*	*	*	*			
P-P	5905-249-3663	RESISTOR, FIXED, COMPOSITION RC420P683K (81349)	EA	1	*	*	*	*	*	*	*		3-37	1A3R48
P-P	5910-556-1425	CAPACITOR, FIXED, CERAMIC DIELECTRIC 33C2 (01939)	EA	1	*	*	*	*	*	*	*		3-37	1A3C72
P-P	5910-061-7356	CAPACITOR, FIXED, CERAMIC DIELECTRIC 55C23 (56289)	EA	1	*	*	*	*	*	*	*		3-37	1A3C73
P-P	5310-058-2949	WASHER, LOCK ME35337-78 (96906)	EA	REF	*	*	*	*	*	*	*			
P-P		NUT, PLAIN, HEXAGON P313-0064-000 (77250)	EA	REF	*	*	*	*	*	*	*			
P-P		WASHER, LOCK 1720-02CADPLATED (78189)	EA	REF	*	*	*	*	*	*	*			
P-O		KIT, MOUNTING 341-1477-002 (13499)	EA	REF	*	*	*	*	*	*	*			
M-H		BAG, COTTON 024-0100-000 (13499)	EA	REF	*	*	*	*	*	*	*			
P-O	5310-054-1830	WASHER, LOCK ME35338-80 (96906)	EA	REF	*	*	*	*	*	*	*			
P-O		WASHER, FLAT 310-0167-000 (79807)	EA	REF	*	*	*	*	*	*	*			
P-O		WASHER, LOCK 310-0286-000 (13499)	EA	REF	*	*	*	*	*	*	*			
P-O	5305-579-3507	SCREW, MACHINE ME35216-40 (96906)	EA	REF	*	*	*	*	*	*	*			
P-O		SCREW, MACHINE P343-0247-000 (77250)	EA	REF	*	*	*	*	*	*	*			
P-P	5305-054-6654	SCREW, MACHINE ME51997-3D (96906)	EA	REF	*	*	*	*	*	*	*			
P-P	5305-719-5064	SCREW, MACHINE ME51999-3D (96906)	EA	REF	*	*	*	*	*	*	*			
P-P	5305-054-5650	SCREW, MACHINE ME51997-16 (96906)	EA	REF	*	*	*	*	*	*	*			
P-P	5310-275-1347	WASHER, FLAT 310-0046-000 (79807)	EA	REF	*	*	*	*	*	*	*			
P-P	5310-011-1041	WASHER, LOCK ME35338-79 (96906)	EA	REF	*	*	*	*	*	*	*			
M-H		INSULATION SLEEVING, ELECTRICAL TEPTW1A8 (81851)	FT	REF										

SECTION III REPAIR PARTS FOR DIRECT SUPPORT, GENERAL SUPPORT, AND DEPOT MAINTENANCE (CONTINUED)

(1) SR CODE	(2) FEDERAL STOCK NUMBER	(3) DESCRIPTION  REFERENCE NUMBER & MFR. CODE	(4) UNIT OF MEAS	(5) QTY INC IN UNIT	(6) 30-DAY DS MAINT ALLOWANCE			(7) 30-DAY GS MAINT ALLOWANCE			(8) 1 YR ALN PER EQUIP CENCY	(9) DEPOT MAINT ALN PER 400 EQUIP	(10) ILLUSTRATIONS	
					(a) 1-20	(b) 21-50	(c) 51-100	(a) 1-20	(b) 21-50	(c) 51-100			(a) FIG NO.	(b) ITEM NO. OR REFERENCE DESIGNATOR
P-F	5305-579-3511	SCREW, MACHINE MS35216-42 (96906)	EA	REF	*	*	*	*	*	*	*			
P-O	5310-054-1830	WASHER, LOCK MS35338-80 (96906)	EA	REF	*	*	*	*	*	*	*			
P-F	5310-209-1074	WASHER, FLAT 310-0048-000 (79807)	EA	REF	*	*	*	*	*	*	*			
P-H	5905-141-1073	RESISTOR, FIXED, COMPOSITION RC20GF564K (81349)	EA	1				*	*	*	*	3-36	1A3E36	
P-H		WIRE, ELECTRICAL MILW16878TTPRB22-9126 (81349)	FT	REF				*	*	*	*			
M-H		WIRE, ELECTRICAL MILW16878TTPRB22-9 (81349)	FT	REF				*	*	*	*			
M-H		WIRE, ELECTRICAL 00702-1316 (70567)	FT	REF				*	*	*	*			
M-H		WIRE, ELECTRICAL 00702-1320 (70567)	FT	REF				*	*	*	*			
A-F		MODIFICATION KIT 549-5122-000 (13499)	EA	1										
P-O	5305-054-5635	SCREW, MACHINE MS51957-1 (96906)	EA	REF	*	*	*	*	*	*	*			
XI-O		PLATE, IDENTIFICATION 280-1254-000 (12998)	EA	REF										
		GROUP 06 - AUDIO CONTROL UNIT 159B-1												
A-O		AUDIO CONTROL UNIT 159B-1 522-0963-000 (13499)	EA	1								3-1	1A7	
A-F		COVER, GENERATOR 543-2857-005 (13499)	EA	REF										
XI-F		COVER, GENERATOR 543-2856-005 (13499)	EA	REF										
XI-F		CATCH, FLUSH H460D040-250 (83014)	EA	REF										
X2-F		RIVET, TUBULAR R400ECL-8CHROMATEDPL (12014)	EA	REF										
X2-F		COVER, AUDIO 543-2851-004 (13499)	EA	REF										
X2-F		COVER, REAR 543-2849-004 (13499)	EA	REF										
A-F		AMPLIFIER 522-0395-003 (13499)	EA	3								3-39	1A7A1	
A-F		AMPLIFIER 522-0395-003 (13499)	EA	REF								3-39	1A7A2	
A-F		AMPLIFIER 522-0395-003 (13499)	EA	REF								3-39	1A7A3	
M-H		INSULATION SLEEVING, ELECTRICAL MIL13190CLBALSIZ18-0 (81349)	FT	3										
M-H		INSULATION SLEEVING, ELECTRICAL TEFTW22-5 (81851)	FT	REF										
P-F	5910-542-7373	CAPACITOR, FIXED, ELECTROLYTIC 183-1127-000 (13499)	EA	2	*	*	*	*	*	*	*	3-41	1A7A1C102	
P-F	5910-542-7373	CAPACITOR, FIXED, ELECTROLYTIC 183-1127-000 (13499)	EA	REF	*	*	*	*	*	*	*	3-40	1A7A1C104	

SECTION III REPAIR PARTS FOR DIRECT SUPPORT, GENERAL SUPPORT, AND DEPOT MAINTENANCE (CONTINUED)

(1) SIR CODE	(2) FEDERAL STOCK NUMBER	(3) DESCRIPTION  REFERENCE NUMBER & MFR. CODE	(4) UNIT OF MEAS	(5) QTY INC IN UNIT	(6) 30-DAY DS MAINT ALLOWANCE			(7) 30-DAY GS MAINT ALLOWANCE			(8) YR ALM PER EQUIP CMTYCY	(9) DEPOT MAINT PER 100 EQUIP	(10) ILLUSTRATIONS	
					(a)	(b)	(c)	(a)	(b)	(c)			(a)	(b)
					1-20	21-50	51-100	1-20	21-50	51-100			FIG NO.	ITEM NO. OR REFERENCE DESIGNATION
XI-R		INSULATION SLEEVING, ELECTRICAL TEFTW22-6 (81851)	FT	REF										
M-R		INSULATION SLEEVING, ELECTRICAL TEFTW22-4 (81851)	FT	REF										
P-F		WASHER, FLAT 500-1099-003 (13499)	EA	8	*	*	*	*	*	*	*	*		
P-F	5310-042-9067	WASHER, LOCK MS33337-80 (96906)	EA	8	*	*	*	*	*	*	*	*		
P-F		NUT, PLAIN, HEXAGON P313-0132-000 (77250)	EA	REF	*	*	*	*	*	*	*	*		
P-F		NUT, PLAIN, HEXAGON P334-0257-000 (77250)	EA	3	*	*	*	*	*	*	*	*		
P-F	5340-200-7377	RING, RETAINING 542-7680-002 (13499)	EA	REF	*	*	*	*	*	*	*	*		
P-F	5305-770-2533	SCREW, MACHINE MS51959-13 (96906)	EA	REF	*	*	*	*	*	*	*	*		
P-F	5305-77-6039	SCREW, MACHINE MS51959-12 (96906)	EA	REF	*	*	*	*	*	*	*	*		
P-F	5305-054-5647	SCREW, MACHINE MS51959-13 (96906)	EA	REF	*	*	*	*	*	*	*	*		
P-F	5305-054-5648	SCREW, MACHINE MS51957-14 (96906)	EA	REF	*	*	*	*	*	*	*	*		
P-F	5961-542-7005	TRANSISTOR 2N158A (07688)	EA	1	*	*	*	*	*	*	*	*	3-40	1A7A1Q102
P-F	5961-800-1084	TRANSISTOR 2N44 (07688)	EA	1	*	*	*	*	*	*	*	*	3-40	1A7A1Q101
P-F	5905-660-3973	RESISTOR, VARIABLE, COMPOSITION RS19299 (71450)	EA	1	*	*	*	*	*	*	*	*	3-40	1A7A1R109
X2-F		HOLDER, RESISTOR 542-3815-002 (13499)	EA	3										
X2-F		SUPPORT 541-1499-002 (13499)	EA	3										
P-F		SCREW, SHOULDER 541-1500-002 (13499)	EA	8	*	*	*	*	*	*	*	*		
P-F	5305-687-6883	SCREW, TRANSISTOR 542-3814-002 (13499)	EA	3	*	*	*	*	*	*	*	*		
X2-F		COVER, AMPLIFIER 541-1490-001 (13499)	EA	3										
X2-F		RIVET, TUBULAR R4006X1-8CHROMATRIPL (12014)	EA	REF										
X2-F		COVER, AMPLIFIER 541-1508-003 (13499)	EA	3										
P-F		CLIP, SPRING 541-1501-002 (13499)	EA	3	*	*	*	*	*	*	*	*		
P-F		NUT, PLAIN, HEXAGON 541-1521-002 (13499)	EA	12	*	*	*	*	*	*	*	*		
X2-F		FRAME-STAKED 541-1491-001 (13499)	EA	3										
X2-F		FRAME, AMPLIFIER 541-1507-003 (13499)	EA	3										
P-R		FIN, LOCATING 540-7766-002 (13499)	EA	REF				*	*	*	*	*		
P-F	5420-678-5481	AMPLIFIER, SUBASSEMBLY 541-1505-002 (13499)	EA	1	*	*	*	*	*	*	*	*		1A7A1Z101

SECTION III REPAIR PARTS FOR DIRECT SUPPORT, GENERAL SUPPORT, AND DEPOT MAINTENANCE (CONTINUED)

(1) SIC CODE	(2) FEDERAL STOCK NUMBER	(3) DESCRIPTION  REFERENCE NUMBER & MFR. CODE	(4) UNIT OF MEAS	(5) QTY INC IN UNIT	(6) 30-DAY GS MAINT ALLOWANCE			(7) 30-DAY GS MAINT ALLOWANCE			(8) A RE ALM PER EQUIP CHRGY	(9) DEPOT ALM PER SDD EQUIP	(10) ILLUSTRATIONS FILE NO.	(11) ITEM NO. OR REFERENCE DESIGNATION
					(a) 1-30	(b) 21-30	(c) 31-100	(a) 1-20	(b) 21-50	(c) 51-100				
P-H	5910-714-3977	CAPACITOR, FIXED, ELECTROLYTIC 132D106C5025U0 (56289)	EA	1				*	*	*	*	3-40	1A7A1C101	
P-H	5910-069-0381	CAPACITOR, FIXED, ELECTROLYTIC 132D062901004 (56289)	EA	1				*	*	*	*	3-40	1A7A1C103	
M-H		WIRE, ELECTRICAL 00702-1320 (70567)	FT	REF										
M-H		INSULATOR, PLATE 541-9538-002 (13499)	EA	3										
P-F		SCREW, MACHINE P347-0006-000 (77250)	EA	15	*	*	*	*	*	*	*			
P-F		SCREW, MACHINE P347-0007-000 (77250)	EA	REF	*	*	*	*	*	*	*			
P-H	5950-679-9493	TRANSFORMER, AUDIO FREQUENCY 21603 (80089)	EA	1				*	*	*	*	3-40	1A7A1T102	
P-H	5950-683-3139	TRANSFORMER, AUDIO FREQUENCY BC3433 (97315)	EA	1				*	*	*	*	3-40	1A7A1T101	
P-H	5910-679-9491	CAPACITOR, FIXED, CERAMIC 913-3103-000 (00656)	EA	1				*	*	*	*	3-40	1A7A1C105	
P-H	5905-106-9344	RESISTOR, FIXED, COMPOSITION RC20GF101J (81349)	EA	1				*	*	*	*	3-40	1A7A1R108	
M-H		WASHER 542-7815-002 (13499)	EA	12										
P-H	5905-141-0595	RESISTOR, FIXED, COMPOSITION RC20GF472K (81349)	EA	2				*	*	*	*	3-40	1A7A1R103	
P-H	5905-141-0595	RESISTOR, FIXED, COMPOSITION RC20GF472K (81349)	EA	REF				*	*	*	*	3-40	1A7A1R105	
P-F	5905-245-0023	RESISTOR, FIXED, COMPOSITION RC20GF682K (81349)	EA	1	*	*	*	*	*	*	*	3-40	1A7A1R104	
P-H	5905-249-4248	RESISTOR, FIXED, COMPOSITION RC20GF333K (81349)	EA	1				*	*	*	*	3-40	1A7A1R102	
P-H	5905-171-1986	RESISTOR, FIXED, COMPOSITION RC20GF563J (81349)	EA	1				*	*	*	*	3-40	1A7A1R101	
P-H	5905-221-5860	RESISTOR, FIXED, COMPOSITION RC20GF334K (81349)	EA	1				*	*	*	*	3-40	1A7A1R110	
P-H	5905-552-3560	RESISTOR, FIXED, WIRE WOUND RSM2-150R0G (91637)	EA	1				*	*	*	*	3-40	1A7A1R106	
P-H	5935-816-9923	SOCKET, ELECTRON TUBE 220-1248-000 (13499)	EA	1				*	*	*	*	3-41	1A7ALXQ101	
P-F		NUT, PLAIN, HEXAGON P313-0132-000 (77250)	EA	REF	*	*	*	*	*	*	*			
P-H	5999-793-0192	TERMINAL BOARD 541-6523-002 (13499)	EA	1				*	*	*	*	3-41	1A7A1TB101	
P-H		TERMINAL, STUD 542-4094-002 (13499)	EA	REF				*	*	*	*			
XI-H		PRINTED CIRCUIT BOARD 541-1516-004 (13499)	EA	3										
XI-H		EYELET, METALLIC 542-0810-003 (13499)	EA	REF										
X2-H		EYELET, METALLIC 542-0811-003 (13499)	EA	REF										
P-F		WASHER 504-0729-003 (13499)	EA	3	*	*	*	*	*	*	*			
P-H	5310-857-5548	NUT, SELF-LOCKING, HEXAGON MS21044D04 (96906)	EA	REF				*	*	*	*			

SECTION III REPAIR PARTS FOR DIRECT SUPPORT, GENERAL SUPPORT, AND DEPOT MAINTENANCE (CONTINUED)

(1) SIR CODE	(2) FEDERAL STOCK NUMBER	(3) DESCRIPTION  USABLE ON CODE	(4) UNIT OF MEAS	(5) QTY INC IN UNIT	(6) 30-DAY DS MAINT ALLOWANCE			(7) 30-DAY GS MAINT ALLOWANCE			(8) 1 YR ALM PER EQUIP CATGY	(9) DEPOT MAINT ALM PER 100 EQUIP	(10) ILLUSTRATIONS	
					(a)	(b)	(c)	(a)	(b)	(c)			(a) FIG NO.	(b) ITEM NO. OR REFERENCE DESIGNATION
					1-20	21-50	51-100	1-20	21-50	51-100				
P-F	5820-703-2016	SPRING, TRANSISTOR 541-1504-002 (13499)	EA	3	*	*	*	*	*	*	*	*		
P-H	5330-812-5736	WASHER 541-1492-001 (13499)	EA	6				*	*	*	*	*		
P-H		WASHER, FLAT TMC302 (10583)	EA	6				*	*	*	*	*		
M-H		WIRE, ELECTRICAL 00702-1320 (70567)	FT	REF										
M-H		WIRE, ELECTRICAL MILW16878TYPE22-9 (81349)	FT	REF										
P-H		WIRE, ELECTRICAL MILW16878TYPE22-95 (81349)	FT	REF				*	*	*	*	*		
P-H	5310-958-7252	WASHER, LOCK AN936A416B (88044)	EA	12				*	*	*	*	*		
A-F		FRAME ASSEMBLY 540-6336-004 (13499)	EA	REF										
P-F		SETScrew 10-32X3-86SPLINE416SST (08664)	EA	REF	*	*	*	*	*	*	*	*		
P-F	5305-765-4346	SCREW, MACHINE MS51959-35 (96906)	EA	REF	*	*	*	*	*	*	*	*		
P-F	5305-765-4257	SCREW, MACHINE MS51959-43 (96906)	EA	REF	*	*	*	*	*	*	*	*		
P-F	5305-054-6650	SCREW, MACHINE MS51957-26 (96906)	EA	REF	*	*	*	*	*	*	*	*		
P-F	5305-579-3513	SCREW, MACHINE MS33217-55 (96906)	EA	REF	*	*	*	*	*	*	*	*		
P-F	5310-209-1360	WASHER, LOCK MS33335-98 (96906)	EA	REF	*	*	*	*	*	*	*	*		
P-F	5310-054-1831	WASHER, LOCK MS33338-81 (96906)	EA	REF	*	*	*	*	*	*	*	*		
P-F		POST, STANDOFF 561-2189-002 (13499)	EA	REF	*	*	*	*	*	*	*	*		
P-F	5315-791-7836	SCREW, EXTERNALLY RELIEVED BODY 540-6241-002 (13499)	EA	REF	*	*	*	*	*	*	*	*		
XI-F		BLOCK, SPACER 540-6243-002 (13499)	EA	REF										
X2-F		PLATE, HINGE 540-6240-002 (13499)	EA	REF										
X2-F		PLATE, PIVOT 540-6242-002 (13499)	EA	REF										
P-F	5340-634-7444	RING, RETAINING MS16632-1018 (96906)	EA	REF	*	*	*	*	*	*	*	*		
XI-F		BUMPER, CHASSIS 561-2375-003 (13499)	EA	REF										
X2-F		PLATE, HINGE 540-6260-002 (13499)	EA	REF										
XI-F		PIN, GROOVED 541-3627-002 (13499)	EA	REF										
X2-F		PLATE, HINGE 540-6236-002 (13499)	EA	REF										
X2-F		BLOCK, CENTER 540-6375-003 (13499)	EA	REF										
P-H		NUT, FLAIN, HEXAGON 540-6244-002 (13499)	EA	REF				*	*	*	*	*		

SECTION III REPAIR PARTS FOR DIRECT SUPPORT, GENERAL SUPPORT, AND DEPOT MAINTENANCE (CONTINUED)

(1) 300 CODE	(2) FEDERAL STOCK NUMBER	(3) DESCRIPTION  REFERENCE NUMBER & MFR. CODE	(4) UNITS OR MEAS.	(5) QTY REQD PER UNIT	(6) 30-DAY GS MAINT ALLOWANCE			(7) 30-DAY GS MAINT ALLOWANCE			(8) REPAIR PER EQUIP CATEGORY	(9) DEPOT MAINT PER 100 EQUIP	(10) ILLUSTRATIONS	
					(a) 1-20	(b) 21-50	(c) 51-100	(a) 1-20	(b) 21-50	(c) 51-100			(11) ITEM NO.	(12) OR REFERENCE DESIGNATION
X2-F		BLOCK, CENTER 540-6254-003 (13499)	EA	REF										
X2-F		FRAME-STAKED 540-6330-004 (13499)	EA	REF										
F-H		NUT, FLAIN, HEXAGON 540-6244-002 (13499)	EA	REF				*	*	*	*	*		
X2-F		FRAME-SPOTWELDED 540-6318-004 (13499)	EA	REF										
X1-F		CHANNEL, CHASSIS 540-6300-004 (13499)	EA	REF										
X1-F		CHANNEL, CHASSIS 540-6301-004 (13499)	EA	REF										
X1-F		BRACKET, END 540-6247-003 (13499)	EA	REF										
X2-F		PLATE, SPACER 540-6256-003 (13499)	EA	REF										
M-D		PLATE, IDENTIFICATION 546-7996-002 (13499)	EA	1										
M-D		PLATE, IDENTIFICATION 280-1254-000 (12998)	EA	REF										
A-O		AUDIO CONTROL UNIT SUBASSEMBLY 543-3046-000 (13499)	EA	1										
P-F	5950-679-9461	TRANSFORMER, AUDIO FREQUENCY A10760 (70674)	EA	2	*	*	*	*	*	*	*	*	3-42	1A7T2
P-F	5950-679-9461	TRANSFORMER, AUDIO FREQUENCY A10760 (70674)	EA	REF	*	*	*	*	*	*	*	*	3-42	1A7T3
P-F	5395-666-4508	CONNECTOR, RECEPTACLE, ELECTRICAL K6S (81312)	EA	4	*	*	*	*	*	*	*	*	3-42	1A7J1
P-F	5395-666-4508	CONNECTOR, RECEPTACLE, ELECTRICAL K6S (81312)	EA	REF	*	*	*	*	*	*	*	*	3-42	1A7J2
P-F	5395-666-4508	CONNECTOR, RECEPTACLE, ELECTRICAL K6S (81312)	EA	REF	*	*	*	*	*	*	*	*	3-42	1A7J3
P-F	5395-666-4508	CONNECTOR, RECEPTACLE, ELECTRICAL K6S (81312)	EA	REF	*	*	*	*	*	*	*	*	3-42	1A7J4
P-F		TERMINAL, STUD 2B10B12 (92825)	EA	3	*	*	*	*	*	*	*	*	3-42	1A7E1
P-F		TERMINAL, STUD 2B10B12 (92825)	EA	REF	*	*	*	*	*	*	*	*	3-42	1A7E2
P-F		TERMINAL, STUD 2B10B12 (92825)	EA	REF	*	*	*	*	*	*	*	*	3-42	1A7E3
P-F	5950-505-0259	TRANSFORMER, AUDIO FREQUENCY A9771 (70674)	EA	1	*	*	*	*	*	*	*	*	3-42	1A7T6
P-F	5950-679-9490	TRANSFORMER, AUDIO FREQUENCY 28130 (80089)	EA	1	*	*	*	*	*	*	*	*	3-42	1A7T7
P-F	5950-679-9488	TRANSFORMER, AUDIO FREQUENCY 25763 (73386)	EA	3	*	*	*	*	*	*	*	*	3-42	1A7T1
P-F	5950-679-9488	TRANSFORMER, AUDIO FREQUENCY 25763 (73386)	EA	REF	*	*	*	*	*	*	*	*	3-42	1A7T4
P-F	5950-679-9488	TRANSFORMER, AUDIO FREQUENCY 25763 (73386)	EA	REF	*	*	*	*	*	*	*	*	3-42	1A7T5
P-F	5910-542-7367	CAPACITOR, FIXED, ELECTROLYTIC D28454 (56289)	EA	1	*	*	*	*	*	*	*	*	3-43	1A7C22

TM11-5820-555-24P  
SECTION III REPAIR PARTS FOR DIRECT SUPPORT, GENERAL SUPPORT, AND DEPOT MAINTENANCE (CONTINUED)

(1) SIR CODE	(2) FEDERAL STOCK NUMBER	(3) DESCRIPTION  REFERENCE NUMBER & MFR. CODE	(4) UNIT OF MEAS  USABLE ON CODE	(5) QTY INC IN UNIT	(6) 30-DAY DS MAINT ALLOWANCE			(7) 30-DAY GS MAINT ALLOWANCE			(8) 1 YR ALW PER EQUIP CATGCT	(9) DEPOT MAINT ALW PER 100 EQUIP	(10) ILLUSTRATIONS	
					(a)	(b)	(c)	(a)	(b)	(c)			(a)	(b)
					1-20	21-50	51-100	1-20	21-50	51-100			FIG NO.	ITEM NO. OR REFERENCE DESIGNATION
P-F	5950-583-0976	REACTOR A10250 (70674)	EA	2	*	*	*	*	*	*	*	*	1A7L1	
P-F	5950-583-0976	REACTOR A10250 (70674)	EA	REF	*	*	*	*	*	*	*	*	3-42	1A7L2
P-F	5930-679-9487	SWITCH, ROTARY 185924F3 (76854)	EA	1	*	*	*	*	*	*	*	*	3-43	1A7S1
P-F	5905-818-0129	RESISTOR, VARIABLE, COMPOSITION KS22938 (71450)	EA	3	*	*	*	*	*	*	*	*	3-42	1A7R1
P-F	5905-818-0129	RESISTOR, VARIABLE, COMPOSITION KS22938 (71450)	EA	REF	*	*	*	*	*	*	*	*	3-42	1A7R2
P-F	5905-818-0129	RESISTOR, VARIABLE, COMPOSITION KS22938 (71450)	EA	REF	*	*	*	*	*	*	*	*	3-42	1A7R10
P-F	5905-679-9486	RESISTOR, VARIABLE, COMPOSITION JJJ68227 (01121)	EA	2	*	*	*	*	*	*	*	*	3-43	1A7R16
P-F	5905-679-9486	RESISTOR, VARIABLE, COMPOSITION JJJ68227 (01121)	EA	REF	*	*	*	*	*	*	*	*	3-43	1A7R21
XI-F		PANEL, POWER, DISTRIBUTOR 543-3048-003 (13499)	EA	1										
P-F	5935-283-1269	JACK, TELEPHONE J1034 (81349)	EA	1	*	*	*	*	*	*	*	*	3-42	1A7J6
P-F	5935-518-8696	CONNECTOR, RECEPTACLE, ELECTRICAL 80FG2F (02660)	EA	1	*	*	*	*	*	*	*	*	3-42	1A7J5
X2-F		PLATE, FRONT 543-3055-005 (13499)	EA	1										
X2-F		PLATE, FRONT 543-3054-005 (13499)	EA	1										
XI-F		POST, MOUNTING 543-1374-002 (13499)	EA	REF										
P-F		NUT, SELF-LOCKING, CLINCH F22NC2434-2-82 (72962)	EA	REF	*	*	*	*	*	*	*	*		
P-F	5935-853-7596	CONNECTOR, RECEPTACLE, ELECTRICAL UG1094U (80058)	EA	1	*	*	*	*	*	*	*	*	3-43	1A7J7
P-F		CONNECTOR, RECEPTACLE, ELECTRICAL MS35179-1094A (96906)	EA	1	*	*	*	*	*	*	*	*	3-43	1A7J7
M-H		INSULATION SLEEVING, ELECTRICAL 152-1743-000 (13499)	FT	REF										
P-F	5935-965-5571	ADAPTER, CABLE YE1620F32 (09922)	EA	REF	*	*	*	*	*	*	*	*		
P-H	5905-279-1756	RESISTOR, FIXED, COMPOSITION RC20GF151K (81349)	EA	8				*	*	*	*	*	3-42	1A7R3
P-H	5905-279-1756	RESISTOR, FIXED, COMPOSITION RC20GF151K (81349)	EA	REF				*	*	*	*	*	3-42	1A7R4
P-H	5905-279-1756	RESISTOR, FIXED, COMPOSITION RC20GF151K (81349)	EA	REF				*	*	*	*	*	3-42	1A7R5
P-H	5905-279-1756	RESISTOR, FIXED, COMPOSITION RC20GF151K (81349)	EA	REF				*	*	*	*	*	3-42	1A7R6
P-H	5905-279-1756	RESISTOR, FIXED, COMPOSITION RC20GF151K (81349)	EA	REF				*	*	*	*	*	3-43	1A7R11
P-H	5905-279-1756	RESISTOR, FIXED, COMPOSITION RC20GF151K (81349)	EA	REF				*	*	*	*	*	3-43	1A7R12
P-H	5905-279-1756	RESISTOR, FIXED, COMPOSITION RC20GF151K (81349)	EA	REF				*	*	*	*	*	3-42	1A7R14
P-H	5905-279-1756	RESISTOR, FIXED, COMPOSITION RC20GF151K (81349)	EA	REF				*	*	*	*	*	3-43	1A7R15
P-H	5905-106-1245	RESISTOR, FIXED, COMPOSITION RC32GF272K (81349)	EA	1				*	*	*	*	*	3-43	1A7R7

TM11-5820-555-24P  
SECTION III REPAIR PARTS FOR DIRECT SUPPORT, GENERAL SUPPORT, AND DEPOT MAINTENANCE (CONTINUED)

(1) SR CODE	(2) FEDERAL STOCK NUMBER	(3) DESCRIPTION  REFERENCE NUMBER & MFR. CODE	(4) UNIT OF MEAS	(5) QTY INC IN UNIT	(6) 30-DAY DS MAINT ALLOWANCE			(7) 30-DAY S. S. MAINT ALLOWANCE			(8) VEH ALN PER EQUIP CENCY	(9) DEPOT ALN PER 100 EQUIP	(10) ILLUSTRATIONS	
					(a) 1-20	(b) 21-50	(c) 51-100	(a) 1-20	(b) 21-50	(c) 51-100			(a) FIG NO.	(b) ITEM NO. OR REFERENCE DESIGNATION
P-F	5905-111-4742	RESISTOR, FIXED, COMPOSITION RC20GF991K (81349)	EA	2	*	*	*	*	*	*	*	*	3-43	1A788
P-F	5905-111-4742	RESISTOR, FIXED, COMPOSITION RC20GF991K (81349)	EA	REF	*	*	*	*	*	*	*	*	3-43	1A789
P-F	5905-951-8527	RESISTOR, FIXED, FILM RN65D3010F (81349)	EA	8	*	*	*	*	*	*	*	*	3-43	1A7817
P-F	5905-951-8527	RESISTOR, FIXED, FILM RN65D3010F (81349)	EA	REF	*	*	*	*	*	*	*	*	3-43	1A7818
P-F	5905-951-8527	RESISTOR, FIXED, FILM RN65D3010F (81349)	EA	REF	*	*	*	*	*	*	*	*	3-43	1A7819
P-F	5905-951-8527	RESISTOR, FIXED, FILM RN65D3010F (81349)	EA	REF	*	*	*	*	*	*	*	*	3-43	1A7820
P-F	5905-951-8527	RESISTOR, FIXED, FILM RN65D3010F (81349)	EA	REF	*	*	*	*	*	*	*	*	3-43	1A7822
P-F	5905-951-8527	RESISTOR, FIXED, FILM RN65D3010F (81349)	EA	REF	*	*	*	*	*	*	*	*	3-43	1A7823
P-F	5905-951-8527	RESISTOR, FIXED, FILM RN65D3010F (81349)	EA	REF	*	*	*	*	*	*	*	*	3-43	1A7824
P-F	5905-951-8527	RESISTOR, FIXED, FILM RN65D3010F (81349)	EA	REF	*	*	*	*	*	*	*	*	3-43	1A7825
M-H		WIRE, ELECTRICAL 00702-1322 (70567)	FT	REF										
M-H		WIRE, ELECTRICAL WTE22A (90484)	FT	REF										
M-H		INSULATION SLEEVING, ELECTRICAL TEPTW8B (81851)	FT	REF										
P-F	5325-276-4993	GROMMET, RUBBER 905 (75543)	EA	4	*	*	*	*	*	*	*	*		
XL-F		GROMMET, RUBBER MS35489-1 (96906)	EA	REF										
P-F	5310-934-9748	NUT, PLAIN, HEXAGON MS35649-44 (96906)	EA	REF	*	*	*	*	*	*	*	*		
M-H		INSULATION SLEEVING, ELECTRICAL MIL13190CLBALSIZ6-0 (81349)	FT	2										
P-F	5310-183-4354	WASHER, FLAT 506-7367-002 (13499)	EA	REF	*	*	*	*	*	*	*	*		
P-F	5365-205-4722	RING, RETAINING 5135-9C (79136)	EA	8	*	*	*	*	*	*	*	*		
P-F	5305-777-6039	SCREW, MACHINE MS51959-12 (96906)	EA	REF	*	*	*	*	*	*	*	*		
P-F		NUT, PLAIN, HEXAGON P313-0045-000 (77250)	EA	REF	*	*	*	*	*	*	*	*		
P-F	5310-011-1041	WASHER, LOCK MS35338-79 (96906)	EA	REF	*	*	*	*	*	*	*	*		
P-F	5310-209-1366	WASHER, LOCK MS35335-58 (96906)	EA	REF	*	*	*	*	*	*	*	*		
P-F	5305-054-5648	SCREW, MACHINE MS51957-14 (96906)	EA	REF	*	*	*	*	*	*	*	*		
P-H		TERMINAL, LUG MS51957-19 (96906)	EA	REF				*	*	*	*	*		
P-F		TERMINAL, LUG 2104-06-02-2520N (78189)	EA	REF	*	*	*	*	*	*	*	*		
P-F		WASHER, LOCK 1720-02CADPLATED (78189)	EA	REF	*	*	*	*	*	*	*	*		



SECTION III REPAIR PARTS FOR DIRECT SUPPORT, GENERAL SUPPORT, AND DEPOT MAINTENANCE (CONTINUED)

(1) SIR CODE	(2) FEDERAL STOCK NUMBER	(3) DESCRIPTION  REFERENCE NUMBER & MFR. CODE	(4) UNIT OF MEAS	(5) QTY INC IN UNIT	(6) 30-DAY GS MAINT ALLOWANCE			(7) 30-DAY GS MAINT ALLOWANCE			(8) 1 YR ALW PER EQUIP CNTGTY	(9) DEPOT MAINT ALW PER 100 EQUIP	(10) ILLUSTRATIONS	
					(a) 1-20	(b) 21-50	(c) 51-100	(a) 1-20	(b) 21-50	(c) 51-100			(a) FIG NO.	(b) ITEM NO. OR REFERENCE DESIGNATION
P-F		NUT, FLAIN, HEXAGON P334-4120-000 (77250)	EA	REF	*	*	*	*	*	*	*			
P-F		INSULATION SLEEVING, ELECTRICAL TEFTW22B (81851)	FT	REF	*	*	*	*	*	*	*			
M-H		INSULATION SLEEVING, ELECTRICAL 1151HAI-24-0 (81851)	FT	1										
P-F		BUSHING AND NUT UB241HIFL (37942)	EA	7	*	*	*	*	*	*	*			
M-H		INSULATION SLEEVING, ELECTRICAL FLEXITEFLONGB (03890)	FT	REF										
P-F	5355-079-9556	KNOB, MODIFIED 547-1380-002 (13499)	EA	REF	*	*	*	*	*	*	*			
XI-F		KNOB 1400XBLK (72512)	EA	1									1A701	
P-F		NUT, FLAIN, HEXAGON 334-4121-000 (13499)	EA	1	*	*	*	*	*	*	*			
P-F	5940-500-74227	TERMINAL, LUG 31-759 (02660)	EA	REF	*	*	*	*	*	*	*			
P-F	5355-156-6559	SHAFT LOCK, ELECTRONIC COMPONENT 10061 (76487)	EA	4	*	*	*	*	*	*	*			
XI-F		POST, SPACING, PANEL 541-0164-002 (13499)	EA	4										
P-F		SCREW, MACHINE P342-0024-000 (77250)	EA	REF	*	*	*	*	*	*	*			
P-F	5305-054-6653	SCREW, MACHINE MS51957-29 (96906)	EA	REF	*	*	*	*	*	*	*			
M-H		INSULATION SLEEVING, ELECTRICAL TEFTW20B (81851)	EA	REF										
P-F	5310-058-3599	WASHER, LOCK MS3535-57 (96906)	EA	REF	*	*	*	*	*	*	*			
M-H		INSULATION SLEEVING, ELECTRICAL 4-48XL-86SPLINEOVPT18-BSST (08664)	FT	REF										
M-H		INSULATION SLEEVING, ELECTRICAL TEFTW10B (81851)	FT	REF										
P-F	5305-763-7822	SCREW, MACHINE MS51959-14 (96906)	EA	REF	*	*	*	*	*	*	*			
P-F	5305-054-6651	SCREW, MACHINE MS51957-27 (96906)	EA	REF	*	*	*	*	*	*	*			
P-F		SETScrew 335-0041-000 (08664)	EA	REF	*	*	*	*	*	*	*			
M-H		CABLE ASSEMBLY, SPECIAL PURPOSE 543-3045-000 (13499)	EA	1										
M-H		WIRE, ELECTRICAL MILW16878TYPE22-9 (81349)	FT	REF										
M-H		WIRE, ELECTRICAL MILW16878TYPE22-90 (81349)	FT	REF										
M-H		WIRE, ELECTRICAL MILW16878TYPE22-91 (81349)	FT	REF										
M-H		WIRE, ELECTRICAL MILW16878TYPE22-92 (81349)	FT	REF										
M-H		WIRE, ELECTRICAL MILW16878TYPE22-93 (81349)	FT	REF										
M-H		WIRE, ELECTRICAL MILW16878TYPE22-95 (81349)	FT	REF										

SECTION III REPAIR PARTS FOR DIRECT SUPPORT, GENERAL SUPPORT, AND DEPOT MAINTENANCE (CONTINUED)

(1) SR CODE	(2) FEDERAL STOCK NUMBER	(3) DESCRIPTION  REFERENCE NUMBER & MFR. CODE	(4) UNIT OF MEAS	(5) QTY REQ IN UNIT	(6) 30-DAY DS MAINT ALLOWANCE			(7) 30-DAY ES MAINT ALLOWANCE			(8) VE ALM PER EQUIP ENTRNY	(9) DEPOT ALM PER ADD EQUIP	(10) ILLUSTRATIONS	
					(a) 1-20	(b) 21-50	(c) 51-100	(a) 1-20	(b) 21-50	(c) 51-100			(11) FIG NO.	(12) ITEM NO. OR REFERENCE DESIGNATION
M-H		WIRE, ELECTRICAL MILW16878TYPER22-96 (81349)	FT	REF										
M-H		WIRE, ELECTRICAL MILW16878TYPER22-902 (81349)	FT	REF										
M-H		WIRE, ELECTRICAL MILW16878TYPER22-903 (81349)	FT	REF										
M-H		WIRE, ELECTRICAL MILW16878TYPER22-905 (81349)	FT	REF										
M-H		WIRE, ELECTRICAL MILW16878TYPER22-906 (81349)	FT	REF										
M-H		WIRE, ELECTRICAL MILW16878TYPER22-912 (81349)	FT	REF										
M-H		WIRE, ELECTRICAL MILW16878TYPER22-913 (81349)	FT	REF										
M-H		WIRE, ELECTRICAL MILW16878TYPER22-935 (81349)	FT	REF										
M-H		CABLE, SPECIAL PURPOSE, ELECTRICAL LSBUB730W9 (90484)	FT	1										
M-H		CABLE, SPECIAL PURPOSE, ELECTRICAL LSBUB730W90 (90484)	FT	REF										
M-H		CABLE, SPECIAL PURPOSE, ELECTRICAL LSBUB730W91 (90484)	FT	REF										
M-H		CABLE, SPECIAL PURPOSE, ELECTRICAL LSBUB730W92 (90484)	FT	REF										
M-H		CABLE, SPECIAL PURPOSE, ELECTRICAL LSBUB730W93 (90484)	FT	REF										
M-H		CABLE, SPECIAL PURPOSE, ELECTRICAL LSBUB730W95 (90484)	FT	REF										
M-H		CABLE, SPECIAL PURPOSE, ELECTRICAL LSBUB730W96 (90484)	FT	3										
M-H		CABLE, SPECIAL PURPOSE, ELECTRICAL LSBUB730W92 (90484)	FT	1										
P-H		CABLE, SPECIAL PURPOSE, ELECTRICAL 2SBUB730WJA109-6 (90484)	FT	REF				*	*	*	*	*		
P-H		CABLE, SPECIAL PURPOSE, ELECTRICAL 2SBUB730WJA109-1 (90484)	FT	REF				*	*	*	*	*		
M-H		CABLE, SPECIAL PURPOSE, ELECTRICAL LSBUB730WJA10-1 (90484)	FT	1										
M-H		CABLE, SPECIAL PURPOSE, ELECTRICAL LSBUB730WJA10-3 (90484)	FT	1										
M-H		CABLE, SPECIAL PURPOSE, ELECTRICAL LSBUB730WJA10-5 (90484)	FT	1										
M-H		CABLE, SPECIAL PURPOSE, ELECTRICAL LSBUB730WJA10-6 (90484)	FT	2										
P-F	5940-204-7132	FERRULE, RADIO FREQUENCY, GROUNDING GSB058 (59730)	EA	12	*	*	*	*	*	*	*	*		
P-F	5940-280-3829	FERRULE, RADIO FREQUENCY, GROUNDING GSC128 (59730)	EA	REF	*	*	*	*	*	*	*	*		
M-H		INSULATION SLEEVING, ELECTRICAL RNF100 3-16BLK (08795)	FT	1										
M-H		INSULATION SLEEVING, ELECTRICAL RNF100 1-8BLK (08795)	FT	1										
M-H		WIRE, ELECTRICAL BUB734W91 (90484)	FT	REF										

SECTION III REPAIR PARTS FOR DIRECT SUPPORT, GENERAL SUPPORT, AND DEPOT MAINTENANCE (CONTINUED)

(1) SR CODE	(2) FEDERAL STOCK NUMBER	(3) DESCRIPTION  USABLE ON CODE	(4) UNIT OF MEAS	(5) QTY INC IN UNIT	(6) 30-DAY DS MAINT ALLOWANCE			(7) 30-DAY GS MAINT ALLOWANCE			(8) 1 YR ALW PER EQUIP CNTGTY	(9) DEPOT MAINT ALW PER 100 EQUIP	(10) ILLUSTRATIONS	
					(a)	(b)	(c)	(a)	(b)	(c)			(a)	(b)
					1-20	21-60	61-100	1-20	21-60	61-100			FIG NO.	ITEM NO. OR REFERENCE DESIGNATION
M-R		WIRE, ELECTRICAL MILW16878B22-926 (81349)	FT	REF										
M-R		CLAMP, LOOP HP3N (09922)	EA	REF										
M-R		CLAMP, LOOP HP7N (09922)	EA	REF										
P-F	5310-275-1347	WASHER, FLAT 310-0046-000 (79807)	EA	REF	*	*	*	*	*	*	*	*		
P-F		NUT, PLAIN, HEXAGON MS35699-64 (96906)	EA	REF	*	*	*	*	*	*	*	*		
P-F	5305-054-6652	SCREW, MACHINE MS51957-28 (96906)	EA	REF	*	*	*	*	*	*	*	*		
P-F	5355-668-5311	KNOB 1450WBK (72512)	EA	1	*	*	*	*	*	*	*	*		1A702
A-F		CASE, SHIELDING 543-6266-002 (13499)	EA	2										
X2-F		CASE, SHIELD-RADIO FREQUENCY 543-6265-002 (13499)	EA	2										
XI-F		BOLT, EYE A24P6-861 (79251)	EA	4										
XI-F		RIVET, TUBULAR R3802X1-8 (12014)	EA	4										
P-F	5910-556-1425	CAPACITOR, FIXED, CERAMIC DIELECTRIC 33C2 (01939)	EA	1	*	*	*	*	*	*	*	*	3-43	1A7023
P-F	5945-679-9554	RELAY, ARMATURE 11F-93590 (78277)	EA	1	*	*	*	*	*	*	*	*	3-43	1A7K1
P-F	5905-279-1869	RESISTOR, FIXED, COMPOSITION RC20GF121K (81349)	EA	1	*	*	*	*	*	*	*	*	3-43	1A7B27
P-H	5905-195-6800	RESISTOR, FIXED, COMPOSITION RC20GF361K (81349)	EA	1	*	*	*	*	*	*	*	*	3-43	1A7B26
P-F	5905-473-5251	RESISTOR, FIXED, COMPOSITION RC320F102K (81349)	EA	1	*	*	*	*	*	*	*	*	3-43	1A7B28
P-F	5305-054-5647	SCREW, MACHINE MS51957-13 (96906)	EA	REF	*	*	*	*	*	*	*	*		
P-F	5935-204-7705	CONNECTOR, RECEPTACLE, ELECTRICAL 26-4401-16S (02660)	EA	1	*	*	*	*	*	*	*	*	3-43	1A7J8
P-F	5935-296-8720	CONNECTOR, RECEPTACLE, ELECTRICAL 26-4403-16S (02660)	EA	1	*	*	*	*	*	*	*	*	3-43	1A7J9
A-F		PLATE, RETAINING 544-2891-003 (13499)	EA	1										
P-F		NUT, CAPTIVE NCN6-2-2-1 (07886)	EA	REF	*	*	*	*	*	*	*	*		
X2-F		PLATE, RETAINING 544-2890-003 (13499)	EA	1										
A-O		AMPLIFIER 522-0388-003 (13499)	EA	1									3-39	1A7A4
P-F		WASHER-COPPER 542-1587-003 (13499)	EA	2	*	*	*	*	*	*	*	*		
P-O	5920-280-4465	FUSE, CARTRIDGE FO2A250VLAS (81349)	EA	1	*	*	*	*	*	*	*	*	3-44	1A7A4F20
P-F		WASHER-TEFLON 542-1579-003 (13499)	EA	1	*	*	*	*	*	*	*	*		
P-F		WASHER-MICA 541-1243-003 (13499)	EA	2	*	*	*	*	*	*	*	*		

TM11-5820-555-24P  
SECTION III REPAIR PARTS FOR DIRECT SUPPORT, GENERAL SUPPORT, AND DEPOT MAINTENANCE (CONTINUED)

(1) SR CODE	(2) FEDERAL STOCK NUMBER	(3) DESCRIPTION  REFERENCE NUMBER & MFR. CODE	(4) UNIT OF MEAS	(5) QTY REQ'D UNIT	(6) 30-DAY DS MAINT ALLOWANCE			(7) 30-DAY GS MAINT ALLOWANCE			(8) 1 YR ALM PER EQUIP CENCY	(9) DEPOT MAINT ALM PER 100 EQUIP	(10) ILLUSTRATIONS	
					(a) 1-20	(b) 21-50	(c) 51-100	(a) 1-20	(b) 21-50	(c) 51-100			(a) FIG NO.	(b) ITEM NO. OR REFERENCE DESIGNATION
P-F	5310-042-9067	WASHER, LOCK MS3537-80 (96906)	EA	REF	*	*	*	*	*	*	*			
P-F		NUT, FLAIN, HEXAGON P313-0132-000 (77250)	EA	REF	*	*	*	*	*	*	*			
P-F	5340-200-7377	RING, RETAINING ME16633-1015 (96906)	EA	REF	*	*	*	*	*	*	*			
P-F	5305-054-5646	SCREW, MACHINE MS51957-12 (96906)	EA	REF	*	*	*	*	*	*	*			
P-F	5961-542-7005	TRANSISTOR 2N158A (07688)	EA	2	*	*	*	*	*	*	*	3-45	1A7A4Q201	
P-F	5961-542-7005	TRANSISTOR 2N158A (07688)	EA	REF	*	*	*	*	*	*	*	3-45	1A7A4Q202	
P-F		WASHER, FLAT 500-1099-003 (13499)	EA	REF	*	*	*	*	*	*	*			
P-F	5305-705-9528	SCREW, EXTERNALLY RELIEVED BODY 542-1348-002 (13499)	EA	2	*	*	*	*	*	*	*			
P-F		SCREW, SHOULDER 541-1500-002 (13499)	EA	REF	*	*	*	*	*	*	*			
X2-F		FRAME, STAKED 541-6536-001 (13499)	EA	1										
P-H		PIN, LOCATING 540-7766-002 (13499)	EA	REF				*	*	*	*			
X2-F		FRAME, AMPLIFIER 541-6546-004 (13499)	EA	1										
X2-F		FRAME, WELDED 541-6545-004 (13499)	EA	1										
A-F		AMPLIFIER, SUBASSEMBLY 541-6541-002 (13499)	EA	1									1A7A4Z201	
P-F	5950-679-9494	TRANSFORMER, AUDIO FREQUENCY 27803 (73386)	EA	1	*	*	*	*	*	*	*	3-45	1A7A4T201	
P-H		RETAINER, CAPACITOR E50005-051 (80033)	EA	1				*	*	*	*			
P-F	5910-542-7373	CAPACITOR, FIXED, ELECTROLYTIC 183-1127-000 (13499)	EA	1	*	*	*	*	*	*	*	3-45	1A7A4C201	
P-F		NUT, FLAIN, HEXAGON P313-0132-000 (77250)	EA	REF	*	*	*	*	*	*	*			
P-F		SCREW, MACHINE P347-0006-000 (77250)	EA	REF	*	*	*	*	*	*	*			
P-H	5999-793-0193	TERMINAL BOARD 541-6540-002 (13499)	EA	1				*	*	*	*			
X1-F		CLIP, ELECTRICAL-FUSE, SHORT 541-6563-002 (13499)	EA	2										
P-H	5920-929-1999	CLIP, ELECTRICAL 122044 (75915)	EA	1				*	*	*	*		1A7A4E201	
X1-I		RIVET, TUBULAR R3472X2-16CADPL (12014)	EA	2										
P-H		TERMINAL, STUD 542-4094-002 (13499)	EA	REF				*	*	*	*			
X1-I		PRINTED CIRCUIT BOARD 541-6544-004 (13499)	EA	1										
X1-I		EYELET, METALLIC 542-0810-003 (13499)	EA	REF										

SECTION III REPAIR PARTS FOR DIRECT SUPPORT, GENERAL SUPPORT, AND DEPOT MAINTENANCE (CONTINUED)

(1) SIR CODE	(2) FEDERAL STOCK NUMBER	(3) DESCRIPTION  REFERENCE NUMBER & MFR. CODE	(4) UNIT OF MEAS	(5) QTY INC IN UNIT	(6) 30-DAY DS MAINT ALLOWANCE			(7) 30-DAY GS MAINT ALLOWANCE			(8) 1 YR ALW PER EQUIP CNTYCY	(9) DEPOT MAINT ALW PER 100 EQUIP	(10) ILLUSTRATIONS	
					(a) 1-20	(b) 21-50	(c) 51-100	(a) 1-20	(b) 21-50	(c) 51-100			(a) FIG NO.	(b) ITEM NO. OR REFERENCE DESIGNATION
P-F	5905-901-6490	RESISTOR, FIXED, WIRE WOUND R1342-1-78-1PCT (15909)	EA	2	*	*	*	*	*	*	*	*	3-45	1A7A4R201
P-F	5905-901-6490	RESISTOR, FIXED, WIRE WOUND R1342-1-78-1PCT (15909)	EA	REF	*	*	*	*	*	*	*	*	3-45	1A7A4R202
P-F	5905-171-2009	RESISTOR, FIXED, COMPOSITION RC200F222K (61349)	EA	2	*	*	*	*	*	*	*	*	3-45	1A7A4R203
P-F	5905-171-2009	RESISTOR, FIXED, COMPOSITION RC200F222K (61349)	EA	REF	*	*	*	*	*	*	*	*	3-45	1A7A4R204
P-F	5905-542-7643	RESISTOR, VARIABLE JA21C69 (71450)	EA	1	*	*	*	*	*	*	*	*	3-45	1A7A4R205
P-F	5310-907-0958	WASHER, FLAT 310-0045-000 (79807)	EA	REF	*	*	*	*	*	*	*	*		
P-F	5310-934-9748	NUT, FLAIN, HEXAGON MS39649-44 (96906)	EA	REF	*	*	*	*	*	*	*	*		
P-F	5305-034-6631	SCREW, MACHINE MS51957-27 (96906)	EA	REF	*	*	*	*	*	*	*	*		
P-F	5305-054-6653	SCREW, MACHINE MS51957-29 (96906)	EA	REF	*	*	*	*	*	*	*	*		
P-F	5310-011-1041	WASHER, LOCK MS39338-79 (96906)	EA	REF	*	*	*	*	*	*	*	*		
P-F		WASHER, FLAT 310-6360-000 (79807)	EA	REF	*	*	*	*	*	*	*	*		
P-O		SCREW, TAPPING, THREAD 2XL-8FANEDTTYPECADFL (45722)	EA	REF	*	*	*	*	*	*	*	*		
P-O	5305-054-5635	SCREW, MACHINE MS51957-1 (96906)	EA	REF	*	*	*	*	*	*	*	*		
P-F	5310-058-3829	WASHER, LOCK MS39338-77 (96906)	EA	REF	*	*	*	*	*	*	*	*		
P-O		KIT, MOUNTING 941-1477-002 (13499)	EA	REF	*	*	*	*	*	*	*	*		
M-H		BAG, COTTON 024-0100-000 (13499)	EA	REF	*	*	*	*	*	*	*	*		
P-O	5310-054-1830	WASHER, LOCK MS39338-80 (96906)	EA	REF	*	*	*	*	*	*	*	*		
P-O		WASHER, FLAT 310-0167-000 (79807)	EA	REF	*	*	*	*	*	*	*	*		
P-O		WASHER, LOCK 310-0286-000 (13499)	EA	REF	*	*	*	*	*	*	*	*		
P-O	5305-579-3507	SCREW, MACHINE 310-0286-000 (13499)	EA	REF	*	*	*	*	*	*	*	*		
P-O		SCREW, MACHINE P343-0247-000 (77230)	EA	REF	*	*	*	*	*	*	*	*		
X2-O		PLATE, IDENTIFICATION 280-0430-000 (74048)	EA	REF	*	*	*	*	*	*	*	*		
X1-O		PLATE, SLIDING MS21044D06 (96906)	EA	REF	*	*	*	*	*	*	*	*		
P-F	5310-857-5547	NUT, SELF-LOCKING, HEXAGON MS21044D06 (96906)	EA	REF	*	*	*	*	*	*	*	*		

TM11-5820-555-24P  
SECTION III REPAIR PARTS FOR DIRECT SUPPORT, GENERAL SUPPORT, AND DEPOT MAINTENANCE (CONTINUED)

(1) SQ CODE	(2) FEDERAL STOCK NUMBER	(3) DESCRIPTION  REFERENCE NUMBER & MFR. CODE	(4) UNIT OF MEAS	(5) QTY INC IN UNIT	(6) 30-DAY DS MAINT ALLOWANCE			(7) 30-DAY GS MAINT ALLOWANCE			(8) 1 YR ALW PER EQUIP CATGORY	(9) DEPOT MAINT ALW PER 100 EQUIP	(10) ILLUSTRATIONS	
					(a) 1-20	(b) 21-50	(c) 51-100	(a) 1-20	(b) 21-50	(c) 51-100			(a) FIG NO.	(b) ITEM NO. OR REFERENCE DESIGNATION
		GROUP 07 - COOLER, AIR, ELECTRICAL EQUIPMENT HD-347/U												
A-O-R		COOLER, AIR, ELECTRICAL EQUIPMENT HD-347/U 522-0983-005 (13499)	EA	1								3-1	1A11	
P-F	4730-816-2787	CLAMP, HOSE A6 (05657)	EA	4	*	*	*	*	*	*	*			
M-H		FILTER, AIR 554-4883-003 (13499)	EA	1										
P-H	4140-856-0533	FAN, CENTRIFUGAL A013354 (82877)	EA	1			*	*	*	*	*	3-46	1A11B1	
P-H	5340-658-8246	MOUNT, RESILIENT 106PLW2 (76005)	EA	2			*	*	*	*	*			
P-H	5340-793-3649	MOUNT, RESILIENT 106PLW3 (76005)	EA	2			*	*	*	*	*			
P-H	5930-679-9507	SWITCH, PRESSURE 3260430100 (01146)	EA	1			*	*	*	*	*	3-46	1A11S1	
P-O		KIT, FUSE 543-3409-000 (13499)	EA	1	*	*	*	*	*	*	*	3-46	1A11F1	
M-O		ENVELOPE, PACKAGING 025-0001-000 (13499)	EA	REF										
P-O	5920-855-4260	FUSE, CARTRIDGE F02B125V2AS (81349)	EA	1	*	*	*	*	*	*	*			
P-O	5920-850-6091	FUSE, CARTRIDGE F02B250V1AS (81349)	EA	1	*	*	*	*	*	*	*			
P-F	5920-655-4133	FUSEHOLDER HKL1FWZZ (71400)	EA	1	*	*	*	*	*	*	*	3-46	1A11XF1	
M-D		PLATE, IDENTIFICATION 280-1254-000 (12998)	EA	REF										
P-F	5310-054-1830	WASHER, LOCK MS35338-80 (96906)	EA	REF	*	*	*	*	*	*	*			
P-F	5310-058-2951	WASHER, LOCK MS35337-81 (96906)	EA	4	*	*	*	*	*	*	*			
P-F	5310-042-9609	WASHER, LOCK MS35338-78 (96906)	EA	REF	*	*	*	*	*	*	*			
P-F	5310-011-1041	WASHER, LOCK MS35338-79 (96906)	EA	REF	*	*	*	*	*	*	*			
P-F		NUT, PLAIN, HEXAGON MS35699-64 (96906)	EA	REF	*	*	*	*	*	*	*			
P-F	5310-271-4645	NUT, PLAIN, HEXAGON MS35649-84 (96906)	EA	REF	*	*	*	*	*	*	*			
P-F	5310-934-4748	NUT, PLAIN, HEXAGON MS35649-44 (96906)	EA	REF	*	*	*	*	*	*	*			
P-F		NUT, PLAIN, HEXAGON 334-0010-000 (13499)	EA	1	*	*	*	*	*	*	*			
P-F	5305-054-6651	SCREW, MACHINE MS1957-27 (96906)	EA	REF	*	*	*	*	*	*	*			
P-F	5305-763-6963	SCREW, MACHINE MS1959-28 (96906)	EA	REF	*	*	*	*	*	*	*			
P-F	5305-727-8832	SCREW, MACHINE MS1959-29 (96906)	EA	REF	*	*	*	*	*	*	*			
P-F	5305-579-3507	SCREW, MACHINE MS3216-40 (96906)	EA	REF	*	*	*	*	*	*	*			

SECTION III REPAIR PARTS FOR DIRECT SUPPORT, GENERAL SUPPORT, AND DEPOT MAINTENANCE (CONTINUED)

(1) SR CODE	(2) FEDERAL STOCK NUMBER	(3) DESCRIPTION  REFERENCE NUMBER & MFR. CODE	(4) UNIT OF MEAS	(5) QTY REQ. IN UNIT	(6) 30-DAY DS MAINT ALLOWANCE			(7) 30-DAY GS MAINT ALLOWANCE			(8) 1 YR ALW PER EQUIP CATG/CY	(9) DEPOT MAINT ALW PER 100 EQUIP	(10) ILLUSTRATIONS	
					(a) 1-20	(b) 21-50	(c) 51-100	(a) 1-20	(b) 21-50	(c) 51-100			(a) FIG NO.	(b) ITEM NO. OR REFERENCE DESIGNATION
P-F	5305-054-5648	SCREW, MACHINE MS51957-14 (96906)	EA	REF	*	*	*	*	*	*	*			
P-F		SCREW, TAPPING, THREAD 2XL-8FAMEDTTPSCADPL (45722)	EA	REF	*	*	*	*	*	*	*			
P-F	5305-039-8591	SCREW, MACHINE MS35217-53 (96906)	EA	REF	*	*	*	*	*	*	*			
P-F		SCREW, MACHINE P343-0284-000 (77250)	EA	REF	*	*	*	*	*	*	*			
P-F	5305-054-6652	SCREW, MACHINE MS51957-28 (96906)	EA	REF	*	*	*	*	*	*	*			
P-F		SCREW, MACHINE P343-0194-000 (77250)	EA	4	*	*	*	*	*	*	*			
P-F		WASHER, LOCK 1724-02CADPL (78189)	EA	REF	*	*	*	*	*	*	*			
E2-F		HOUSING ASSEMBLY 543-3419-005 (13499)	EA	1										
E2-F		HOUSING, BLOWER 543-3418-005 (13499)	EA	1										
P-H	5325-505-4798	RECEPTACLE, TURBLOK 212-12 (71286)	EA	6				*	*	*	*			
P-H	5320-117-6938	RIVET, SOLID MS20426AD3-4 (96906)	EA	REF				*	*	*	*			
X1-H		NUT, BLIND, RIVET A25-200 (25472)	EA	1										
E2-H		BRACKET 542-0885-003 (13499)	EA	1										
E2-H		BRACKET 543-3420-004 (13499)	EA	1										
P-H		RETAINER, CAPACITOR 542-0878-002 (13499)	EA	1				*	*	*	*			
E2-H		BRACKET, MOUNTING 542-0879-002 (13499)	EA	1										
E2-H		BRACKET, RETAINING 542-0880-002 (13499)	EA	1										
E2-H		BRACKET, AIR 542-0886-003 (13499)	EA	1										
M-H		DUCT, CANVAS 542-0887-003 (13499)	EA	1										
E2-H		COVER, FILTER 542-0890-004 (13499)	EA	1										
E2-H		COVER 542-0889-004 (13499)	EA	1										
P-H	5325-282-0624	STUD, ASSEMBLY, TURBLOK 2600-3 (71286)	EA	2				*	*	*	*			
P-H	5310-337-8329	PUSH ON NUT 2600LN (71286)	EA	8				*	*	*	*			
M-D		PLATE, INSTRUCTIONS 280-1866-000 (13499)	EA	1										
X1-F		RIVET, TUBULAR B3484X1-SCADPL (12014)	EA	REF										
A-F		FRAME, FRONT 542-0892-004 (13499)	EA	1										
X1-F		COVER, FRONT 542-0891-004 (13499)	EA	1										

TM11-5820-555-24P  
SECTION III REPAIR PARTS FOR DIRECT SUPPORT, GENERAL SUPPORT, AND DEPOT MAINTENANCE (CONTINUED)

(1) S&R CODE	(2) FEDERAL STOCK NUMBER	(3) DESCRIPTION  REFERENCE NUMBER & MFR. CODE	(4) UNIT OF MEAS	(5) QTY REQ IN UNIT	(6) 30-DAY DS MAINT ALLOWANCE			(7) 30-DAY GS MAINT ALLOWANCE			(8) 1 YR ALN PER EQUIP CITUCY	(9) DEPOT MAINT ALN PER 900 EQUIP	(10) ILLUSTRATIONS	
					(a) 1-50	(b) 51-100	(c) 101-150	(a) 1-50	(b) 51-100	(c) 101-150			(a) FIG NO.	(b) ITEM NO. OR REFERENCE DESIGNATION
P-H	5320-117-6938	RIVET, SOLID MS20426AD3-4 (96906)	EA	REF				*	*	*	*	*		
P-F	5325-298-7109	STUD, ASSEMBLY, TURNLOCK 2600-5 (71286)	EA	4	*	*	*	*	*	*	*	*		
P-H	5310-337-8329	PUSH ON NUT 2600LN (71286)	EA	REF				*	*	*	*	*		
P-F	5325-543-3670	RECEPTACLE, TURNLOCK 26R1-1 (71286)	EA	2	*	*	*	*	*	*	*	*		
M-H		HOSE, RUBBER 542-0881-002 (13499)	EA	2										
M-H		TUBE, RUBBER 200-1203-000 (13499)	FT	2										
A-H		CABLE ASSEMBLY, SPECIAL PURPOSE 543-3433-000 (13499)	EA	1										
M-H		INSULATION SLEEVING, ELECTRICAL MIL13190CLBA1SIZE12-0 (81349)	FT	1										
M-H		WIRE, ELECTRICAL BUC726M9 (90484)	FT	2										
M-H		WIRE, ELECTRICAL BUC726M90 (90484)	FT	REF										
M-H		WIRE, ELECTRICAL BUC726M91 (90484)	FT	REF										
M-H		WIRE, ELECTRICAL BUC726M92 (90484)	FT	1										
M-H		WIRE, ELECTRICAL BUC726M93 (90484)	FT	1										
M-H		WIRE, ELECTRICAL BUC726M902 (90484)	FT	2										
M-H		WIRE, ELECTRICAL BUC726M906 (90484)	FT	4										
P-H	5940-331-2892	TERMINAL, LUG 31902 (00779)	EA	REF				*	*	*	*	*		
M-H		TERMINAL, LUG MS25036-2 (96906)	EA	REF										
P-H	5940-246-3853	TERMINAL, LUG 32442 (00779)	EA	REF				*	*	*	*	*		
M-H		INSULATION SLEEVING, ELECTRICAL MIL13190CLBA1SIZE4-0 (81349)	FT	3										
P-F	5935-204-5833	CONNECTOR, RECEPTACLE 26-4401-8S (02660)	EA	1	*	*	*	*	*	*	*	*	3-46	1A11J1
P-F	5910-668-7223	CAPACITOR, FIXED, PAPER DIELECTRIC P50922 (56289)	EA	1	*	*	*	*	*	*	*	*	3-46	1A11C1
X2-I		BRACKET 542-0884-002 (13499)	EA	4										
X2-I		BRACKET 542-0883-002 (13499)	EA	4										
X1-I		NUT, SELF-LOCKING, CLINCH F22NC2-62 (72962)	EA	16										
P-F	5325-281-1557	GROMMET, RUBBER MS35489-17 (96906)	EA	1	*	*	*	*	*	*	*	*		
M-H		TERMINAL BOARD 353-11-06-001 (71785)	EA	1										
P-F	5325-174-5317	GROMMET, RUBBER MS35489-4 (96906)	EA	REF	*	*	*	*	*	*	*	*		



SECTION III REPAIR PARTS FOR DIRECT SUPPORT, GENERAL SUPPORT, AND DEPOT MAINTENANCE (CONTINUED)

(1) SIB CODE	(2) FEDERAL STOCK NUMBER	(3) DESCRIPTION  REFERENCE NUMBER & MFR. CODE	(4) UNIT OF MEAS	(5) QTY REQ IN UNIT	(6) 30-DAY GS MAINT ALLOWANCE			(7) 90-DAY GS MAINT ALLOWANCE			(8) 1 YR ALM PER EQUIP CNTYCY	(9) DEPOT MAINT ALM PER 100 EQUIP	(10) ILLUSTRATIONS	
					(a)	(b)	(c)	(a)	(b)	(c)			(a)	(b)
					1-20	21-60	61-100	1-20	21-60	61-100			FIG NO.	ITEM NO. OR REFERENCE DESIGNATION
M-R		INSULATION SLEEVING, ELECTRICAL MIL13190C1BA1S12R4-0 (81349)	FT	REF										
XI-F		PLATE, DESIGNATION MEX6-140 (71789)	EA	1										
P-F	5305-763-6962	SCREW, MACHINE MS51959-27 (96906)	EA	REF	*	*	*	*	*	*	*	*		
XI-F		BOARD ASSEMBLY 543-3416-002 (13499)	EA	1										
X2-F		BOARD, INSULATION 543-3415-002 (13499)	EA	1										
P-F	5310-061-9245	POST, SPACING 540-9037-003 (13499)	EA	REF	*	*	*	*	*	*	*	*		
P-F	5305-054-5652	SCREW, MACHINE MS51957-18 (96906)	EA	REF	*	*	*	*	*	*	*	*		
P-R	5310-857-5548	NUT, SELF-LOCKING, HEXAGON MS21044D04 (96906)	EA	REF	*	*	*	*	*	*	*	*		
XI-O		PLATE, SHORTING 543-3410-002 (13499)	EA	1										
XI-O		PLATE, SHORTING 543-3411-002 (13499)	EA	1										
P-O		KIT, MOUNTING 541-1477-002 (13499)	EA	REF	*	*	*	*	*	*	*	*		
M-R		BAG, COTTON 024-0100-000 (13499)	EA	REF										
P-O	5310-054-1830	WASHER, LOCK MS39338-80 (96906)	EA	REF	*	*	*	*	*	*	*	*		
P-O		WASHER, FLAT 310-0167-000 (79807)	EA	REF	*	*	*	*	*	*	*	*		
P-O		WASHER, LOCK 310-0286-000 (13499)	EA	REF	*	*	*	*	*	*	*	*		
P-C	5305-579-3507	SCREW, MACHINE MS39216-40 (96906)	EA	REF	*	*	*	*	*	*	*	*		
P-O		SCREW, MACHINE P343-0247-000 (77250)	EA	REF	*	*	*	*	*	*	*	*		
M-R		TERMINAL, LUG MS29036-2 (96906)	EA	REF										
P-R	5940-246-3853	TERMINAL, LUG 32442 (00779)	EA	REF				*	*	*	*	*		
M-R		WIRE, ELECTRICAL SUC7249906 (90484)	FT	REF										
		GROUP CG - COMPARATOR ASSEMBLY CG-126/UR												
A-O-B		COMPARATOR ASSEMBLY CG-126/UR 522-1074-000 (13499)	EA	1									3-1	1A8
M-D		PLATE, IDENTIFICATION 280-1254-000 (12998)	EA	REF										
M-D		PLATE, IDENTIFICATION 546-7991-002 (13499)	EA	1										
P-F		SCREW, TAPPING, THREAD 231-09490778CANPL (45722)	EA	REF	*	*	*	*	*	*	*	*		
P-F		SCREW, MACHINE P343-0298-000 (77250)	EA	12	*	*	*	*	*	*	*	*		

SECTION III REPAIR PARTS FOR DIRECT SUPPORT, GENERAL SUPPORT, AND DEPOT MAINTENANCE (CONTINUED)

(1) SIR CODE	(2) FEDERAL STOCK NUMBER	(3) DESCRIPTION  REFERENCE NUMBER & MIL. CODE  USABLE ON CODE	(4) UNIT OF MEAS.	(5) QTY INC. IN UNIT	(6) 30-DAY DS MAINT ALLOWANCE			(7) 30-DAY GS MAINT ALLOWANCE			(8) 1 YR ALW PER EQUIP CRNCY	(9) DEPOT MAINT ALW PER 100 EQUIP	(10) ILLUSTRATIONS	
					(a)	(b)	(c)	(a)	(b)	(c)			(a)	(b)
					1-20	21-50	51-100	1-20	21-50	51-100			FIG NO.	ITEM NO. OR REFERENCE DESIGNATION
P-F	5305-054-665	SCREW, MACHINE MS51957-27 (96906)	EA	REF	*	*	*	*	*	*	*			
P-F	5310-209-1366	WASHER, LOCK MS35335-58 (96906)	EA	REF	*	*	*	*	*	*	*			
X2-F		FRAME ASSEMBLY 540-6334-004 (13499)	EA	3										
P-F		SETSCREW 10-32X5-86SPLINE416SST (08664)	EA	REF	*	*	*	*	*	*	*			
P-F	5305-765-4346	SCREW, MACHINE MS51959-35 (96906)	EA	REF	*	*	*	*	*	*	*			
P-F	5305-765-4257	SCREW, MACHINE MS51959-43 (96906)	EA	REF	*	*	*	*	*	*	*			
P-F	5305-054-6650	SCREW, MACHINE MS51957-26 (96906)	EA	REF	*	*	*	*	*	*	*			
P-F	5305-579-3513	SCREW, MACHINE MS35217-55 (96906)	EA	REF	*	*	*	*	*	*	*			
P-F	5310-209-1366	WASHER, LOCK MS35335-58 (96906)	EA	REF	*	*	*	*	*	*	*			
P-F	5310-054-1831	WASHER, LOCK MS35338-81 (96906)	EA	REF	*	*	*	*	*	*	*			
P-F		POST, STANDOFF 561-2189-002 (13499)	EA	REF	*	*	*	*	*	*	*			
P-F	5315-791-7836	SCREW, EXTERNALLY RELIEVED BODY 540-6241-002 (13499)	EA	REF	*	*	*	*	*	*	*			
X1-F		BLOCK, SPACER 540-6240-002 (13499)	EA	REF										
X2-F		PLATE, HINGE 540-6240-002 (13499)	EA	REF										
X2-F		PLATE, PIVOT 540-6434-002 (13499)	EA	REF										
P-F	5340-634-7444	RING, RETAINING MS16632-1018 (96906)	EA	REF	*	*	*	*	*	*	*			
X1-F		BUMPER 561-2190-002 (13499)	EA	6										
A-F		PLATE, HINGE 540-6258-002 (13499)	EA	3										
X1-H		PIN, GROOVED 541-3627-002 (13499)	EA	REF										
X1-F		PLATE, HINGE 540-6234-002 (13499)	EA	3										
X1-F		BLOCK, CENTER 540-6252-003 (13499)	EA	3										
X2-F		FRAME-STAKED 540-6328-004 (13499)	EA	3										
P-R		NUT, PLAIN, HEXAGON 540-6244-002 (13499)	EA	REF				*	*	*	*			
X2-F		FRAME-SPOTWELDED 540-6316-004 (13499)	EA	3										
X1-F		CHANNEL, CHASSIS 540-6300-004 (13499)	EA	REF										
X1-F		CHANNEL, CHASSIS 540-6301-004 (13499)	EA	REF										
X2-F		BRACKET, END 540-6283-003 (13499)	EA	3										

SECTION III REPAIR PARTS FOR DIRECT SUPPORT, GENERAL SUPPORT, AND DEPOT MAINTENANCE (CONTINUED)

(1) SIC CODE	(2) FEDERAL STOCK NUMBER	(3) DESCRIPTION  REFERENCE NUMBER & MFR. CODE	(4) UNIT OF MEAS	(5) QTY REQ IN UNIT	(6) 30-DAY GS MAINT ALLOWANCE			(7) 30-DAY GS MAINT ALLOWANCE			(8) 1 YR ALM PER EQUIP CNTGTY	(9) DEPOT MAINT ALM PER 100 EQUIP	(10) ILLUSTRATIONS		
					USABLE ON CODE	(a) 1-20	(b) 21-50	(c) 51-100	(a) 1-20	(b) 21-50			(c) 51-100	(a) FIG NO.	(b) ITEM NO. OR REFERENCE DESIGNATION
P-O	5960-792-7432	ELECTRON, TUBE 3B2WA (49671)	EA	1	*	*	*	*	*	*	*	*	3-47	1ABV1	
P-O	5960-556-1332	ELECTRON TUBE 6BB6 (49671)	EA	1	*	*	*	*	*	*	*	*	3-47	1ABV2	
P-F	5960-564-4772	SHIELD ASSEMBLY 541-6551-003 (13499)	EA	1	*	*	*	*	*	*	*	*		1ABE6	
P-F	5960-581-8696	SHIELD, ELECTRON 120-0P1001 (91662) - OR -	EA	REF	*	*	*	*	*	*	*	*			
P-F	5960-614-8676	SHIELD, ELECTRON 541-8169-002 (13499)	EA	REF	*	*	*	*	*	*	*	*			
XI-F		SHIELD 541-8158-002 (13499)	EA	REF											
P-F	5340-769-2240	SPRING, HELICAL 541-8163-002 (13499)	EA	REF	*	*	*	*	*	*	*	*			
XI-F		RETAINER 541-6518-002 (13499)	EA	REF											
P-H		SHIELD ASSEMBLY 541-6552-003 (13499)	EA	1				*	*	*	*	*		1ABE7	
XI-F		SHIELD, ELECTRON 149-0P1001 (91662) - OR -	EA	1											
XI-F		SHIELD, ELECTRON 541-8168-002 (13499)	EA	1											
XI-F		SHIELD 541-8159-002 (13499)	EA	1											
P-F	5340-769-2240	SPRING, HELICAL 541-8163-002 (13499)	EA	REF	*	*	*	*	*	*	*	*			
P-H	5960-617-5790	RETAINER 541-6519-002 (13499)	EA	1				*	*	*	*	*		1ABE9	
M-D		PLATE, IDENTIFICATION 280-0450-000 (74048)	EA	REF											
A-O		PLATE ASSEMBLY 543-4391-000 (13499)	EA	1											
P-F		SCREW, MACHINE P342-0024-000 (77250)	EA	REF	*	*	*	*	*	*	*	*			
P-F		SCREW, MACHINE P343-0331-000 (77250)	EA	REF	*	*	*	*	*	*	*	*			
P-F	5305-054-5648	SCREW, MACHINE MS51957-14 (96906)	EA	REF	*	*	*	*	*	*	*	*			
P-F	5305-054-5647	SCREW, MACHINE MS51957-13 (96906)	EA	REF	*	*	*	*	*	*	*	*			
P-F		SCREW, MACHINE P343-0284-000 (77250)	EA	REF	*	*	*	*	*	*	*	*			
P-F		SCREW, MACHINE P343-0329-000 (77250)	EA	REF	*	*	*	*	*	*	*	*			
P-F	5310-209-6069	WASHER, LOCK X10-0077-000 (79807)	EA	REF	*	*	*	*	*	*	*	*			
P-F		WASHER, LOCK 1720-02CADFL (78189)	EA	REF	*	*	*	*	*	*	*	*			
P-H		WASHER, LOCK X10-0076-000 (79807)	EA	REF				*	*	*	*	*			
P-F		NUT, PLAIN, HEXAGON P313-0140-000 (77250)	EA	REF	*	*	*	*	*	*	*	*			
P-F		NUT, PLAIN, HEXAGON P313-0132-000 (77250)	EA	REF	*	*	*	*	*	*	*	*			

SECTION III REPAIR PARTS FOR DIRECT SUPPORT, GENERAL SUPPORT, AND DEPOT MAINTENANCE (CONTINUED)

(1) SIR CODE	(2) FEDERAL STOCK NUMBER	(3) DESCRIPTION  REFERENCE NUMBER & VER. CODE	(4) UNIT OF MEAS.	(5) QTY INC IN UNIT	(6) 30-DAY GS MAINT ALLOWANCE			(7) 30-DAY GS MAINT ALLOWANCE			(8) 1 YR ALMPER EQUIP CENCY	(9) DEPOT MAINT ALMPER 100 EQUIP	(10) ILLUSTRATIONS	
					(a) 1-20	(b) 21-50	(c) 51-100	(a) 1-20	(b) 21-50	(c) 51-100			(a) FIG NO.	(b) ITEM NO. OR REFERENCE DESIGNATION
P-F		NUT, PLAIN, HEXAGON P334-4120-000 (77250)	EA	REF	*	*	*	*	*	*	*			
P-H		POST-PANEL 541-0163-002 (13499)	EA	REF				*	*	*	*			
P-F	5355-079-9556	KNOB-MODIFIED 547-1330-002 (13499)	EA	1	*	*	*	*	*	*	*			
XI-F		KNOB 1400XBLK (72512)	EA	1								3-47	1A801	
P-H		BUSHING AND NUT UB241N1PL (37942)	EA	REF				*	*	*	*			
M-H		INSULATION SLEEVING, ELECTRICAL 152-1743-000 (13499)	FT	REF										
M-H		INSULATION SLEEVING, ELECTRICAL TEFTW12B (81851)	FT	REF										
P-F		GROMMET, RUBBER 905 (75543)	EA	REF	*	*	*	*	*	*	*			
P-F		TERMINAL, STUD 2B10B12 (92825)	EA	6	*	*	*	*	*	*	*		1A8E10	
P-F		TERMINAL, STUD 2B10B12 (92825)	EA	REF	*	*	*	*	*	*	*		1A8E11	
P-F		TERMINAL, STUD 2B10B12 (92825)	EA	REF	*	*	*	*	*	*	*		1A8E12	
P-F		TERMINAL, STUD 2B10B12 (92825)	EA	REF	*	*	*	*	*	*	*		1A8E13	
P-F		TERMINAL, STUD 2B10B12 (92825)	EA	REF	*	*	*	*	*	*	*		1A8E14	
P-F		TERMINAL, STUD 2B10B12 (92825)	EA	REF	*	*	*	*	*	*	*		1A8E16	
P-F		TERMINAL, STUD 2A1DB12 (92825)	EA	1	*	*	*	*	*	*	*		1A8E15	
P-F	5935-302-5754	STRAP-SHIELD 502-1427-002 (13499)	EA	1	*	*	*	*	*	*	*			
P-F		INSULATION SLEEVING, ELECTRICAL TEFTW22B (81851)	FT	REF	*	*	*	*	*	*	*			
P-F		TERMINAL, LUG 2104-06-02-2520N (78189)	EA	REF	*	*	*	*	*	*	*			
P-F	5935-260-0516	SOCKET, ELECTRON TS102P01 (81349)	EA	2	*	*	*	*	*	*	*	3-48	1A8SV1	
P-F	5935-260-0516	SOCKET, ELECTRON TS102P01 (81349)	EA	REF	*	*	*	*	*	*	*	3-48	1A8SV2	
P-F	593-853-7596	CONNECTOR, RECEPTACLE, ELECTRICAL UG1094U (80058)	EA	2	*	*	*	*	*	*	*	3-48	1A8J1	
P-F	5935-853-7596	CONNECTOR, RECEPTACLE, ELECTRICAL UG1094U (80058)	EA	REF	*	*	*	*	*	*	*	3-48	1A8J2	
P-F		CONNECTOR, RECEPTACLE, ELECTRICAL ME35179-1094A (96906)	EA	2	*	*	*	*	*	*	*	3-48	1A8J1	
P-F		CONNECTOR, RECEPTACLE, ELECTRICAL ME35179-1094A (96906)	EA	REF	*	*	*	*	*	*	*	3-48	1A8J2	
P-F	5905-949-0795	RESISTOR, VARIABLE KB22200 (71450)	EA	1	*	*	*	*	*	*	*	3-47	1A8R8	
P-F	5905-844-8297	RESISTOR, VARIABLE KB22199 (71450)	EA	1	*	*	*	*	*	*	*	3-47	1A8R2	
P-H	6625-649-3228	AMMETER 458-0108-000 (13499)	EA	1				*	*	*	*	3-47	1A8R1	

SECTION III REPAIR PARTS FOR DIRECT SUPPORT, GENERAL SUPPORT, AND DEPOT MAINTENANCE (CONTINUED)

(1) SIR CODE	(2) FEDERAL STOCK NUMBER	(3) DESCRIPTION  REFERENCE NUMBER & MFR. CODE	(4) USABLE ON CODE	(5) UNIT OF MEAS  QTY INC IN UNIT	(6) 30-DAY DS MAINT ALLOWANCE			(7) 30-DAY GS MAINT ALLOWANCE			(8) 1 YR ALW PER EQUIP CWTQCY	(9) DEPOT MAINT ALW PER 100 EQUIP	(10) ILLUSTRATIONS	
					(a) 1-20	(b) 21-50	(c) 51-100	(a) 1-20	(b) 21-50	(c) 51-100			(a) FIG NO.	(b) ITEM NO. OR REFERENCE DESIGNATION
					P-F	5930-679-9487	SWITCH, ROTARY 18924F3 (76894)		EA	1			*	*
P-F	5950-679-9488	TRANSFORMER, AUDIO, FREQUENCY 25763 (73386)		EA	1	*	*	*	*	*	*	*	3-47	1AB81
P-F	5905-542-7667	RESISTOR, FIXED, FILM RN60B1151F (81349)		EA	1	*	*	*	*	*	*	*	3-48	1AB81
P-F	5905-192-0390	RESISTOR, FIXED, COMPOSITION RC20GF105K (81349)		EA	1	*	*	*	*	*	*	*	3-48	1AB83
P-F	5905-171-2002	RESISTOR, FIXED, COMPOSITION RC20GF470K (81349)		EA	1	*	*	*	*	*	*	*	3-48	1AB84
P-F	5905-060-2481	RESISTOR, FIXED, FILM RN65D6811F (81349)		EA	1	*	*	*	*	*	*	*	3-48	1AB85
P-H	5905-064-0555	RESISTOR, FIXED, FILM RN65D1002F (81349)		EA	1	*	*	*	*	*	*	*	3-48	1AB86
P-F	5905-993-6012	RESISTOR, FIXED, FILM RN65D1471F (81349)		EA	1	*	*	*	*	*	*	*	3-48	1AB87
P-F	5905-299-2012	RESISTOR, FIXED, COMPOSITION RC32GF362K (81349)		EA	1	*	*	*	*	*	*	*	3-48	1AB89
P-H	5905-256-0387	RESISTOR, FIXED, COMPOSITION RC20GF681K (81349)		EA	1	*	*	*	*	*	*	*	3-48	1AB810
P-F	5910-822-5683	CAPACITOR, FIXED, CERAMIC DIELECTRIC CK63AF103M (81349)		EA	2	*	*	*	*	*	*	*	3-48	1AB81
P-F	5910-822-5683	CAPACITOR, FIXED, CERAMIC DIELECTRIC CK63AF103M (81349)		EA	REF	*	*	*	*	*	*	*		1AB82
P-F	5910-649-0544	CAPACITOR, FIXED, PAPER DIELECTRIC S181K03154M (53021)		EA	1	*	*	*	*	*	*	*	3-48	1AB83
P-F	5910-556-1425	CAPACITOR, FIXED, CERAMIC DIELECTRIC 33C2 (01939)		EA	1	*	*	*	*	*	*	*	3-48	1AB84
M-R		WIRE, ELECTRICAL M1LW16878TYEB22-9 (81349)		FT	REF									
M-R		WIRE, ELECTRICAL 00702-1322 (70367)		FT	REF									
M-R		INSULATION SLEEVING, ELECTRICAL TEPTW20B (81851)		FT	REF									
M-R		INSULATION SLEEVING, ELECTRICAL TEPTW11B (81851)		FT	REF									
M-R		INSULATION SLEEVING, ELECTRICAL TEPTW18B (81851)		FT	REF									
P-R		CORD, NYLON 435-1014-000 (13499)		FT	REF									
M-R		CLAMP, LOOP HP9W (09922)		EA	REF									
P-F		WASHER, FLAT 310-6360-000 (79807)		EA	REF	*	*	*	*	*	*	*		
P-F	5305-054-6625	SCREW, MACHINE ME31997-28 (96906)		EA	REF	*	*	*	*	*	*	*		
P-F		WASHER, LOCK 310-0082-000 (79807)		EA	REF	*	*	*	*	*	*	*		
X2-F		PLATE-ADAPTER 344-9436-002 (13499)		EA	1									
P-F		NUT, CAPTIVE N0N6-2-2-1 (07886)		EA	REF	*	*	*	*	*	*	*		
X2-F		PLATE-ADAPTER 344-9435-002 (13499)		EA	1									

SECTION III REPAIR PARTS FOR DIRECT SUPPORT, GENERAL SUPPORT, AND DEPOT MAINTENANCE (CONTINUED)

(1) SR CODE	(2) FEDERAL STOCK NUMBER	(3) DESCRIPTION  REFERENCE NUMBER & MFR. CODE	(4) UNIT OF MEAS	(5) QTY INC IN UNIT	(6) 30-DAY DS MAINT ALLOWANCE			(7) 30-DAY GS MAINT ALLOWANCE			(8) 1 YR ALM PER EQUIP CENTQY	(9) DEPOT MAINT ALM PER 100 EQUIP	(10) ILLUSTRATIONS	
					(a) 1-20	(b) 21-50	(c) 51-100	(a) 1-20	(b) 21-50	(c) 51-100			(a) FIG NO.	(b) ITEM NO. OR REFERENCE DESIGNATION
P-F	5935-681-4305	CONNECTOR, RECEPTACLE, ELECTRICAL 26-4405-16S (02660)	EA	1	*	*	*	*	*	*	*	*	3-48	1A8J4
P-F	5310-058-3599	WASHER, LOCK MS35335-57 (96906)	EA	REF	*	*	*	*	*	*	*	*		
P-F		NUT, PLAIN, HEXAGON P313-0045-000 (77250)	EA	REF	*	*	*	*	*	*	*	*		
X2-F		PANEL-CONTROL 543-4395-003 (13499)	EA	3										
X2-F		PLATE-FRONT 543-4407-004 (13499)	EA	1										
X2-F		PLATE-FRONT 543-4406-004 (13499)	EA	1										
P-F	5935-538-3069	JACK, TIP SKT1 (98291)	EA	1	*	*	*	*	*	*	*	*	3-47	1A8J3
P-F		TERMINAL, LUG 304-0320-000 (13499)	EA	5	*	*	*	*	*	*	*	*		
A-F		CABLE FREQUENCY COMPARATOR 543-4392-000 (13499)	EA	1										
M-H		WIRE, ELECTRICAL MILW16878TYPEB22-9 (81349)	FT	REF										
M-H		WIRE, ELECTRICAL MILW16878TYPEB22-90 (81349)	FT	REF										
M-H		WIRE, ELECTRICAL MILW16878TYPEB22-91 (81349)	FT	REF										
M-H		WIRE, ELECTRICAL MILW16878TYPEB22-92 (81349)	FT	REF										
M-H		WIRE, ELECTRICAL MILW16878TYPEB22-93 (81349)	FT	REF										
M-H		WIRE, ELECTRICAL MILW16878TYPEB22-902 (81349)	FT	REF										
M-H		WIRE, ELECTRICAL MILW16878TYPEB22-905 (81349)	FT	REF										
M-H		WIRE, ELECTRICAL MILW16878TYPEB22-906 (81349)	FT	REF										
M-H		WIRE, ELECTRICAL MILW16878TYPEB22-912 (81349)	FT	REF										
M-H		WIRE, ELECTRICAL MILW16878TYPEB22-922 (81349)	FT	REF										
M-H		WIRE, ELECTRICAL MILW16878TYPEB22-923 (81349)	FT	REF										
M-H		WIRE, ELECTRICAL MILW16878TYPEB22-926 (81349)	FT	REF										
P-H		WIRE, ELECTRICAL MILW16878TYPEB22-956 (81349)	FT	REF				*	*	*	*	*		
M-H		CABLE, SPECIAL PURPOSE, ELECTRICAL 1SBUB730N90 (90484)	FT	REF										
M-H		CABLE, SPECIAL PURPOSE, ELECTRICAL 1SBUB730N91 (90484)	FT	REF										
M-H		CABLE, SPECIAL PURPOSE, ELECTRICAL 1SBUB730N92 (90484)	FT	REF										
M-H		CABLE, SPECIAL PURPOSE, ELECTRICAL 1SBUB730N93 (90484)	FT	REF										

SECTION III REPAIR PARK FOR DIRECT SUPPORT, GENERAL SUPPORT, AND DEPOT MAINTENANCE (CONTINUED)

(1) SIR CODE	(2) FEDERAL STOCK NUMBER	(3) DESCRIPTION  REFERENCE NUMBER & MFR. CODE	(4) UNIT OF MEAS	(5) QTY INC IN UNIT	(6) 30-DAY GS MAINT ALLOWANCE			(7) 30-DAY GS MAINT ALLOWANCE			(8) 1 YR ALW PER EQUIP CNTGCTY	(9) DEPOT MAINT ALW PER 100 EQUIP	(10) ILLUSTRATIONS	
					(a) 1-20	(b) 21-50	(c) 51-100	(a) 1-20	(b) 21-50	(c) 51-100			(a) FIG NO.	(b) ITEM NO. OR REFERENCE DESIGNATION
M-H		CABLE, SPECIAL PURPOSE, ELECTRICAL 1SBUB730N95 (90484)	FT	REF										
P-F	5940-113-8184	TERMINAL, LUG MS25036-50 (96906)	EA	4	*	*	*	*	*	*	*			
M-H		INSULATION SLEEVING, ELECTRICAL TEFTW88 (81851)	FT	REF										
P-H		CORD, NYLON 435-1014-000 (13499)	FT	REF				*	*	*	*			
P-F	5940-812-1668	FERRULE, RADIO FREQUENCY GROUNDING GSB063 (59730)	EA	REF	*	*	*	*	*	*	*			
P-F	5940-280-3829	FERRULE, RADIO FREQUENCY GROUNDING GSCL28 (59730)	EA	REF	*	*	*	*	*	*	*			
M-H		WIRE, ELECTRICAL 00702-1320 (70567)	FT	REF										
P-F		SETScrew 335-0041-000 (08664)	EA	REF	*	*	*	*	*	*	*			
P-F	5355-668-5311	KNOB 1450WBLK (72512)	EA	2	*	*	*	*	*	*	*		3-47	1A802
P-F	5355-668-5311	KNOB 1450WBLK (72512)	EA	REF	*	*	*	*	*	*	*		3-47	1A803
A-H		COVER, RIVETED 543-4403-004 (13499)	EA	3										
X2-H		COVER, SPOTWELDED 543-4402-004 (13499)	EA	3										
X1-H		CATCH, FLUSH H460D040-250 (83014)	EA	REF										
X1-H		RIVET, TUBULAR R3484X1-8CADPL (12014)	EA	REF										
X2-H		COVER-HEAR 543-4400-003 (13499)	EA	2										
		GROUP 09 - INTERCONNECTING BOX 153H-3												
A-O-R		INTERCONNECTING BOX 153H-3 522-2363-005 (13499)	EA	1									3-1	1A1
M-H		BAG, CUTTON 024-2000-000 (13499)	EA	1										
P-F	5340-664-6732	CLAMP, LOOP HPL4N (09922)	EA	9	*	*	*	*	*	*	*			
M-H		INSULATION SLEEVING, ELECTRICAL FUAB113-8A (81349)	FT	1										
M-D		PLATE, IDENTIFICATION 280-0450-000 (74048)	EA	REF										
M-D		PLATE, IDENTIFICATION 280-1254-000 (12998)	EA	REF										
M-D		PLATE, IDENTIFICATION 547-1330-002 (13499)	EA	1										
P-F	5310-209-1074	WASHER, FLAT 310-0048-000 (79807)	EA	REF	*	*	*	*	*	*	*			
P-F	5310-058-2950	WASHER, LOCK MS35337-77 (96906)	EA	REF	*	*	*	*	*	*	*			
P-F	5310-043-1754	WASHER, LOCK MS35337-79 (96906)	EA	REF	*	*	*	*	*	*	*			

SECTION III REPAIR PARTS FOR DIRECT SUPPORT, GENERAL SUPPORT, AND DEPOT MAINTENANCE (CONTINUED)

(1) SMR CODE	(2) FEDERAL STOCK NUMBER	(3) DESCRIPTION  REFERENCE NUMBER & MFR. CODE	(4) LIMIT OF MEAS	(5) QTY INC IN LIMIT	(6) 30-DAY DS MAINT ALLOWANCE			(7) 30-DAY GS MAINT ALLOWANCE			(8) 1 YR ALM PER EQUIP (NTCY)	(9) DEPOT MAINT ALM PER 100 EQUIP	(10) ILLUSTRATIONS	
					(a) 1-20	(b) 21-50	(c) 51-100	(a) 1-20	(b) 21-50	(c) 51-100			(a) FIG NO.	(b) ITEM NO. OR REFERENCE DESIGNATION
P-F	5310-054-1830	WASHER, LOCK MS35338-80 (96906)	EA	REF	*	*	*	*	*	*	*	*		
P-F	5310-042-9609	WASHER, LOCK MS35338-78 (96906)	EA	REF	*	*	*	*	*	*	*	*		
P-F		WASHER, LOCK 310-0286-000 (13499)	EA	REF	*	*	*	*	*	*	*	*		
P-F		NUT, PLAIN, HEXAGON P313-0045-000 (77250)	EA	REF	*	*	*	*	*	*	*	*		
P-F		NUT, PLAIN, HEXAGON P313-0046-000 (77250)	EA	9	*	*	*	*	*	*	*	*		
P-F		SCREW, TAPPING, THREAD 2XL-SPANDHTYPECADPL (45722)	EA	REF	*	*	*	*	*	*	*	*		
P-F	5305-763-6963	SCREW, MACHINE MS51959-28 (96906)	EA	REF	*	*	*	*	*	*	*	*		
P-F	5305-054-5635	SCREW, MACHINE MS51957-1 (96906)	EA	REF	*	*	*	*	*	*	*	*		
P-F	5305-054-5647	SCREW, MACHINE MS51957-13 (96906)	EA	REF	*	*	*	*	*	*	*	*		
P-F	5305-579-3507	SCREW, MACHINE MS35216-40 (96906)	EA	REF	*	*	*	*	*	*	*	*		
P-F		SCREW, MACHINE P343-1108-000 (77250)	EA	4	*	*	*	*	*	*	*	*		
XI-F		COVER, JUNCTION 547-1340-004 (13499)	EA	1										
XI-F		STUD ASSEMBLY, TURNLOCK 2600-8 (71286)	EA	2										
P-H	5310-337-8329	PUSH ON NUT 2600LN (71286)	EA	REF				*	*	*	*	*		
X2-H		COVER 547-1339-004 (13499)	EA	1										
XI-H		ROD, TIE 543-2552-002 (13499)	EA	1										
X2-H		BRACKET, ANGLE 544-2697-002 (13499)	EA	1										
X2-H		CHANNEL-FRONT 544-2699-002 (13499)	EA	1										
X2-H		BRACKET, LEFT 544-2703-003 (13499)	EA	1										
X2-H		BRACKET 544-2701-003 (13499)	EA	1										
P-H	5325-505-4798	RECEPTACLE, TURNLOCK 212-12 (71286)	EA	REF				*	*	*	*	*		
XI-H		RIVET, SOLID MS20426AD3-5 (96906)	EA	4										
X2-H		BRACKET, RIGHT 544-2704-003 (13499)	EA	1										
P-H	5325-505-4798	RECEPTACLE, TURNLOCK 212-12 (71286)	EA	REF				*	*	*	*	*		
XI-H		RIVET, SOLID MS20426AD3-5 (96906)	EA	REF										
X2-H		BRACKET 544-2702-003 (13499)	EA	1										
P-F	5305-054-6652	SCREW, MACHINE MS51957-28 (96906)	EA	REF	*	*	*	*	*	*	*	*		



SECTION III REPAIR PARTS FOR DIRECT SUPPORT, GENERAL SUPPORT, AND DEPOT MAINTENANCE (CONTINUED)

(1) SIR CODE	(2) FEDERAL STOCK NUMBER	(3) DESCRIPTION  REFERENCE NUMBER & MFR. CODE	(4) UNIT OF MEAS.	(5) QTY INC. IN UNIT	(6) 30-DAY DS MAINT ALLOWANCE			(7) 30-DAY GS MAINT ALLOWANCE			(8) 1 YR ALM PER EQUIP CNTGTY	(9) DEPOT MAINT ALM PER 100 EQUIP	(10) ILLUSTRATIONS	
					(a) 1-20	(b) 21-50	(c) 51-100	(a) 1-20	(b) 21-50	(c) 51-100			(a) FIG NO.	(b) ITEM NO. OR REFERENCE DESIGNATION
A-O		RELAY, THERMAL-RECEIVER 547-1324-000 (13499)	EA	1										
P-F	5930-823-0146	SWITCH, PUSH C3100E3R (81640)	EA	1	*	*	*	*	*	*	*	3-49	1A1S1	
P-O	6240-179-1811	LAMP, GLOW MEZ (08805)	EA	1	*	*	*	*	*	*	*	3-49	1A1DS2	
P-O	6210-688-5543	LENS, INDICATOR LIGHT 61-111FC (72619)	EA	1	*	*	*	*	*	*	*		1A1E1	
P-F	6210-023-8555	LAMPHOLDER 50 (72765)	EA	1	*	*	*	*	*	*	*	3-49	1A1DS1	
P-O	6240-155-8714	LAMP, INCANDESCENT MS15571-4 (96906)	EA	1	*	*	*	*	*	*	*	3-49	1A1DS1	
P-F	5920-552-0269	FUSEHOLDER PH12G (81349)	EA	2	*	*	*	*	*	*	*	3-49	1A1XF1	
P-F	5920-552-0269	FUSEHOLDER PH12G (81349)	EA	REF	*	*	*	*	*	*	*	3-49	1A1XF2	
P-H		TERMINAL, LUG 2104-04-01-2520M (78189)	EA	REF										
P-F		TERMINAL, LUG 2041-10-032-HOTTINNED (77147)	EA	4	*	*	*	*	*	*	*			
P-F	5940-259-8457	TERMINAL, STUD RHE12M (91663)	EA	REF	*	*	*	*	*	*	*			
P-F	5940-854-8717	TERMINAL, STUD RHE12-2M (91663)	EA	3	*	*	*	*	*	*	*		1A1E3	
P-F	5940-854-8717	TERMINAL, STUD RHE12-2M (91663)	EA	REF	*	*	*	*	*	*	*		1A1E4	
P-F	5940-854-8717	TERMINAL, STUD RHE12-2M (91663)	EA	REF	*	*	*	*	*	*	*		1A1E5	
P-F	5310-058-3829	WASHER, LOCK MS3933B-77 (96906)	EA	REF	*	*	*	*	*	*	*			
P-F	5310-934-9748	NUT, FLAIN, HEXAGON MS39449-44 (96906)	EA	REF	*	*	*	*	*	*	*			
P-F		SCREW, MACHINE P330-2290-000 (77250)	EA	REF	*	*	*	*	*	*	*			
P-F		SCREW, MACHINE P330-2292-000 (77250)	EA	10	*	*	*	*	*	*	*			
P-F		NUT, FLAIN, HEXAGON P334-0259-000 (77250)	EA	REF	*	*	*	*	*	*	*			
P-F		SCREW, MACHINE P342-0191-000 (77250)	EA	REF	*	*	*	*	*	*	*			
P-H	5305-054-5636	SCREW, MACHINE MS51957-2 (96906)	EA	REF	*	*	*	*	*	*	*			
P-F	5305-054-5647	SCREW, MACHINE MS51957-13 (96906)	EA	REF	*	*	*	*	*	*	*			
P-F	5935-853-7598	CONNECTOR, RECEPTACLE, ELECTRICAL UG1094U (80098)	EA	2	*	*	*	*	*	*	*	3-49	1A1J2	
P-F	5935-853-7596	CONNECTOR, RECEPTACLE, ELECTRICAL UG1094U (80098)	EA	REF	*	*	*	*	*	*	*		1A1J3	
P-F		CONNECTOR, RECEPTACLE, ELECTRICAL MS39179-1094A (96906)	EA	2	*	*	*	*	*	*	*	3-49	1A1J2	
P-F		CONNECTOR, RECEPTACLE, ELECTRICAL MS39179-1094A (96906)	EA	REF	*	*	*	*	*	*	*		1A1J3	
P-F		WASHER, LOCK 1714-05CAF1 (78189)	EA	REF	*	*	*	*	*	*	*			

SECTION III REPAIR PARTS FOR DIRECT SUPPORT, GENERAL SUPPORT, AND DEPOT MAINTENANCE (CONTINUED)

(1) SIB CODE	(2) FEDERAL STOCK NUMBER	(3) DESCRIPTION  REFERENCE NUMBER, % WPL., QTY.	(4) UNIT OF MEAS	(5) QTY INC IN UNIT	(6) 30-DAY DS MAINT ALLOWANCE			(7) 30-DAY GS MAINT ALLOWANCE			(8) 1 YR ALM PER EQUIP CONTACT	(9) DEPOT MAINT ALM PER 100 EQUIP	(10) ILLUSTRATIONS	
					(a)	(b)	(c)	(a)	(b)	(c)			(a)	(b)
					1-20	21-50	51-100	1-20	21-50	51-100			FIG NO.	ITEM NO. OR REFERENCE DESIGNATION
P-F	5310-058-3599	WASHER, LOCK MS35335-57 (96906)	EA	REF	*	*	*	*	*	*	*			
P-F	5945-448-5833	RELAY, THERMAL GS3905 (93929)	EA	1	*	*	*	*	*	*	*	3-49	1A1K2	
P-F	5945-448-5836	SWITCH, RADIO FREQUENCY TRANSMISSION 300-11796 (74868)	EA	1	*	*	*	*	*	*	*	3-49	1A1K1	
M-H		WIRE, ELECTRICAL 00702-1320 (70567)	FT	REF										
M-H		WIRE, ELECTRICAL MILW16878TYPB22-9 (81349)	FT	REF										
M-H		WIRE, ELECTRICAL MILW16878TYPB22-92 (81349)	FT	REF										
M-H		WIRE, ELECTRICAL MILW16878TYPB22-95 (81349)	FT	REF										
M-H		WIRE, ELECTRICAL MILW16878TYPB22-96 (81349)	FT	REF										
X1-H		BUS BAR 547-1325-002 (13499)	EA	1										
X2-H		BRACKET, MOUNTING 547-1326-002 (13499)	EA	1										
A-F		CABLE ASSEMBLY NUMBER 1 547-1329-002 (13499)	EA	1										1A1W1
P-F	5935-835-0508	CONNECTOR, PLUG, ELECTRICAL MS35168-88E (96906)	ZA	4	*	*	*	*	*	*	*			1A1P3
P-F	5935-835-0508	CONNECTOR, PLUG, ELECTRICAL MS35168-88E (96906)	EA	REF	*	*	*	*	*	*	*			1A1P5
M-H		CABLE, RADIO FREQUENCY RG58CU (80058)	FT	REF										
A-F		CABLE ASSEMBLY NUMBER 2 547-1328-002 (13499)	EA	1										1A1W2
P-F	5935-835-0508	CONNECTOR, PLUG, ELECTRICAL MS35168-88E (96906)	EA	REF	*	*	*	*	*	*	*			1A1P4
P-F	5935-810-3767	CONNECTOR, RECEPTACLE, ELECTRICAL UO909BU (80058)	EA	1	*	*	*	*	*	*	*	3-49	1A1J1	
M-H		CABLE, RADIO FREQUENCY RG58CU (80058)	FT	REF										
A-F		CABLE ASSEMBLY NUMBER 3 547-1327-002 (13499)	EA	1										1A1W3
P-F	5935-835-0508	CONNECTOR, PLUG, ELECTRICAL MS35168-88E (96906)	EA	REF	*	*	*	*	*	*	*			1A1P6
M-H		CABLE, RADIO FREQUENCY RG58CU (80058)	FT	REF										
X2-H		PLATE, BOTTOM 547-1331-003 (13499)	EA	1										
X2-H		CHASSIS, ELECTRICAL 547-1336-005 (13499)	EA	1										
X2-H		CHASSIS-WELDED 547-1335-005 (13499)	EA	1										
P-F		NUT, CAPTIVE NCN6-2-2-1 (07886)	EA	REF	*	*	*	*	*	*	*			
P-H		FASTENER, ANGLE 504-9478-002 (13499)	EA	10				*	*	*	*			
P-F		NUT, CAPTIVE 543-0435-002 (13499)	EA	REF	*	*	*	*	*	*	*			

SECTION III REPAIR PARTS FOR DIRECT SUPPORT, GENERAL SUPPORT, AND DEPOT MAINTENANCE (CONTINUED)

(1) SNR CODE	(2) FEDERAL STOCK NUMBER	(3) DESCRIPTION  REFERENCE NUMBER & MFR. CODE	(4) UNIT OF MEAS  USABLE ON CODE	(5) QTY INC IN UNIT	(6) 30-DAY DS MAINT ALLOWANCE			(7) 30-DAY GS MAINT ALLOWANCE			(8) 1 YR ALW PER EQUIP CIT/SECY	(9) DEPOT MAINT ALW PER 100 EQUIP	(10) ILLUSTRATIONS	
					(a) 1-20	(b) 21-50	(c) 51-100	(a) 1-20	(b) 21-50	(c) 51-100			(a) FIG NO.	(b) ITEM NO. OR REFERENCE DESIGNATION
					XL-F		BRACKET, MOUNTING 547-1338-004 (13499)	EA	1					
XZ-F		BRACKET, MOUNTING 547-1337-004 (13499)	EA	1										
P-F		NUT, CAPTIVE 543-0435-002 (13499)	EA	REF	*	*	*	*	*	*	*			
XZ-F		RIVET, TUBULAR R4008X1-6CHROMATEDPL (12014)	EA	REF										
P-H	5340-526-3899	CLIP, SPRING TENSION 100-200-4-0 (99378)	EA	REF				*	*	*	*			
P-F	5940-782-8942	TERMINAL, FEEDTHRU FTSM1 (98291)	EA	REF	*	*	*	*	*	*	*			
XZ-F		DIVIDER, CHASSIS 547-1332-003 (13499)	EA	1										
P-H	5905-171-2005	RESISTOR, FIXED, COMPOSITION RC20GF471K (81349)	EA	1				*	*	*	*		3-49	LA1R1
P-F	5905-060-0524	RESISTOR, FIXED, WIRE WOUND RW67W201 (81349)	EA	1	*	*	*	*	*	*	*		3-49	LA1R2
P-F	5910-615-4101	CAPACITOR, FIXED, CERAMIC DIELECTRIC 327-029X5T0102Z (72982)	EA	1	*	*	*	*	*	*	*		3-49	LA1C1
P-F	5910-012-7734	CAPACITOR, FIXED, CERAMIC DIELECTRIC 41C92A5 (01939)	EA	1	*	*	*	*	*	*	*		3-49	LA1C2
M-H		INSULATION SLEEVING, ELECTRICAL TEFTW20B (81851)	FT	REF										
P-F		SCREW, MACHINE P343-0308-000 (77250)	EA	2	*	*	*	*	*	*	*			
P-F	5310-721-3341	WASHER, LOCK AN93688B (88044)	EA	2	*	*	*	*	*	*	*			
P-F		SCREW, MACHINE P343-0306-000 (77250)	EA	3	*	*	*	*	*	*	*			
P-F		WASHER, LOCK 310-0079-000 (79807)	EA	7	*	*	*	*	*	*	*			
P-F	5305-770-2533	SCREW, MACHINE MS51959-13 (96906)	EA	REF	*	*	*	*	*	*	*			
P-F	5310-058-3599	WASHER, LOCK MS35337-57 (96906)	EA	REF	*	*	*	*	*	*	*			
P-F	5310-209-1366	WASHER, LOCK MS35335-58 (96906)	EA	REF	*	*	*	*	*	*	*			
XL-F		POST, MOUNTING, RESISTOR POL5-0552-000 (77250)	EA	REF										
P-F		INSULATOR, WASHER 302-0348-000 (91500)	EA	REF	*	*	*	*	*	*	*			
P-F		WASHER, FLAT 310-0447-000 (79807)	EA	REF	*	*	*	*	*	*	*			
P-F	5305-054-6653	SCREW, MACHINE MS51957-29 (96906)	EA	REF	*	*	*	*	*	*	*			
P-F	5905-894-3488	RESISTOR, FIXED, WIRE WOUND RW30V821 (81349)	EA	1	*	*	*	*	*	*	*			LA1R3

SECTION III REPAIR PARTS FOR DIRECT SUPPORT, GENERAL SUPPORT, AND DEPOT MAINTENANCE (CONTINUED)

(1) SR CODE	(2) FEDERAL STOCK NUMBER	(3) DESCRIPTION  USABLE OR CODE	(4) UNIT OF MEAS	(5) QTY INC IN UNIT	(6) 30-DAY GS MAINT ALLOWANCE			(7) 30-DAY GS MAINT ALLOWANCE			(8) 1 YR ALN PER EQUIP CONTACT	(9) DEPOT MAINT ALN PER 100 EQUIP	(10) ILLUSTRATIONS	
					(a) 1-30	(b) 31-60	(c) 61-100	(a) 1-30	(b) 31-60	(c) 61-100			(a) FIG NO.	(b) ITEM NO. OR REFERENCE DESIGNATION
		GROUP 10 - HANDSET ADAPTER ASSEMBLY C2691/URC												
A-O-R		HANDSET ADAPTER ASSEMBLY C2691/URC 543-6094-000 (13499)	EA	1									3-1	1A9
A-O		PLATE ASSEMBLY 543-6095-000 (13499)	EA	1										
P-F		BUSHING AND NUT UB241MIPL (37942)	EA	REF	*	*	*	*	*	*	*			
P-H		POST, MOUNTING, RESISTOR F015-0558-000 (77250)	EA	REF	*	*	*	*	*	*	*			
P-F	5910-894-0524	RETAINER, CAPACITOR 61023 (14655)	EA	2	*	*	*	*	*	*	*			
M-H		CLAMP, LOOP HP6N (09922)	EA	REF	*	*	*	*	*	*	*			
P-F	5910-583-1256	CAPACITOR, FIXED, ELECTROLYTIC TC2501 (37942)	EA	1	*	*	*	*	*	*	*		3-51	1A9C3
P-F	5910-990-6293	CAPACITOR, FIXED, ELECTROLYTIC 32D2141T (56289)	EA	2	*	*	*	*	*	*	*		3-51	1A9C1
P-F	5910-990-6293	CAPACITOR, FIXED, ELECTROLYTIC 32D2141T (56289)	EA	REF	*	*	*	*	*	*	*		3-51	1A9C2
P-F		GROMMET, RUBBER 905 (75543)	EA	REF	*	*	*	*	*	*	*			
P-F	5930-679-9498	SWITCH 259-0886-000 (13499)	EA	1	*	*	*	*	*	*	*		3-51	1A9S1
P-F	5355-079-9556	KNOB-MODIFIED 547-1380-002 (13499)	EA	REF	*	*	*	*	*	*	*			
XI-F		KNOB 1400XBLK (72512)	EA	REF	*	*	*	*	*	*	*			
P-H	5970-705-9527	INSULATOR, WASHER 302-0347-000 (91500)	EA	REF	*	*	*	*	*	*	*			
P-F	5940-159-1293	TERMINAL, LUG 2104-08-02-2520N (78189)	EA	3	*	*	*	*	*	*	*			
P-F		TERMINAL, STUD 2A1DB12 (92825)	EA	REF	*	*	*	*	*	*	*			
P-F		WASHER, LOCK 310-0079-000 (79807)	EA	REF	*	*	*	*	*	*	*			
P-F	5310-058-2949	WASHER, LOCK MS35337-78 (96906)	EA	REF	*	*	*	*	*	*	*			
P-F	5310-011-1041	WASHER, LOCK MS35338-79 (96906)	EA	REF	*	*	*	*	*	*	*			
P-F		WASHER, FLAT 310-6360-000 (79807)	EA	REF	*	*	*	*	*	*	*			
P-F		NUT, PLAIN, HEXAGON P313-0045-000 (77250)	EA	REF	*	*	*	*	*	*	*			
P-F		NUT, PLAIN, HEXAGON P313-0054-000 (77250)	EA	4	*	*	*	*	*	*	*			
P-F		NUT, PLAIN, HEXAGON P313-0132-000 (77250)	EA	REF	*	*	*	*	*	*	*			
P-F		NUT, PLAIN, HEXAGON P334-4120-000 (77250)	EA	REF	*	*	*	*	*	*	*			
P-F	5305-770-2533	SCREW, MACHINE MS51959-13 (96906)	EA	REF	*	*	*	*	*	*	*			

TM11-5820-555-24P  
SECTION III REPAIR PARTS FOR DIRECT SUPPORT, GENERAL SUPPORT, AND DEPOT MAINTENANCE (CONTINUED)

(1) SMR CODE	(2) FEDERAL STOCK NUMBER	(3) DESCRIPTION  REFERENCE NUMBER & MFR. CODE	(4) UNIT OF MEAS  USABLE ON CODE	(5) QTY INC IN UNIT	(6) 30-DAY DS MAINT ALLOWANCE			(7) 30-DAY GS MAINT ALLOWANCE			(8) 1 YR ALW PER EQUIP CNTGCT	(9) DEPOT MAINT ALW PER 100 EQUIP	(10) ILLUSTRATIONS	
					(a)	(b)	(c)	(a)	(b)	(c)			(a)	(b)
					1-20	21-50	51-100	1-20	21-50	51-100			FIG NO.	ITEM NO. OR REFERENCE DESIGNATION
P-F	5305-763-7822	SCREW, MACHINE MS51999-14 (96906)	EA	REF	*	*	*	*	*	*	*			
P-F	5305-763-6963	SCREW, MACHINE MS51999-28 (96906)	EA	REF	*	*	*	*	*	*	*			
P-F	5305-054-5647	SCREW, MACHINE MS51999-13 (96906)	EA	REF	*	*	*	*	*	*	*			
P-F	5305-054-5648	SCREW, MACHINE MS51999-14 (96906)	EA	REF	*	*	*	*	*	*	*			
A-F		RECTIFIER, ASSEMBLY 553-9516-002 (13499)	EA	1										
P-H	5940-832-8102	TERMINAL BOARD 553-9515-002 (13499)	EA	1				*	*	*	*			
XL-H		BOARD, RECTIFIER 553-9514-002 (13499)	EA	1										
XL-H		TERMINAL, FEEDTHRU CP1044-4-309 (71279)	EA	REF										
P-F	5961-688-6316	SEMICONDUCTOR DEVICE, DIODE 1N1095 (07688)	EA	4	*	*	*	*	*	*	*	3-51	1A9CR1	
P-F	5961-688-6316	SEMICONDUCTOR DEVICE, DIODE 1N1095 (07688)	EA	REF	*	*	*	*	*	*	*	3-51	1A9CR2	
P-F	5961-688-6316	SEMICONDUCTOR DEVICE, DIODE 1N1095 (07688)	EA	REF	*	*	*	*	*	*	*	3-51	1A9CR3	
P-F	5961-688-6316	SEMICONDUCTOR DEVICE, DIODE 1N1095 (07688)	EA	REF	*	*	*	*	*	*	*	3-51	1A9CR4	
P-F	5935-230-1561	CONNECTOR, RECEPTACLE, ELECTRICAL MS3102A1452S (96906)	EA	1	*	*	*	*	*	*	*	3-50	1A9J1	
P-F	5935-853-7596	CONNECTOR, RECEPTACLE, ELECTRICAL UC1094U (80098)	EA	1	*	*	*	*	*	*	*	3-51	1A9J2	
P-F		CONNECTOR, RECEPTACLE, ELECTRICAL MS39179-1094A (96906)	EA	1	*	*	*	*	*	*	*	3-51	1A9J2	
P-F	5310-058-3599	WASHER, LOCK MS39333-57 (96906)	EA	REF	*	*	*	*	*	*	*			
XL-F		BRACKET, TRANSFORMER 546-4035-002 (13499)	EA	1										
P-F	5310-894-0226	NUT, SELF-LOCKING, CLINCH F22NCFMA2-40 (72962)	EA	2	*	*	*	*	*	*	*			
XL-F		BRACKET, ANGLE 546-4034-002 (13499)	EA	1										
P-F		WASHER, LOCK 1720-02CAFPL (78189)	EA	REF	*	*	*	*	*	*	*			
P-H		CORD, NYLON 435-1014-000 (13499)	EA	REF	*	*	*	*	*	*	*			
P-F		WASHER, FLAT 504-0730-000 (13499)	EA	1	*	*	*	*	*	*	*			
P-F		POST, HEXAGON 540-9221-003 (13499)	EA	REF	*	*	*	*	*	*	*			
P-H		POST, MOUNTING, RAISED 541-0163-002 (13499)	EA	REF	*	*	*	*	*	*	*			
P-F	5950-679-9500	TRANSFORMER, AUDIO FREQUENCY CBUN6051 (80694)	EA	1	*	*	*	*	*	*	*	3-51	1A9T2	
P-F	5950-519-8787	TRANSFORMER, POWER 16842 (80089)	EA	1	*	*	*	*	*	*	*	3-51	1A9T1	
P-F	5950-655-0253	REACTOR A8344 (70674)	EA	1	*	*	*	*	*	*	*	3-51	1A9L1	

TM11-5820-55-24P  
SECTION III REPAIR PARTS FOR DIRECT SUPPORT, GENERAL SUPPORT, AND DEPOT MAINTENANCE (CONTINUED)

(1) SHR CODE	(2) FEDERAL STOCK NUMBER	(3) DESCRIPTION  REFERENCE NUMBER & MFR. CODE	(4) UNIT OF MEAS	(5) QTY REQ IN UNIT	(6) 30-DAY DS MAINT ALLOWANCE			(7) 30-DAY GS MAINT ALLOWANCE			(8) 1 YR ALM PER EQUIP CATG	(9) DEPOT MAINT ALM PER 100 EQUIP	(10) ILLUSTRATIONS	
					(a) 1-20	(b) 21-50	(c) 51-100	(a) 1-20	(b) 21-50	(c) 51-100			(a) FIG NO.	(b) ITBM NO. OR REFERENCE DESIGNATION
P-F	5905-185-6966	RESISTOR, FIXED, COMPOSITION RC20GF27LK (81349)	EA	1	*	*	*	*	*	*	*	3-51	1A9R1	
P-H	5905-256-0387	RESISTOR, FIXED, COMPOSITION RC20GF68LK (81349)	EA	1				*	*	*	*	3-51	1A9R2	
P-F	5905-256-0411	RESISTOR, FIXED, COMPOSITION RC42GF16LK (81349)	EA	1	*	*	*	*	*	*	*	3-51	1A9R3	
P-F	5905-253-1229	RESISTOR, FIXED, COMPOSITION RC42GF33LK (81349)	EA	1	*	*	*	*	*	*	*		1A9R4	
P-F	5905-839-4646	RESISTOR, FIXED, WIRE WOUND RW29V2R4 (81349)	EA	1	*	*	*	*	*	*	*	3-51	1A9R5	
P-F	5945-740-2595	RELAY, ARMATURE 40-3587 (04221)	EA	1	*	*	*	*	*	*	*	3-51	1A9K1	
P-F	5935-504-3161	CONNECTOR, RECEPTACLE, ELECTRICAL 26-4402-16S (02660)	EA	1	*	*	*	*	*	*	*	3-51	1A9J3	
X2-F		PLATE-ADAPTER 544-9461-002 (13499)	EA	1										
P-F		NUT, CAPTIVE N0N6-2-2-1 (07886)	EA	REF	*	*	*	*	*	*	*			
X2-F		PLATE-ADAPTER 544-9460-002 (13499)	EA	1										
X2-F		PLATE-FRONT 543-6102-004 (13499)	EA	1										
X2-F		PANEL-RAISED 543-6098-003 (13499)	EA	1										
P-F	5950-833-6629	TRANSFORMER, POWER AL4475 (70674)	EA	1	*	*	*	*	*	*	*	3-51	1A9T3	
P-F	5305-719-5064	SCREW, MACHINE MS1929-30 (96906)	EA	REF	*	*	*	*	*	*	*			
M-H		CABLE-HANDESET 543-6096-000 (13499)	EA	1										
M-H		WIRE, ELECTRICAL MILW16878TYPE22-9 (81349)	FT	REF										
M-H		WIRE, ELECTRICAL MILW16878TYPE22-90 (81349)	FT	RZF										
M-H		WIRE, ELECTRICAL MILW16878TYPE22-91 (81349)	FT	REF										
M-H		WIRE, ELECTRICAL MILW16878TYPE22-92 (81349)	FT	REF										
M-H		WIRE, ELECTRICAL MILW16878TYPE22-93 (81349)	FT	REF										
M-H		WIRE, ELECTRICAL MILW16878TYPE22-95 (81349)	FT	REF										
M-H		WIRE, ELECTRICAL MILW16878TYPE22-96 (81349)	FT	REF										
M-H		WIRE, ELECTRICAL MILW16878TYPE22-902 (81349)	FT	REF										
M-H		WIRE, ELECTRICAL MILW16878TYPE22-903 (81349)	FT	REF										
M-H		WIRE, ELECTRICAL MILW16878TYPE22-905 (81349)	FT	REF										
M-H		WIRE, ELECTRICAL MILW16878TYPE22-906 (81349)	FT	REF										
M-H		WIRE, ELECTRICAL MILW16878TYPE22-912 (81349)	FT	REF										

SECTION III REPAIR PARTS FOR DIRECT SUPPORT, GENERAL SUPPORT, AND DEPOT MAINTENANCE (CONTINUED)

(1) DGR CODE	(2) FEDERAL STOCK NUMBER	(3) DESCRIPTION  REFERENCE NUMBER & MFR. CODE	(4) UNIT OF MEAS	(5) QTY INC IN UNIT	(6) 30-DAY DS MAINT ALLOWANCE			(7) 30-DAY GS MAINT ALLOWANCE			(8) 1 YR ALW PER EQUIP CNTCTY	(9) DEPOT MAINT ALW PER 100 EQUIP	(10) ILLUSTRATIONS	
					(a)	(b)	(c)	(a)	(b)	(c)			(a)	(b)
					1-20	21-50	51-100	1-20	21-50	51-100			FIG NO.	ITEM NO. OR REFERENCE DESIGNATION
M-H		WIRE, ELECTRICAL MILW16878TYPB22-913 (81349)	FT	REF										
M-H		WIRE, ELECTRICAL MILW16878TYPB22-915 (81349)	FT	REF										
M-H		WIRE, ELECTRICAL MILW16878TYPB22-916 (81349)	FT	REF										
M-H		WIRE, ELECTRICAL MILW16878TYPB22-923 (81349)	FT	REF										
M-H		WIRE, ELECTRICAL MILW16878TYPB22-925 (81349)	FT	REF										
M-H		WIRE, ELECTRICAL MILW16878TYPB22-926 (81349)	FT	REF										
M-H		WIRE, ELECTRICAL MILW16878TYPB22-935 (81349)	FT	REF										
M-H		WIRE, ELECTRICAL MILW16878TYPB22-936 (81349)	FT	REF										
M-H		WIRE, ELECTRICAL MILW16878TYPB22-902-3 (81349)	FT	REF										
M-H		CABLE, SPECIAL PURPOSE, ELECTRICAL 1SBUB730NJA10-0 (90484)	FT	2										
M-H		CABLE, SPECIAL PURPOSE, ELECTRICAL 1SBUB730NJA10-9 (90484)	FT	1										
M-H		CABLE, SPECIAL PURPOSE, ELECTRICAL 1SBUB730NJA10-91 (90484)	FT	3										
M-H		CABLE, SPECIAL PURPOSE, ELECTRICAL 1SBUB730NJA10-92 (90484)	FT	3										
M-H		CABLE, SPECIAL PURPOSE, ELECTRICAL 1SBUB730NJA10-93 (90484)	FT	2										
M-H		CABLE, SPECIAL PURPOSE, ELECTRICAL 1SBUB730NJA10-90 (90484)	FT	3										
P-F	5305-054-5646	SCREW, MACHINE MS51957-12 (96906)	EA	REF	*	*	*	*	*	*	*	*		
P-F	5305-054-6652	SCREW, MACHINE MS51957-28 (96906)	EA	REF	*	*	*	*	*	*	*	*		
P-F		TERMINAL, LUG 704-0320-000 (13499)	EA	REF	*	*	*	*	*	*	*	*		
P-H		SCREW, MACHINE P343-0020-000 (77250)	EA	4				*	*	*	*	*		
P-F		SCREW, MACHINE P342-0024-000 (77250)	EA	REF	*	*	*	*	*	*	*	*		
P-H	5940-501-8634	TERMINAL, LUG 4021 (77147)	EA	4				*	*	*	*	*		
P-F		SETScrew 335-0041-000 (08664)	EA	REF	*	*	*	*	*	*	*	*		
P-H		WIRE, ELECTRICAL 44-7023-26-7-93 (06090)	FT	1				*	*	*	*	*		
M-H		INSULATION SLEEVING, ELECTRICAL TEPTW20B (81851)	FT	REF										
P-H		INSULATION SLEEVING, ELECTRICAL MIL13190CIBALSIZB0-0 (81349)	FT	2				*	*	*	*	*		
X2-H		COVER, REAR 543-4400-003 (13499)	EA	REF										
A-H		COVER, RIVETED 543-4403-004 (13499)	EA	REF										

SECTION III REPAIR PARTS FOR DIRECT SUPPORT, GENERAL SUPPORT, AND DEPOT MAINTENANCE (CONTINUED)

(1) SIR CODE	(2) FEDERAL STOCK NUMBER	(3) DESCRIPTION  REFERENCE NUMBER & MFR. CODE	(4) UNIT OF MEAS	(5) QTY INC IN UNIT	(6) 30-DAY DS MAINT ALLOWANCE			(7) 30-DAY GS MAINT ALLOWANCE			(8) 1 VR ALM PER EQUIP CATEGORY	(9) DEPOT MAINT ALM PER 100 EQUIP	(10) ILLUSTRATIONS	
					(a)	(b)	(c)	(a)	(b)	(c)			(a)	(b)
					1-25	21-25	51-100	1-25	21-25	51-100			FIG NO.	ITEM NO. OR REFERENCE DESIGNATION
X2-H		COVER, SPOT-WELDED 343-4403-004 (13499)	EA	REF										
X1-H		CATCH, FLUSH 34600040-250 (83014)	EA	REF										
X1-H		RIVET, TUBULAR 343-1809-002 (13499)	EA	REF										
P-F	5310-011-1041	WASHER, LOCK MS35338-79 (96906)	EA	REF	*	*	*	*	*	*	*	*		
P-F	5305-054-6651	SCREW, MACHINE MS51957-27 (96906)	EA	REF	*	*	*	*	*	*	*	*		
P-F		SCREW, MACHINE P343-0298-000 (77250)	EA	REF	*	*	*	*	*	*	*	*		
P-O		SCREW, TAPPING, THREAD 2X1-6FANHDYTFZCADFL (45722)	EA	REF	*	*	*	*	*	*	*	*		
X2-F		FRAME ASSEMBLY 540-6334-004 (13499)	EA	REF										
P-F		SETScrew 10X32X5-86SPLINEA16SST (08664)	EA	REF	*	*	*	*	*	*	*	*		
P-F	5305-765-4346	SCREW, MACHINE MS51959-35 (96906)	EA	REF	*	*	*	*	*	*	*	*		
P-F	5305-755-4257	SCREW, MACHINE MS51959-43 (96906)	EA	REF	*	*	*	*	*	*	*	*		
P-F	5305-054-6650	SCREW, MACHINE MS51957-26 (96906)	EA	REF	*	*	*	*	*	*	*	*		
P-F	5305-579-3513	SCREW, MACHINE MS35217-55 (96906)	EA	REF	*	*	*	*	*	*	*	*		
P-F	5310-209-1366	WASHER, LOCK MS35335-58 (96906)	EA	REF	*	*	*	*	*	*	*	*		
P-F	5310-054-1831	WASHER, LOCK MS35338-81 (96906)	EA	REF	*	*	*	*	*	*	*	*		
P-F		POST, STANDOFF 561-2189-002 (13499)	EA	REF	*	*	*	*	*	*	*	*		
P-F	5315-791-7836	SCREW, EXTERNALLY RELIEVED BODY 540-6241-002 (13499)	EA	REF	*	*	*	*	*	*	*	*		
X1-F		BLOCK, SPACER 540-6243-002 (13499)	EA	REF										
X2-F		PLATE, HINGE 540-6240-002 (13499)	EA	REF										
X2-F		PLATE, PIVOT 540-6242-002 (13499)	EA	REF										
P-F	5340-634-7444	RING, RETAINING MS16632-1018 (96906)	EA	REF	*	*	*	*	*	*	*	*		
X1-F		BUMPER 561-2190-002 (13499)	EA	REF										
A-F		PLATE, HINGE 540-6258-002 (13499)	EA	REF										
X1-F		PIN, GROOVED 541-3627-002 (13499)	EA	REF										
X1-F		PLATE, HINGE 540-6234-002 (13499)	EA	REF										
X1-F		BLOCK, CENTER 540-6252-003 (13499)	EA	REF										
X2-F		FRAME-STAKED 540-6328-004 (13499)	EA	REF										



SECTION III REPAIR PARTS FOR DIRECT SUPPORT, GENERAL SUPPORT, AND DEPOT MAINTENANCE (CONTINUED)

(1) SR CODE	(2) FEDERAL STOCK NUMBER	(3) DESCRIPTION  REFERENCE NUMBER & MFR. CODE  USABLE ON CGOE	(4) UNIT OF MEAS	(5) QTY INC IN UNIT	(6) 30-DAY DS MAINT ALLOWANCE			(7) 30-DAY GS MAINT ALLOWANCE			(8) 1 YR ALW PER EQUIP CATEGY	(9) DEPOT MAINT ALW PER 100 EQUIP	(10) ILLUSTRATIONS	
					(a)	(b)	(c)	(a)	(b)	(c)			(a)	(b)
					1-20	21-60	61-100	1-20	21-60	61-100			FIG NO.	ITEM NO. OR REFERENCE DESIGNATION
P-H		NUT, PLAIN, HEXAGON 540-6244-002 (13499)	EA	REF				*	*	*	*			
X2-F		FRAME, SPOT-WELDED 540-6316-004 (13499)	EA	REF										
X1-F		CHANNEL, CHASSIS 540-6300-004 (13499)	EA	REF										
X1-F		CHANNEL, CHASSIS 540-6301-004 (13499)	EA	REF										
X2-F		BRACKET, END 540-6283-003 (13499)	EA	REF										
M-D		PLATE, IDENTIFICATION 280-0450-000 (74048)	EA	REF										
M-D		PLATE, IDENTIFICATION 546-7992-002 (13499)	EA	1										
M-D		PLATE, IDENTIFICATION 280-1254-000 (12998)	EA	REF										
		GROUP 11 - UNIT ASSEMBLY - CW and FSK CW-730/URC												
A-O-R		UNIT ASSEMBLY - CW and FSK CW-730/URC 543-8129-000 (13499)	EA	1									3-1	1A6
X2-F		FRAME ASSEMBLY 540-6334-004 (13499)	EA	REF										
P-F		SETScrew 10-32X3-86SPLINE16SST (08664)	EA	REF	*	*	*	*	*	*	*	*		
P-F	5305-765-4346	SCREW, MACHINE MS51959-35 (96906)	EA	REF	*	*	*	*	*	*	*	*		
P-F	5305-765-4257	SCREW, MACHINE MS51959-43 (96906)	EA	REF	*	*	*	*	*	*	*	*		
P-F	5305-054-6650	SCREW, MACHINE MS51957-26 (96906)	EA	REF	*	*	*	*	*	*	*	*		
P-F	5305-579-3513	SCREW, MACHINE MS3217-55 (96906)	EA	REF	*	*	*	*	*	*	*	*		
P-F	5310-209-1366	WASHER, LOCK MS3335-58 (96906)	EA	REF	*	*	*	*	*	*	*	*		
P-F	5310-054-1831	WASHER, LOCK MS3338-81 (96906)	EA	REF	*	*	*	*	*	*	*	*		
P-F		POST 561-2189-002 (13499)	EA	REF	*	*	*	*	*	*	*	*		
P-F	5315-791-7836	SCREW, EXTERNALLY BELIEVED BODY 540-6241-002 (13499)	EA	REF	*	*	*	*	*	*	*	*		
X1-F		BLOCK, SPACER 540-6243-002 (13499)	EA	REF										
X2-F		PLATE, HINGE 540-6240-002 (13499)	EA	REF										
X2-F		PLATE, PIVOT 540-6242-002 (13499)	EA	REF										
P-F	5340-634-7444	RING, RETAINING MS16632-1018 (96906)	EA	REF	*	*	*	*	*	*	*	*		
X1-F		BUMPER 561-2190-002 (13499)	EA	REF										
A-F		PLATE, HINGE 540-6258-002 (13499)	EA	REF										

SECTION III REPAIR PARTS FOR DIRECT SUPPORT, GENERAL SUPPORT, AND DEPOT MAINTENANCE (CONTINUED)

(1) SIR CODE	(2) FEDERAL STOCK NUMBER	(3) DESCRIPTION  REFERENCE NUMBER & MFR. CODE	(4) UNIT OF MEAS	(5) QTY INC IN UNIT	(6) 30-DAY DS MAINT ALLOWANCE			(7) 30-DAY GS MAINT ALLOWANCE			(8) 1 YR ALIP PER EQUIP CATEGORY	(9) DEPOT MAINT ALIP PER 100 EQUIP	(10) ILLUSTRATIONS	
					(a)	(b)	(c)	(a)	(b)	(c)			(*)	(*)
					1-20	21-50	51-100	1-20	21-50	51-100			F15 NO.	ITEM NO. OR REFERENCE DESIGNATION
XI-H	5340-634-7444	PIN, GROOVED 541-3627-002 (13499)	EA	REF										
XI-H		PLATE, HINGE 540-6234-002 (13499)	EA	REF										
XI-H		BLOCK, CENTER 540-6252-003 (13499)	EA	REF										
X2-H		FRAME, STAKED 540-6328-004 (13499)	EA	REF										
P-H		NUT, FLAIN, ROUND 540-6244-002 (13499)	EA	REF				*	*	*	*	*		
X2-H		FRAME, SPOT-WELDED 540-6316-004 (13499)	EA	REF										
X1-H		CHANNEL, CHASSIS 540-6300-004 (13499)	EA	REF										
X1-H		CHANNEL, CHASSIS 540-6301-004 (13499)	EA	REF										
X2-H		BRACKET, EN 540-6283-003 (13499)	EA	REF										
A-H		COVER, RIVETED 543-4403-004 (13499)	EA	REF										
X2-H		COVER, SPOT-WELDED 543-4402-004 (13499)	EA	REF										
X1-H		CATCH, FLUSH H4600040-250 (83014)	EA	REF										
X1-H		RIVET, TUBULAR 543-1809-002 (13499)	EA	REF										
X1-H		PANEL-CONTROL 544-9062-003 (13499)	EA	1										
P-H		POST, SPACING 541-0163-002 (13499)	EA	REF				*	*	*	*	*		
X2-H		PLATE, COVER 544-9064-004 (13499)	EA	1										
X2-H		PLATE, COVER 544-9066-004 (13499)	EA	1										
M-H		CABLE, SIMULATOR 544-9061-000 (13499)	EA	1										
M-H		WIRE, ELECTRICAL MILW16878TYPEB22-90 (81349)	FT	REF										
M-H		WIRE, ELECTRICAL MILW16878TYPEB22-91 (81349)	FT	REF										
M-H		WIRE, ELECTRICAL MILW16878TYPEB22-92 (81349)	FT	REF										
M-H		WIRE, ELECTRICAL MILW16878TYPEB22-93 (81349)	FT	REF										
M-H		WIRE, ELECTRICAL MILW16878TYPEB22-95 (81349)	FT	REF										
M-H		WIRE, ELECTRICAL MILW16878TYPEB22-96 (81349)	FT	REF										
M-H		WIRE, ELECTRICAL MILW16878TYPEB22-902 (81349)	FT	REF										
M-H		WIRE, ELECTRICAL MILW16878TYPEB22-903 (81349)	FT	REF										
M-H		WIRE, ELECTRICAL MILW16878TYPEB22-905 (81349)	FT	REF										

SECTION III REPAIR PARTS FOR DIRECT SUPPORT, GENERAL SUPPORT, AND DEPOT MAINTENANCE (CONTINUED)

(1) SR CODE	(2) FEDERAL STOCK NUMBER	(3) DESCRIPTION  REFERENCE NUMBER & MFR. CODE	(4) UNIT OF MEAS	(5) QTY INC IN UNIT	(6) 30-DAY DS MAINT ALLOWANCE			(7) 30-DAY GS MAINT ALLOWANCE			(8) 1 YR ALW PER EQUIP CNTGCT	(9) DEPOT MAINT ALW PER 100 EQUIP	(10) ILLUSTRATIONS	
					(a) 1-20	(b) 21-50	(c) 51-100	(a) 1-20	(b) 21-50	(c) 51-100			(a) FIG NO.	(b) ITEM NO. OR REFERENCE DESIGNATION
M-H	5340-634-7444	WIRE, ELECTRICAL MILW16878TYPEB22-906 (81349)	FT	REF										
M-H		WIRE, ELECTRICAL MILW16878TYPEB22-912 (81349)	FT	REF										
M-H		WIRE, ELECTRICAL MILW16878TYPEB22-913 (81349)	FT	REF										
M-H		WIRE, ELECTRICAL MILW16878TYPEB22-915 (81349)	FT	REF										
M-H		WIRE, ELECTRICAL MILW16878TYPEB22-916 (81349)	FT	REF										
M-H		WIRE, ELECTRICAL MILW16878TYPEB22-923 (81349)	FT	REF										
M-H		WIRE, ELECTRICAL MILW16878TYPEB22-925 (81349)	FT	REF										
M-H		WIRE, ELECTRICAL MILW16878TYPEB22-926 (81349)	FT	REF										
M-H		WIRE, ELECTRICAL MILW16878TYPEB22-9 (81349)	FT	REF										
M-H		WIRE, ELECTRICAL MILW16878TYPEB22-935 (81349)	FT	REF										
M-H		WIRE, ELECTRICAL MILW16878TYPEB22-936 (81349)	FT	REF										
P-H		WIRE, ELECTRICAL MILW16878TYPEB22-956 (81349)	FT	REF				*	*	*	*	*		
M-H		WIRE, ELECTRICAL MILW16878TYPEB22-902-5 (81349)	FT	REF										
M-H		WIRE, ELECTRICAL MILW16878TYPEB22-902-6 (81349)	FT	REF										
P-H		WIRE, ELECTRICAL MILW16878TYPEB22-9125 (81349)	FT	REF				*	*	*	*	*		
P-H		WIRE, ELECTRICAL MILW16878TYPEB22-9126 (81349)	FT	REF				*	*	*	*	*		
P-H		WIRE, ELECTRICAL MILW16878TYPEB22-9235 (81349)	FT	REF				*	*	*	*	*		
P-H		WIRE, ELECTRICAL MILW16878TYPEB22-9236 (81349)	FT	REF				*	*	*	*	*		
P-H		WIRE, ELECTRICAL MILW16878TYPEB22-9256 (81349)	FT	REF				*	*	*	*	*		
P-H		WIRE, ELECTRICAL MILW16878TYPEB22-9356 (81349)	FT	REF				*	*	*	*	*		
M-H		WIRE, ELECTRICAL MILW16878TYPEB22-912-3 (81349)	FT	REF										
M-H		CABLE, SPECIAL PURPOSE, ELECTRICAL LSBUB730NJA10-90 (90484)	FT	REF										
M-H		CABLE, SPECIAL PURPOSE, ELECTRICAL LSBUB730NJA10-91 (90484)	FT	REF										
M-H		CABLE, SPECIAL PURPOSE, ELECTRICAL LSBUB730NJA10-92 (90484)	FT	REF										
M-H		INSULATION SLEEVING, ELECTRICAL FVAB115-16A (81349)	FT	1										
M-H		WIRE, ELECTRICAL MILW16878TYPEB22-902-3 (81349)	FT	REF										
M-H		CABLE, RADIO FREQUENCY RGL96AU (90058)	FT	REF										

SECTION III REPAIR PARTS FOR DIRECT SUPPORT, GENERAL SUPPORT, AND DEPOT MAINTENANCE (CONTINUED)

(1) SIR CODE	(2) FEDERAL STOCK NUMBER	(3) DESCRIPTION  REFERENCE NUMBER & MFR. CODE	(4) UNIT OF MEAS	(5) QTY REQ IN UNIT	(6) 30-DAY DS MAINT ALLOWANCE			(7) 30-DAY GS MAINT ALLOWANCE			(8) 1 YR ALW PER EQUIP CATG/CY	(9) DEPOT MAINT ALW PER 100 EQUIP	(10) ILLUSTRATIONS	
					(a)	(b)	(c)	(a)	(b)	(c)			(#)	(#)
					1-20	21-50	51-100	1-20	21-50	51-100			FIG NO.	ITEM NO. OR REFERENCE DESIGNATION
XI-H		PLATE, SLIDING 542-3230-002 (13499)	EA	REF										
M-H		WIRE, ELECTRICAL 00702-1322 (70567)	FT	REF										
P-F	5960-860-7710	SHIELD, TUBE 541-6554-003 (13499)	EA	2	*	*	*	*	*	*	*	3-52	1A6E1	
P-F	5960-860-7710	SHIELD, TUBE 541-6554-003 (13499)	EA	REF	*	*	*	*	*	*	*	3-52	1A6E2	
P-H	5960-519-6952	SHIELD, ELECTRON 191-0P1001 (91662)	EA	REF				*	*	*	*			
P-H	5960-552-0236	SHIELD ASSEMBLY 541-8166-002 (13499)	EA	REF				*	*	*	*			
P-H	5960-686-8087	SHIELD, ELECTRON 541-8161-002 (13499)	EA	REF				*	*	*	*			
XI-F		SHIELD 541-81-1-012 (13499)	EA	REF										
P-F	5340-789-2243	SPRING, HELICAL 541-8164-002 (13499)	EA	REF	*	*	*	*	*	*	*			
P-H	5960-649-8665	RETAINER, ELECTRICAL 541-6521-002 (13499)	EA	REF				*	*	*	*			
P-H	6625-678-5478	METER, AUDIO LEVEL MOD525VU (82386)	EA	1				*	*	*	*	3-52	1A6M1	
P-F	5930-108-6980	SWITCH, TOGGLE ST42D (81350)	EA	1	*	*	*	*	*	*	*	3-52	1A6S4	
P-F	5930-655-1523	SWITCH, TOGGLE ST42H (81350)	EA	1	*	*	*	*	*	*	*	3-52	1A6S3	
M-H		WIRE, ELECTRICAL 00702-1320 (70567)	FT	REF										
P-F	5355-079-9556	KNOB, MODIFIED 547-1380-002 (13499)	EA	3	*	*	*	*	*	*	*	3-53	1A601	
P-F	5355-079-9556	KNOB, MODIFIED 547-1380-002 (13499)	EA	REF	*	*	*	*	*	*	*	3-53	1A602	
P-F	5355-079-9556	KNOB, MODIFIED 547-1380-002 (13499)	EA	REF	*	*	*	*	*	*	*	3-53	1A603	
XI-F		KNOB 1400XBLK (72512)	EA	REF										
P-F	5355-668-5311	KNOB 1450WBLK (72512)	EA	1	*	*	*	*	*	*	*	3-53	1A604	
M-H		WIRE, ELECTRICAL MILW16878TYPEB22-9 (81349)	FT	REF										
P-F		BUSHING AND NUT UB241NIPL (37942)	EA	REF	*	*	*	*	*	*	*			
P-F	5905-774-5166	RESISTOR, VARIABLE JA21068 (71450)	EA	1	*	*	*	*	*	*	*	3-52	1A6R19	
P-F	5905-807-4201	RESISTOR, VARIABLE JH21376 (71450)	EA	1	*	*	*	*	*	*	*	3-53	1A6R18	
P-F	6210-023-8555	LAMPHOLDER 50 (72765)	EA	2	*	*	*	*	*	*	*	3-52	1A6XD1	
P-F	6210-023-8555	LAMPHOLDER 50 (72765)	EA	REF	*	*	*	*	*	*	*	3-52	1A6XD2	
P-O	6240-155-8706	LAMP, INCANDESCENT MS15571-2 (96906)	EA	1	*	*	*	*	*	*	*	3-52	1A6DS2	
P-O	6240-155-8714	LAMP, INCANDESCENT MS15571-4 (96906)	EA	1	*	*	*	*	*	*	*	3-52	1A6DS1	

SECTION III REPAIR PARTS FOR DIRECT SUPPORT, GENERAL SUPPORT, AND DEPOT MAINTENANCE (CONTINUED)

(1) S/R CODE	(2) FEDERAL STOCK NUMBER	(3) DESCRIPTION  REFERENCE NUMBER & MFR. CODE	(4) UNIT OF MEAS	(5) QTY INC IN UNIT	(6) 30-DAY DS MAINT ALLOWANCE			(7) 30-DAY GS MAINT ALLOWANCE			(8) 1 YR ALW PER EQUIP CATGRY	(9) DEPOT MAINT ALW PER 100 EQUIP	(10) ILLUSTRATIONS	
					(a) 1-20	(b) 21-50	(c) 51-100	(a) 1-20	(b) 21-50	(c) 51-100			(a) FIG NO.	(b) ITEM NO. OR REFERENCE DESIGNATION
P-O	6210-583-9437	LENS, INDICATOR LIGHT 25-100RED (72756)	EA	1	*	*	*	*	*	*	*	*		1A6DS3
P-F	6210-761-6371	LENS, INDICATOR LIGHT 25-100GRN (72765)	EA	1	*	*	*	*	*	*	*	*		1A6DS4
P-F	5935-729-8618	CONNECTOR, RECEPTACLE 26-4401-24S (02660)	EA	1	*	*	*	*	*	*	*	*	3-53	1A6J1
P-F	5956-678-5479	TRANSFORMER, AUDIO FREQUENCY A10796 (70874)	EA	1	*	*	*	*	*	*	*	*	3-53	1A6T1
P-F	5935-222-9828	SOCKET, ELECTRON 7490-0191 (94991)	EA	2	*	*	*	*	*	*	*	*	3-53	1A6XV1
P-F	5935-222-9828	SOCKET, ELECTRON 7490-0191 (94991)	EA	REF	*	*	*	*	*	*	*	*	3-53	1A6XV2
P-O	5960-636-2218	ELECTRON, TUBE 12AU7 (49671)	EA	1	*	*	*	*	*	*	*	*	3-53	1A6V2
P-O	5960-846-6619	ELECTRON, TUBE 12AT7 (49671)	EA	1	*	*	*	*	*	*	*	*	3-53	1A6V1
P-F	5945-679-9554	RELAY, ARMATURE 11F-93550 (78277)	EA	1	*	*	*	*	*	*	*	*	3-53	1A6K1
P-F	5950-754-6944	COIL, RADIO FREQUENCY 240-0287-000 (13499)	EA	2	*	*	*	*	*	*	*	*	3-53	1A6L1
P-F	5961-978-7660	SEMICONDUCTOR DEVICE, DIODE 1N1489 (07688)	EA	1	*	*	*	*	*	*	*	*	3-53	1A6CR4
P-F	5961-553-6320	SEMICONDUCTOR DEVICE, DIODE 65000 (96214)	EA	1	*	*	*	*	*	*	*	*	3-53	1A6CR1
P-F	5930-678-5337	SWITCH, ROTARY 195982F1 (76854)	EA	1	*	*	*	*	*	*	*	*	3-53	1A6S2
P-F	5930-678-5336	SWITCH, ROTARY 195983F4 (76854)	EA	1	*	*	*	*	*	*	*	*	3-53	1A6S1
P-H	5961-284-6516	SEMICONDUCTOR DEVICE, DIODE 1N198 (07688)	EA	4	*	*	*	*	*	*	*	*	3-53	1A6CR2
P-H	5961-284-6516	SEMICONDUCTOR DEVICE, DIODE 1F198 (07688)	EA	REF	*	*	*	*	*	*	*	*	3-53	1A6CR3
P-H	5961-284-6516	SEMICONDUCTOR DEVICE, DIODE 1N198 (07688)	EA	REF	*	*	*	*	*	*	*	*	3-53	1A6CR5
P-H	5961-284-6516	SEMICONDUCTOR DEVICE, DIODE 1N198 (07698)	EA	REF	*	*	*	*	*	*	*	*	3-53	1A6CR6
P-F	5935-853-7596	CONNECTOR, RECEPTACLE, ELECTRICAL UG10940 (80058)	EA	2	*	*	*	*	*	*	*	*	3-53	1A6J2
P-F	5935-853-7596	CONNECTOR, RECEPTACLE, ELECTRICAL UG10940 (80058)	EA	REF	*	*	*	*	*	*	*	*	3-53	1A6J3
P-F		CONNECTOR, RECEPTACLE, ELECTRICAL ME35179-1094A (96906)	EA	2	*	*	*	*	*	*	*	*	3-53	1A6J2
P-F		CONNECTOR, RECEPTACLE, ELECTRICAL ME35179-1094A (96906)	EA	REF	*	*	*	*	*	*	*	*	3-53	1A6J3
P-F	5910-678-5335	CAPACITOR, FIXED, ELECTROLYTIC D25433 (56289)	EA	4	*	*	*	*	*	*	*	*	3-53	1A6C13
P-F	5910-678-5335	CAPACITOR, FIXED, ELECTROLYTIC D25433 (56289)	EA	REF	*	*	*	*	*	*	*	*	3-53	1A6C14
P-F	5910-678-5335	CAPACITOR, FIXED, ELECTROLYTIC D25433 (56289)	EA	REF	*	*	*	*	*	*	*	*	3-53	1A6C15
P-F	5910-678-5335	CAPACITOR, FIXED, ELECTROLYTIC D25433 (56289)	EA	REF	*	*	*	*	*	*	*	*	3-53	1A6C16
P-F	5910-764-1271	CAPACITOR, FIXED, MICA DIELECTRIC CM07F123003 (81349)	EA	1	*	*	*	*	*	*	*	*	3-53	1A6O9

SECTION III REPAIR PARTS FOR DIRECT SUPPORT, GENERAL SUPPORT, AND DEPOT MAINTENANCE (CONTINUED)

(1) SNR CODE	(2) FEDERAL STOCK NUMBER	(3) DESCRIPTION  REFERENCE NUMBER & MFR. CODE	(4) UNIT OF MEAS	(5) QTY INC IN UNIT	(6) 20-DAY DS MAINT ALLOWANCE			(7) 30-DAY GS MAINT ALLOWANCE			(8) 1 YR ALW PER EQUIP CNTGCT	(9) DEPOT MAINT ALW PER 100 EQUIP	(10) ILLUSTRATIONS	
					(a)	(b)	(c)	(a)	(b)	(c)			(a)	(b)
					1-20	21-50	51-100	1-20	21-50	51-100			FIG NO.	ITEM NO. OR REFERENCE DESIGNATION
P-F	5910-902-2360	CAPACITOR, FIXED, MICA DIELECTRIC CM08F333G03 (81349)	EA	1	*	*	*	*	*	*	*	*		1A6C8
P-F	5910-043-2939	CAPACITOR, FIXED, MICA DIELECTRIC CM07F682G03 (81349)	EA	1	*	*	*	*	*	*	*	*	3-53	1A6C5
P-F	5910-556-1425	CAPACITOR, FIXED, CERAMIC DIELECTRIC 33C2 (01939)	EA	3	*	*	*	*	*	*	*	*	3-53	1A6C1
P-F	5910-556-1425	CAPACITOR, FIXED, CERAMIC DIELECTRIC 33C2 (01939)	EA	REF	*	*	*	*	*	*	*	*	3-53	1A6C10
P-F	5910-556-1425	CAPACITOR, FIXED, CERAMIC DIELECTRIC 33C2 (01939)	EA	REF	*	*	*	*	*	*	*	*	3-53	1A6C11
P-F	5910-678-5334	CAPACITOR, VARIABLE FD52709 (72136)	EA	2	*	*	*	*	*	*	*	*	3-53	1A6C4
P-F	5920-678-5334	CAPACITOR, VARIABLE FD52709 (72136)	EA	REF	*	*	*	*	*	*	*	*	3-53	1A6C6
P-F	5910-812-4062	CAPACITOR, FIXED, PAPER DIELECTRIC 186P10491S15 (56289)	EA	1	*	*	*	*	*	*	*	*	3-53	1A6C3
P-F	5310-644-0486	CAPACITOR, FIXED, PAPER DIELECTRIC 196P10502SP (56289)	EA	1	*	*	*	*	*	*	*	*	3-53	1A6C2
P-F	5910-678-5327	CAPACITOR, FIXED, MICA DIELECTRIC DM20F392G00WV (72136)	EA	2	*	*	*	*	*	*	*	*	3-53	1A6C7
P-F	5905-126-6691	RESISTOR, FIXED, COMPOSITION RC20GF150J (81349)	EA	1	*	*	*	*	*	*	*	*	3-53	1A6R21
P-F	5905-111-4742	RESISTOR, FIXED, COMPOSITION RC20GF391K (81349)	EA	2	*	*	*	*	*	*	*	*	3-53	1A6R4
P-F	5905-111-4742	RESISTOR, FIXED, COMPOSITION RC20GF391K (81349)	EA	REF	*	*	*	*	*	*	*	*	3-53	1A6R15
P-H	5905-257-2631	RESISTOR, FIXED, COMPOSITION RC20GF821K (81349)	EA	1	*	*	*	*	*	*	*	*	3-53	1A6R20
P-H	5905-106-1282	RESISTOR, FIXED, COMPOSITION RC20GF223K (81349)	EA	1	*	*	*	*	*	*	*	*	3-53	1A6R7
P-H	5905-249-4248	RESISTOR, FIXED, COMPOSITION RC20GF333K (81349)	EA	1	*	*	*	*	*	*	*	*	3-53	1A6R3
P-H	5905-190-8882	RESISTOR, FIXED, COMPOSITION RC20GF393K (81349)	EA	1	*	*	*	*	*	*	*	*	3-53	1A6R2
P-F	5905-295-3410	RESISTOR, FIXED, COMPOSITION RC20GF473K (81349)	EA	2	*	*	*	*	*	*	*	*	3-53	1A6R1
P-F	5905-295-3410	RESISTOR, FIXED, COMPOSITION RC20GF473K (81349)	EA	REF	*	*	*	*	*	*	*	*		1A6R8
P-F	5905-254-7097	RESISTOR, FIXED, COMPOSITION RC20GF823K (81349)	EA	2	*	*	*	*	*	*	*	*	3-53	1A6R12
P-F	5905-254-7097	RESISTOR, FIXED, COMPOSITION RC20GF823K (81349)	EA	REF	*	*	*	*	*	*	*	*	3-53	1A6R17
P-H	5905-192-398	RESISTOR, FIXED, COMPOSITION RC20GF104K (81349)	EA	2	*	*	*	*	*	*	*	*	3-53	1A6R6
P-H	5905-192-3987	RESISTOR, FIXED, COMPOSITION RC20GF104K (81349)	EA	REF	*	*	*	*	*	*	*	*	3-53	1A6R9
P-H	5905-192-0662	RESISTOR, FIXED, COMPOSITION RC20GF184K (81349)	EA	1	*	*	*	*	*	*	*	*	3-53	1A6R16
P-H	5905-114-5416	RESISTOR, FIXED, COMPOSITION RC20GF274K (81349)	EA	1	*	*	*	*	*	*	*	*	3-53	1A6R10
P-H	5905-247-8710	RESISTOR, FIXED, COMPOSITION RC32GF220K (81349)	EA	1	*	*	*	*	*	*	*	*	3-53	1A6R13

SECTION III REPAIR PARTS FOR DIRECT SUPPORT, GENERAL SUPPORT, AND DEPOT MAINTENANCE (CONTINUED)

(1) SNR CODE	(2) FEDERAL STOCK NUMBER	(3) DESCRIPTION  REFERENCE NUMBER & MFR. CODE	(4) UNIT OF MEAS  USABLE ON CODE	(5) QTY INC IN UNIT	(6) 30-DAY DS MAINT ALLOWANCE			(7) 30-DAY GS MAINT ALLOWANCE			(8) 1 YR ALM PER EQUIP CMTGCTY	(9) DEPOT MAINT PER 100 EQUIP	(10) ILLUSTRATIONS	
					(a) 1-20	(b) 21-50	(c) 51-100	(a) 1-20	(b) 21-50	(c) 51-100			(a) FIG NO.	(b) ITEM NO. OR REFERENCE DESIGNATION
					P-F	5905-299-2024	RESISTOR, FIXED, COMPOSITION RC32GF183K (81349)	EA	2	*			*	*
P-F	5905-299-2024	RESISTOR, FIXED, COMPOSITION RC32GF183K (81349)	EA	REF	*	*	*	*	*	*	*	3-53	1A6R4	
P-F		SCREW, MACHINE P342-0024-000 (77250)	EA	REF	*	*	*	*	*	*	*			
P-F		SCREW, MACHINE P342-0168-000 (77250)	EA	REF	*	*	*	*	*	*	*			
P-F	5305-054-6652	SCREW, MACHINE MS51957-28 (96906)	EA	REF	*	*	*	*	*	*	*			
P-F	5305-054-5646	SCREW, MACHINE MS51957-12 (96906)	EA	REF	*	*	*	*	*	*	*			
P-F	5305-054-5648	SCREW, MACHINE MS51957-14 (96906)	EA	REF	*	*	*	*	*	*	*			
P-F	5305-054-6654	SCREW, MACHINE MS51957-30 (96906)	EA	REF	*	*	*	*	*	*	*			
P-F		SCREW, MACHINE P343-0284-000 (77250)	EA	REF	*	*	*	*	*	*	*			
P-F		SCREW, MACHINE P343-0330-000 (77250)	EA	REF	*	*	*	*	*	*	*			
P-H	5305-616-2568	SCREW, MACHINE P343-0285-000 (77250)	EA	REF	*	*	*	*	*	*	*			
P-F	5310-275-1347	WASHER, FLAT 310-0046-000 (79807)	EA	REF	*	*	*	*	*	*	*			
P-H		WASHER, LOCK 310-0076-000 (79807)	EA	REF	*	*	*	*	*	*	*			
P-F	5310-209-6069	WASHER, LOCK 310-0077-000 (79807)	EA	REF	*	*	*	*	*	*	*			
P-F	5310-042-9609	WASHER, LOCK MS35338-78 (96906)	EA	REF	*	*	*	*	*	*	*			
P-F	5310-011-1041	WASHER, LOCK MS35338-79 (96906)	EA	REF	*	*	*	*	*	*	*			
P-F		WASHER, LOCK 1712-00-00-4102 (78189)	EA	2	*	*	*	*	*	*	*			
P-F		WASHER, FLAT 310-6360-000 (79807)	EA	REF	*	*	*	*	*	*	*			
P-F	5310-907-0958	WASHER, FLAT 310-0045-000 (79807)	EA	REF	*	*	*	*	*	*	*			
P-H		TERMINAL, LUG 2104-04-01-2520N (78189)	EA	REF	*	*	*	*	*	*	*			
P-F		TERMINAL, LUG 2104-06-02-2520N (78189)	EA	REF	*	*	*	*	*	*	*			
P-F		TERMINAL, LUG 4012HOT TINNED (77146)	EA	REF	*	*	*	*	*	*	*			
P-F		TERMINAL, LUG 304-0320-000 (13499)	EA	REF	*	*	*	*	*	*	*			
P-F		NUT, PLAIN, HEXAGON P313-0053-000 (77250)	EA	REF	*	*	*	*	*	*	*			
P-F		NUT, PLAIN, HEXAGON P334-4120-000 (77250)	EA	REF	*	*	*	*	*	*	*			
P-F		NUT, PLAIN, HEXAGON P313-0132-000 (77250)	EA	REF	*	*	*	*	*	*	*			
P-F		NUT, PLAIN, HEXAGON P313-0152-000 (77250)	EA	2	*	*	*	*	*	*	*			

TM11-5820-555-24P  
SECTION III REPAIR PARTS FOR DIRECT SUPPORT, GENERAL SUPPORT, AND DEPOT MAINTENANCE (CONTINUED)

(1) SAC CODE	(2) FEDERAL STOCK NUMBER	(3) DESCRIPTION  REFERENCE NUMBER & MFR. CODE	(4) UNIT OF MEAS.	(5) QTY INC IN UNIT	(6) 30-DAY DS MAINT ALLOWANCE			(7) 30-DAY GS MAINT ALLOWANCE			(8) I RE ALW PER EQUIP ENTRYS	(9) DEPOT MAINT ALW PER 100 EQUIP	(10) CLASSIFICATIONS	
					(a) 1-20	(b) 21-50	(c) 51-100	(a) 1-20	(b) 21-50	(c) 51-100			(a) FIG NO.	(b) ITEM NO. OR REFERENCE OF SIGNATURE
P-F		NUT, FLAIN, HEXAGON F313-0051-000 (77250)	EA	REF	*	*	*	*	*	*	*			
P-H	5310-857-5548	NUT, SELF-LOCKING, HEXAGON MS21044D04 (96906)	EA	REF	*	*	*	*	*	*	*			
P-F	5325-263-6632	GROMMET, RUBBER MS35499-6 (96906)	EA	REF	*	*	*	*	*	*	*			
P-F		WASHER, LOCK 1720-02CALPL (78189)	EA	REF	*	*	*	*	*	*	*			
P-F		WASHER, LOCK 1722-01CALPL (78189)	EA	REF	*	*	*	*	*	*	*			
P-F		WASHER, LOCK 543-0428-003 (13499)	EA	REF	*	*	*	*	*	*	*			
P-F	5310-167-0857	WASHER, LOCK AN936A516B (88044)	EA	2	*	*	*	*	*	*	*			
M-D		PLATE, IDENTIFICATION 280-1254-060 (12998)	EA	REF	*	*	*	*	*	*	*			
M-D		PLATE, IDENTIFICATION 546-7990-002 (13499)	EA	1	*	*	*	*	*	*	*			
P-F	5325-174-5317	GROMMET, RUBBER MS35499-4 (96906)	EA	REF	*	*	*	*	*	*	*			
M-H		CLAMP, LOOP HP7N (09922)	EA	REF	*	*	*	*	*	*	*			
P-F		TERMINAL, STUD 2B10B12 (92825)	EA	REF	*	*	*	*	*	*	*			
A-F		BOARD ASSEMBLY 545-3125-002 (13499)	EA	1	*	*	*	*	*	*	*			
P-H		WASHER, FLAT 310-0055-000 (79807)	EA	REF	*	*	*	*	*	*	*			
P-F		SCREW, MACHINE F343-0333-000 (77250)	EA	REF	*	*	*	*	*	*	*			
M-H		WIRE, ELECTRICAL 00702-1322 (70567)	FT	REF	*	*	*	*	*	*	*			
P-F	5950-754-6944	COIL, RADIO FREQUENCY 240-0287-000 (13499)	EA	REF	*	*	*	*	*	*	*	3-53	1A6L2	
P-F	5905-993-2261	RESISTOR, FIXED, FILM RM65D4642F (81349)	EA	1	*	*	*	*	*	*	*	3-53	1A6R29	
P-H	5905-195-6758	RESISTOR, FIXED, COMPOSITION RC20GF273X (81349)	EA	1	*	*	*	*	*	*	*	3-53	1A6R28	
P-F	5910-806-3412	CAPACITOR, FIXED, MICA DIELECTRIC CM06F202003 (81349)	EA	1	*	*	*	*	*	*	*	3-53	1A6C20	
P-F	5910-717-0167	CAPACITOR, FIXED, MICA DIELECTRIC CM06F471003 (81349)	EA	2	*	*	*	*	*	*	*	3-53	1A6C19	
P-F	5910-717-0167	CAPACITOR, FIXED, MICA DIELECTRIC CM06F471003 (81349)	EA	REF	*	*	*	*	*	*	*	3-53	1A6C22	
P-F	5910-045-5432	CAPACITOR, FIXED, MICA DIELECTRIC CM06F681003 (81349)	EA	1	*	*	*	*	*	*	*	3-53	1A6C21	
P-F	5910-823-1068	CAPACITOR, FIXED, CERAMIC DIELECTRIC CG62AW472M (81349)	EA	1	*	*	*	*	*	*	*	3-53	1A6C17	
P-F	5910-556-1425	CAPACITOR, FIXED, CERAMIC DIELECTRIC 33C2 (01939)	EA	1	*	*	*	*	*	*	*	3-53	1A6C18	
P-H	5840-938-8301	BOARD, TERMINAL 545-3133-002 (13499)	EA	1	*	*	*	*	*	*	*	3-53	1A6TB1	
XL-H		TERMINAL, STUD 2034B (71279)	EA	11	*	*	*	*	*	*	*			



SECTION III REPAIR PARTS FOR DIRECT SUPPORT, GENERAL SUPPORT, AND DEPOT MAINTENANCE (CONTINUED)

(1) S/R CODE	(2) FEDERAL STOCK NUMBER	(3) DESCRIPTION  REFERENCE NUMBER & MFR. CODE	(4) UNIT OF MEAS	(5) QTY INC IN UNIT	(6) 30-DAY DS MAINT ALLOWANCE			(7) 30-DAY GS MAINT ALLOWANCE			(8) 1 YR ALW PER EQUIP CATG	(9) DEPOT MAINT ALW PER 100 EQUIP	(10) ILLUSTRATIONS	
					(a) 1-20	(b) 21-50	(c) 51-100	(a) 1-20	(b) 21-50	(c) 51-100			(a) FIG NO.	(b) ITEM NO. OR REFERENCE DESIGNATION
					USABLE ON CODE									
XI-H		BOARD, TERMINAL 545-3132-002 (13499)	EA	1										
M-H		INSULATION SLEEVING, ELECTRICAL M1L13190CLBA1SIZE20-0 (81349)	FT	3										
P-F	5310-754-3071	POST, HEXAGON 540-9053-003 (13499)	EA	2	*	*	*	*	*	*	*			
A-H		OSCILLATOR ASSEMBLY 545-3124-000 (13499)	EA	1									1A6A1	
X2-H		COVER, MODIFIED 545-3126-002 (13499)	EA	1										
X1-H		COIL, SHIELD 141-2061-000 (13499)	EA	1										
P-F		SCREW, MACHINE P343-0286-000 (77250)	EA	REF	*	*	*	*	*	*	*			
P-F		WASHER, LOCK 310-0396-000 (79807)	EA	REF	*	*	*	*	*	*	*			
X2-F		BRACKET 545-3128-002 (13499)	EA	1										
P-F		NUT, CAPTIVE N0N4-1-2 (07886)	EA	REF	*	*	*	*	*	*	*			
X1-F		FASTENER, ANGLE 504-7698-002 (13499)	EA	REF										
X2-F		BRACKET 545-3127-002 (13499)	EA	1										
X2-F		BLOCK-TAP 545-3129-002 (13499)	EA	2										
P-H		SCREW, MACHINE P342-0142-000 (77250)	EA	8				*	*	*	*			
P-H	5910-028-1308	CAPACITOR, VARIABLE 36812-18 (80583)	EA	1				*	*	*	*	3-54	1A6A1C11	
P-F		SCREW, MACHINE P330-2290-000 (77250)	EA	REF	*	*	*	*	*	*	*			
A-H		BOARD 545-3140-000 (13499)	EA	1										
M-H		INSULATION SLEEVING, ELECTRICAL TEFTW24-0 (81851)	FT	1										
M-H		INSULATION SLEEVING, ELECTRICAL TEFTW24-6 (81851)	FT	REF										
M-H		INSULATION SLEEVING, ELECTRICAL TEFTW24-5 (81851)	FT	REF										
M-H		INSULATION SLEEVING, ELECTRICAL TEFTW24-4 (81851)	FT	REF										
P-H	5820-938-8299	BOARD, FLARED 545-3139-004 (13499)	EA	1				*	*	*	*			
P-H		TERMINAL, STUD 542-4085-002 (13499)	EA	REF				*	*	*	*			
X1-H		EYELET, METALLIC 542-0810-003 (13499)	EA	REF										
X2-H		EYELET, METALLIC 542-0811-003 (13499)	EA	REF										
X1-H		BOARD, CIRCUIT 545-3138-004 (13499)	EA	1										
P-F	5910-755-9291	CAPACITOR, FIXED, ELECTROLYTIC 150D10520035A2 (56289)	EA	1	*	*	*	*	*	*	*	3-54	1A6A1C4	

SECTION III REPAIR PARTS FOR DIRECT SUPPORT, GENERAL SUPPORT, AND DEPOT MAINTENANCE (CONTINUED)

(1) SNR CODE	(2) FEDERAL STOCK NUMBER	(3) DESCRIPTION  REFERENCE NUMBER & MFR. CODE	(4) UNIT OF MEAS	(5) QTY INC IN UNIT	(6) 30-DAY DS MAINT ALLOWANCE			(7) 30-DAY GS MAINT ALLOWANCE			(8) 1 YR ALW PER EQUIP CMTY	(9) DEPOT MAINT ALW PER 100 EQUIP	(10) ILLUSTRATIONS	
					(a)	(b)	(c)	(a)	(b)	(c)			(a)	(b)
					1-20	21-50	51-100	1-20	21-50	51-100			FIG NO.	ITEM NO. OR REFERENCE DESIGNATION
P-F	5961-989-6106	TRANSISTOR 2N274 (07638)	EA	1	*	*	*	*	*	*	*	3-54	1A6A1Q1	
P-H	5961-284-6516	SEMICONDUCTOR DEVICE, DIODE 1M198 (07688)	EA	1	*	*	*	*	*	*	*	3-54	1A6A1Q1	
P-F	5905-811-0673	RESISTOR, FIXED, COMPOSITION R007G682K (81349)	EA	2	*	*	*	*	*	*	*	3-54	1A6A1R2	
P-F	5905-811-0673	RESISTOR, FIXED, COMPOSITION R007G682K (81349)	EA	REF	*	*	*	*	*	*	*	3-54	1A6A1R6	
P-H	5905-816-8554	RESISTOR, FIXED, COMPOSITION R007G103K (81349)	EA	1	*	*	*	*	*	*	*	3-54	1A6A1R4	
P-F	5905-686-2529	RESISTOR, FIXED, COMPOSITION R007G123K (81349)	EA	1	*	*	*	*	*	*	*	3-54	1A6A1R5	
P-F	5905-116-8555	RESISTOR, FIXED, COMPOSITION R007G153K (81349)	EA	1	*	*	*	*	*	*	*	3-54	1A6A1R7	
P-F	5905-116-8556	RESISTOR, FIXED, COMPOSITION R007G223K (81349)	EA	1	*	*	*	*	*	*	*	3-54	1A6A1R3	
P-H	5905-106-9345	RESISTOR, FIXED, COMPOSITION RC20G683J (81349)	EA	1	*	*	*	*	*	*	*	3-54	1A6A1R1	
P-F		CAPACITOR, FIXED, MICA DIELECTRIC CM05E600J3 (81349)	EA	1	*	*	*	*	*	*	*	3-54	1A6A1C8	
P-F	5910-851-0687	CAPACITOR, FIXED, MICA DIELECTRIC DM20F2220500WV (72136)	EA	2	*	*	*	*	*	*	*	3-54	1A6A1C6	
P-F	5910-851-0687	CAPACITOR, FIXED, MICA DIELECTRIC DM20F2220500WV (72136)	EA	REF	*	*	*	*	*	*	*	3-54	1A6A1C9	
P-F	5910-678-5327	CAPACITOR, FIXED, MICA DIELECTRIC DM20F3920500WV (72136)	EA	REF	*	*	*	*	*	*	*	3-54	1A6A1C7	
P-F	5910-823-1068	CAPACITOR, FIXED, CERAMIC DIELECTRIC CK62AN472M (81346)	EA	1	*	*	*	*	*	*	*	3-54	1A6A1C5	
P-F	5950-678-5331	COIL 545-3143-003 (13499)	EA	1	*	*	*	*	*	*	*	3-54	1A6A1L1	
XI-F		COIL, MOUND 545-3142-003 (13499)	EA	1	*	*	*	*	*	*	*			
XI-F		FORM, COIL 150-0123-000 (20254)	EA	1	*	*	*	*	*	*	*			
M-H		WIRE, ELECTRICAL 422-0065-000 (13499)	FT	REF	*	*	*	*	*	*	*			
XI-H		PIN 545-6011-002 (13499)	EA	3	*	*	*	*	*	*	*			
P-F	5305-054-5648	SCREW, MACHINE MS51957-14 (96906)	EA	REF	*	*	*	*	*	*	*			
P-F		WASHER, FLAT 310-0131-000 (05411)	EA	8	*	*	*	*	*	*	*			
M-H		WIRE, ELECTRICAL MILW16878TYPE22-90 (81349)	FT	REF	*	*	*	*	*	*	*			
M-H		WIRE, ELECTRICAL MILW16878TYPE22-92 (81349)	FT	REF	*	*	*	*	*	*	*			
M-H		WIRE, ELECTRICAL MILW16878TYPE22-93 (81349)	FT	REF	*	*	*	*	*	*	*			
X2-F		PLATE-BASE 545-3131-002 (13499)	EA	1	*	*	*	*	*	*	*			
P-F	5310-918-7213	NUT, CAPTIVE NGN-2-2-1 (07886)	EA	REF	*	*	*	*	*	*	*			
X2-F		PLATE-BASE 545-3130-002 (13499)	EA	1	*	*	*	*	*	*	*			

TM11-5820-555-24P  
SECTION III REPAIR PARTS FOR DIRECT SUPPORT, GENERAL SUPPORT, AND DEPOT MAINTENANCE (CONTINUED)

(1) SIR CODE	(2) FEDERAL STOCK NUMBER	(3) DESCRIPTION  REFERENCE NUMBER & MFR. CODE	(4) UNIT OF MEAS	(5) QTY INC IN UNIT	(6) 30-DAY DS MAINT ALLOWANCE			(7) 30-DAY GS MAINT ALLOWANCE			(8) 1 YR ALN PER EQUIP CNTGTY	(9) DEPOT MAINT ALN PER 100 EQUIP	(10) ILLUSTRATIONS	
					(a) 1-20	(b) 21-50	(c) 51-100	(a) 1-20	(b) 21-50	(c) 51-100			(a) FIG NO.	(b) ITEM NO. OR REFERENCE DESIGNATION
CL-F		GROMMET, RUBBER MS35489-1 (96906)	EA	REF										
P-F	5910-615-4101	CAPACITOR, FIXED, CERAMIC DIELECTRIC 327-029X5T01022 (72982)	EA	3	*	*	*	*	*	*	*		3-54	1A66121
P-F	5910-615-4101	CAPACITOR, FIXED, CERAMIC DIELECTRIC 327-029X5T01022 (72982)	EA	REF	*	*	*	*	*	*	*		3-54	1A66122
P-F	5910-615-4101	CAPACITOR, FIXED, CERAMIC DIELECTRIC 327-029X5T01022 (72982)	EA	REF	*	*	*	*	*	*	*		3-54	1A66123
P-F		NUT, PLAIN, HEXAGON P313-0149-000 (77250)	EA	REF	*	*	*	*	*	*	*			
P-F	5310-958-7252	WASHER, LOCK AN936A416B (88044)	EA	REF	*	*	*	*	*	*	*			
P-F		TERMINAL, LUG 2109-14-00-2520N (78189)	EA	1	*	*	*	*	*	*	*			
XL-F		CORE, ADJUSTABLE, TUNING 51-2560 (92054)	EA	1										
P-F	5910-851-0687	CAPACITOR, SELECT FROM CAPACITOR, FIXED, CERAMIC DIELECTRIC DA931-001 (71590)	EA	1	*	*	*	*	*	*	*		3-54	1A661C10
P-F	5910-044-4958	- OR - CAPACITOR, FIXED, CERAMIC DIELECTRIC DA931-004 (71590)	EA	1	*	*	*	*	*	*	*		3-54	1A661C10
P-F	5910-669-3356	- OR - CAPACITOR, FIXED, CERAMIC DIELECTRIC DA931-003 (71590)	EA	1	*	*	*	*	*	*	*		3-54	1A661C10
P-F	5910-051-1997	- OR - CAPACITOR, FIXED, CERAMIC DIELECTRIC DA932-001 (71590)	EA	1	*	*	*	*	*	*	*		3-54	1A661C10
P-F	5910-044-4959	- OR - CAPACITOR, FIXED, CERAMIC DIELECTRIC DA933-010 (71590)	EA	1	*	*	*	*	*	*	*		3-54	1A661C10
P-F	5910-244-1622	- OR - CAPACITOR, FIXED, CERAMIC DIELECTRIC DA933-011 (71590)	EA	1	*	*	*	*	*	*	*		3-54	1A661C10
P-F	5910-919-3952	- OR - CAPACITOR, FIXED, CERAMIC DIELECTRIC DA933-012 (71590)	EA	1	*	*	*	*	*	*	*		3-54	1A661C10
P-F	5910-668-7488	- OR - CAPACITOR, FIXED, CERAMIC DIELECTRIC DA933-013 (71590)	EA	1	*	*	*	*	*	*	*		3-54	1A661C10
P-F	5910-051-1998	- OR - CAPACITOR, FIXED, CERAMIC DIELECTRIC DA933-027 (71590)	EA	1	*	*	*	*	*	*	*		3-54	1A661C10
M-H		WIRE, ELECTRICAL MILW16876TYPE22-9 (81349)	FT	REF										
M-H		WIRE, ELECTRICAL 00702-1320 (70567)	FT	REF										
M-H		CABLE, RADIO FREQUENCY R.196AU (80058)	FT	REF										
M-D		PLATE, IDENTIFICATION 280-0430-000 (74048)	EA	REF										
P-F		SCREW, TAPPING, THREAD 2X1-6PANHDTYPECADPL (45722)	EA	REF	*	*	*	*	*	*	*			
M-H		INSULATION SLEEVING, ELECTRICAL MIL-I-3190CLBAISIZE20-0 (81349)	FT	REF										
M-H		INSULATION SLEEVING, ELECTRICAL MIL-I-3190CLBAISIZE17-0 (81349)	FT	1										
P-H		INSULATION SLEEVING, ELECTRICAL MIL-I-3190CLBAISIZE0 (81349)	FT	REF										
P-F		SCREW, MACHINE P343-0298-000 (77250)	EA	REF	*	*	*	*	*	*	*			
P-F		RESISTOR, FIXED, FILM RM65DE250F (81349)	EA	1	*	*	*	*	*	*	*		3-53	1A66R22

SECTION II REPAIR PARTS FOR DIRECT SUPPORT, GENERAL SUPPORT, AND DEPOT MAINTENANCE (CONTINUED)

(1) SIR CODE	(2) FEDERAL STOCK NUMBER	(3) DESCRIPTION  REFERENCE NUMBER & MFR. CODE	(4) USABLE OR CODE	(5) UNIT OF MEAS	(6) QTY INC IN UNIT	(7) 30-DAY GS MAINT ALLOWANCE			(8) 30-DAY GS MAINT ALLOWANCE			(9) 1 YR ALIN PER EQUIP CMTY	(10) DEPOT MAINT ALIN PER 100 EQUIP	(11) ILLUSTRATIONS	
						(a)	(b)	(c)	(a)	(b)	(c)			(a)	(b)
						1-20	21-50	51-100	1-20	21-50	51-100			FIG NO.	ITEM NO. OR REFERENCE DESIGNATION
P-F	5905-068-0066	RESISTOR, FIXED, FILM RM65D6491F (81349)		EA	1	*	*	*	*	*	*	*	*	3-53	1A6R23
P-F	5905-079-6536	RESISTOR, FIXED, FILM RM65D1332F (81349)		EA	1	*	*	*	*	*	*	*	*	3-53	1A6R24
P-F	5905-245-0023	RESISTOR, FIXED, COMPOSITION RC20GF682K (81349)		EA	1	*	*	*	*	*	*	*	*	3-53	1A6R27
P-F	5305-141-0591	RESISTOR, FIXED, COMPOSITION RC20GF103K (81349)		EA	1	*	*	*	*	*	*	*	*	3-53	1A6R26
P-H	5905-110-0993	RESISTOR, FIXED, COMPOSITION RC20GF123K (81349)		EA	1	*	*	*	*	*	*	*	*	3-53	1A6R25
P-F	5905-299-2014	RESISTOR, FIXED, COMPOSITION RC32GF473K (81349)		EA	1	*	*	*	*	*	*	*	*	3-53	1A6R11
P-O		KIT, MOUNTING 541-1477-002 (13499)		EA	REF	*	*	*	*	*	*	*	*		
M-H		BAG, COTTON 024-0100-000 (13499)		EA	REF	*	*	*	*	*	*	*	*		
P-O	5310-054-1830	WASHER, LOCK MS35338-80 (96906)		EA	REF	*	*	*	*	*	*	*	*		
P-O		WASHER, FLAT 310-0167-000 (79807)		EA	REF	*	*	*	*	*	*	*	*		
P-O		WASHER, LOCK 310-0286-000 (13499)		EA	REF	*	*	*	*	*	*	*	*		
P-O	5305-579-3507	SCREW, MACHINE MS35216-40 (96906)		EA	REF	*	*	*	*	*	*	*	*		
P-O		SCREW, MACHINE P343-0247-000 (77250)		EA	REF	*	*	*	*	*	*	*	*		
P-F	5305-054-6653	SCREW, MACHINE MS51957-29 (96906)		EA	REF	*	*	*	*	*	*	*	*		
P-F	5905-126-1701	RESISTOR, FIXED, COMPOSITION RC32GF680K (81349)		EA	1	*	*	*	*	*	*	*	*	3-53	1A6R30
P-F	5910-279-4122	CAPACITOR, FIXED, PAPER DIELECTRIC 185P47403T15 (56289)		EA	1	*	*	*	*	*	*	*	*	3-53	1A6C27
P-F		SETSCREW 335-0041-000 (08664)		EA	REF	*	*	*	*	*	*	*	*		
P-F		SCREW, MACHINE P342-0151-000 (77250)		EA	REF	*	*	*	*	*	*	*	*		
A-F-R		GROUP 12 - RACK, ELECTRICAL EQUIPMENT MT-2251/U		EA	1									3-1	1A13
XI-F		RACK, ELECTRICAL EQUIPMENT MT-2251/U 544-9010-000 (13499)		EA	1										1A13MP1
XI-F		CHANNEL-RIGHT 544-9014-004 (13499)		EA	1										1A13MP2
XI-F		CHANNEL-LEFT 544-9015-004 (13499)		EA	1										1A13MP8
XI-F		BASE-RACK 544-9007-004 (13499)		EA	1										1A13MP3
XI-F		ANGLE-REAR TOP 544-9013-003 (13499)		EA	1										1A13H1
P-F	5310-275-0586	WASHER, LOCK MS35338-84 (96906)		EA	1	*	*	*	*	*	*	*	*		1A13H4
P-F		SCREW, MACHINE 325-0124-000 (17264)		EA	1	*	*	*	*	*	*	*	*		1A13H4

SECTION II REPAIR PARTS FOR DIRECT SUPPORT, GENERAL SUPPORT, AND DEPOT MAINTENANCE (CONTINUED)

(1) SIR CODE	(2) FEDERAL STOCK NUMBER	(3) DESCRIPTION  REFERENCE NUMBER & MFR. CODE	(4) UNIT OF MEAS	(5) QTY INC IN UNIT	(6) 30-DAY DS MAINT ALLOWANCE			(7) 30-DAY GS MAINT ALLOWANCE			(8) 1 YR ALW PER EQUIP CRNGCY	(9) DEPOT MAINT ALW PER 100 EQUIP	(10) ILLUSTRATIONS	
					(a) 1-20	(b) 21-50	(c) 51-100	(a) 1-20	(b) 21-50	(c) 51-100			(a) FIG NO.	(b) ITEM NO. OR REFERENCE DESIGNATION
XI-F	5305-071-1316	PLATE-ANGLE 544-9012-002 (13499)	EA	1									1A13M7	
XI-F		ANGLE-BASE 545-3048-002 (13499)	EA	1									1A13M5	
P-F		SCREW, MACHINE MS1957-80 (96906)	EA	1	*	*	*	*	*	*	*	*		1A13H5
P-F		WASHER, LOCK MS3138-82 (96906)	EA	1	*	*	*	*	*	*	*	*		1A13H2
P-F		NUT, PLAIN, HEXAGON P313-0082-000 (77250)	EA	1	*	*	*	*	*	*	*	*		1A13H7
P-F		WASHER, FLAT 310-0050-000 (79807)	EA	1	*	*	*	*	*	*	*	*		1A13H3
XI-F		ANGLE-TOP 545-3049-002 (13499)	EA	1										1A13M6
P-F	5305-719-5021	SCREW, MACHINE MS1959-81 (96906)	EA	1	*	*	*	*	*	*	*		1A13H6	
P-H		5305-054-5636	SCREW, MACHINE MS1957-2 (96906)	EA	REF				*	*	*	*		
A-F-R	KIT-AIR DUCT 544-9001-000 (13499)		EA	1										1A13A1
XI-F	5310-906-9833	DUCT-AIR 546-0333-003 (13499)	EA	1										
XI-F		DUCT-AIR, FRONT 544-9002-004 (13499)	EA	1										1A13AMP1
P-F		NUT, SELF-LOCKING, CLINCH FL2NCPM1-02 (72962)	EA	3	*	*	*	*	*	*	*	*		
XI-F		DUCT-AIR 545-6156-003 (13499)	EA	1										
XI-F		NUT, BLIND, RIVET A6875 (25472)	EA	4										
XI-F		DUCT-AIR, REAR 544-9003-004 (13499)	EA	1										1A13AMP2
P-F		NUT, SELF-LOCKING, CLINCH FL2NCPM1-02 (72962)	EA	REF	*	*	*	*	*	*	*	*		
P-F	5310-906-9833	SCREW, TAPPING, THREAD PR6X16-5 (45722)	EA	1	*	*	*	*	*	*	*	*		1A13AH1
XI-F		SUPPORT-DUCT 541-8211-002 (13499)	EA	2										1A13AMP3
XI-F		SUPPORT-DUCT 541-8211-002 (13499)	EA	REF										1A13AMP4
P-F		5305-579-3513	SCREW, MACHINE MS3217-55 (96906)	EA	1	*	*	*	*	*	*	*		1A13AH2
P-F			WASHER, FLAT 310-0049-000 (79807)	EA	1	*	*	*	*	*	*	*	*	
XI-F		COVER, AIR-DUCT 541-8253-003 (13499)	EA	1										1A13AMP5
XI-F		TRANSITION-DUCT 542-8732-004 (13499)	EA	1										
A-F	DUCT ASSEMBLY 542-3007-003 (13499)	EA	2											
XI-F	DUCT, AIR-SHORT 542-3233-002 (13499)	EA	1										1A13AMP7	
M-H	WIRE, STEEL 542-3237-002 (13499)	EA	2										1A13AH7	

SECTION II REPAIR PARTS FOR DIRECT SUPPORT, GENERAL SUPPORT, AND DEPOT MAINTENANCE (CONTINUED)

(1) SIR CODE	(2) FEDERAL STOCK NUMBER	(3) DESCRIPTION  REFERENCE NUMBER & MFR. CODE	(4) UNIT OF MEAS	(5) QTY REQ. IN UNIT	(6) 30-DAY DS MAINT ALLOWANCE			(7) 30-DAY GC MAINT ALLOWANCE			(8) 1 VR ALM PER EQUIP CENCY	(9) DEPOT MAINT ALM PER 100 EQUIP	(10) ILLUSTRATIONS	
					(a) 1-20	(b) 21-50	(c) 51-100	(a) 1-20	(b) 21-50	(c) 51-100			(a) FIG NO.	(b) ITEM NO. OR REFERENCE DEFINITION
XI-H		ACTUATOR-SHORT 542-3020-002 (13499)	EA	1									1A13A1MFB	
XI-H		ACTUATOR-SHORT 542-3018-002 (13499)	EA	1										
XI-H		DISC, AIR DUCT 542-3235-002 (13499)	EA	8										
XI-H		SPRING, HELICAL 542-3022-002 (13499)	EA	2									1A13A1H8	
A-F		DUCT ASSEMBLY 542-3008-003 (13499)	EA	6										
A-F		DUCT, AIR-LONG 542-3234-002 (13499)	EA	1									1A13A1M9	
M-H		WIRE STEEL 542-3237-002 (13499)	EA	REF									1A13A1H7	
XI-H		ACTUATOR-LONG 542-3021-002 (13499)	EA	1									1A13A1M10	
XI-H		ACTUATOR-LONG 542-3019-002 (13499)	EA	1										
XI-H		DISC, AIR-DUCT 542-3235-002 (13499)	EA	REF										
XI-H		SPRING, HELICAL 542-3022-002 (13499)	EA	REF									1A13A1H8	
A-H		KIT-CABLE 544-9019-000 (13499)	EA	1									1A13A2	
P-H		CORD, NYLON 435-1014-000 (13499)	FT	REF				*	*	*	*	*		
P-H	5995-889-0673	CABLE ASSEMBLY, RADIO FREQUENCY 543-3440-002 (13499)	EA	5				*	*	*	*	*	1A13A2W2	
P-H	5995-889-0673	CABLE ASSEMBLY, RADIO FREQUENCY 543-3440-002 (13499)	EA	REF				*	*	*	*	*	1A13A2W5	
P-H	5995-889-0673	CABLE ASSEMBLY, RADIO FREQUENCY 543-3440-002 (13499)	EA	REF				*	*	*	*	*	1A13A2W6	
P-H	5995-889-0673	CABLE ASSEMBLY, RADIO FREQUENCY 543-3440-002 (13499)	EA	REF				*	*	*	*	*	1A13A2W7	
P-H	5995-889-0673	CABLE ASSEMBLY, RADIO FREQUENCY 543-3440-002 (13499)	EA	REF				*	*	*	*	*	1A13A2W8	
P-F	5935-835-0508	CONNECTOR, PLUG, ELECTRICAL MS35168-88E (96906)	EA	10	*	*	*	*	*	*	*	*	1A13A2W2P1	
P-F	5935-835-0508	CONNECTOR, PLUG, ELECTRICAL MS35168-88E (96906)	EA	REF	*	*	*	*	*	*	*	*	1A13A2W2P2	
P-F	5935-835-0508	CONNECTOR, PLUG, ELECTRICAL MS35168-88E (96906)	EA	REF	*	*	*	*	*	*	*	*	1A13A2W5P1	
P-F	5935-835-0503	CONNECTOR, PLUG, ELECTRICAL MS35168-88E (96906)	EA	REF	*	*	*	*	*	*	*	*	1A13A2W5P2	
P-F	5935-835-0508	CONNECTOR, PLUG, ELECTRICAL MS35168-88E (96906)	EA	REF	*	*	*	*	*	*	*	*	1A13A2W6P1	
P-F	5935-835-0508	CONNECTOR, PLUG, ELECTRICAL MS35168-88E (96906)	EA	REF	*	*	*	*	*	*	*	*	1A13A2W6P2	
P-F	5935-835-0508	CONNECTOR, PLUG, ELECTRICAL MS35168-88E (96906)	EA	REF	*	*	*	*	*	*	*	*	1A13A2W7P1	
P-F	5935-835-0508	CONNECTOR, PLUG, ELECTRICAL MS35168-88E (96906)	EA	REF	*	*	*	*	*	*	*	*	1A13A2W7P2	

SECTION II REPAIR PARTS FOR DIRECT SUPPORT, GENERAL SUPPORT, AND DEPOT MAINTENANCE (CONTINUED)

(1) SIR CODE	(2) FEDERAL STOCK NUMBER	(3) DESCRIPTION  REFERENCE NUMBER & MFR. CODE	(4) UNIT OF MEAS	(5) QTY INC IN UNIT	(6) 30-DAY DS MAINT ALLOWANCE			(7) 30-DAY GS MAINT ALLOWANCE			(8) 1 YR MAINT EQUIP COST/100 EQUIP	(9) DEPOT MAINT EQUIP COST/100 EQUIP	(10) ILLUSTRATIONS  (a) FIG NO.	(11) ITEM NO. OR REFERENCE DESIGNATION
					(a)	(b)	(c)	(a)	(b)	(c)				
					1-20	21-50	51-100	1-20	21-50	51-100				
P-F	5935-835-0508	CONNECTOR, PLUG, ELECTRICAL MS35168-88E (96906)	EA	REF	*	*	*	*	*	*	*	*	1A13A2W8P1	
P-F	5935-835-0508	CONNECTOR, PLUG, ELECTRICAL MS35168-88E (96906)	EA	REF	*	*	*	*	*	*	*	*	1A13A2W8P2	
M-H		CABLE, RADIO FREQUENCY U0909BU (80058)	FT	REF										
P-H	5995-935-0342	CABLE ASSEMBLY, RADIO FREQUENCY 543-3441-002 (13499)	EA	1				*	*	*	*	*	1A13A2W9	
P-H	5935-581-1811	CONNECTOR, PLUG, ELECTRICAL U0932AU (80058)	EA	2				*	*	*	*	*	1A13A2W9P1	
P-H	5935-581-1811	CONNECTOR, PLUG, ELECTRICAL U0932AU (80058)	EA	REF				*	*	*	*	*	1A13A2W9P2	
M-H		CABLE, RADIO FREQUENCY RG59BU (80058)	FT	7										
P-H	5995-823-3068	CABLE ASSEMBLY, RADIO FREQUENCY 543-3442-002 (13499)	EA	1				*	*	*	*	*	1A13A2W4	
P-F	5935-835-0506	CONNECTOR, PLUG, ELECTRICAL MS35168-88E (96906)	EA	2	*	*	*	*	*	*	*	*	1A13A2W4P1	
P-F	5935-835-0508	CONNECTOR, PLUG, ELECTRICAL MS35168-88E (96906)	EA	REF	*	*	*	*	*	*	*	*	1A13A2W4P2	
M-H		CABLE, RADIO FREQUENCY RG58CU (80058)	FT	REF										
P-H	5995-935-0340	CABLE ASSEMBLY 544-9021-002 (13499)	EA	1				*	*	*	*	*	1A13A2W1	
P-H	5935-722-3190	CONNECTOR, PLUG, ELECTRICAL U0994AU (80058)	EA	2				*	*	*	*	*	1A13A2W1P1	
P-H	5935-722-3190	CONNECTOR, PLUG, ELECTRICAL U0994AU (80058)	EA	REF				*	*	*	*	*	1A13A2W1P2	
P-H	5935-283-2910	CONNECTOR, PLUG, ELECTRICAL RF0235 (94375)	EA	2				*	*	*	*	*	1A13A2W1P1	
P-H	5935-283-2910	CONNECTOR, PLUG, ELECTRICAL RF0235 (94375)	EA	REF				*	*	*	*	*	1A13A2W1P2	
M-H		CABLE, RADIO FREQUENCY RG213U (80058)	FT	6										
A-H		CABLE ASSEMBLY, SPECIAL PURPOSE 544-2577-002 (13499)	EA	1									1A13A2W26	
P-H	5935-543-8640	CONNECTOR, PLUG, ELECTRICAL 26-4501-8P (02660)	EA	1				*	*	*	*	*	1A13A2W26P1	
M-H		TERMINAL BOARD 543-2000-003 (13499)	EA	1									1A13A2W26TBS	
M-H		INSERT 543-1998-003 (13499)	EA	16										
P-H		TERMINAL, LUG 543-1995-003 (13499)	EA	16				*	*	*	*	*		
M-H		CABLE, SPECIAL PURPOSE, ELECTRICAL 30183 (04796)	FT	128										
M-H		INSULATION SLEEVING, ELECTRICAL MIL13190CLBA1SIZE1-0 (81349)	FT	1										

SECTION II REPAIR PARTS FOR DIRECT SUPPORT, GENERAL SUPPORT, AND DEPOT MAINTENANCE (CONTINUED)

(1) SIB CODE	(2) FEDERAL STOCK NUMBER	(3) DESCRIPTION  REFERENCE NUMBER & REF. CODE	(4) UNIT OF MEAS	(5) QTY REQD PER UNIT	(6) 30-DAY GS MAINT ALLOWANCE			(7) 30-DAY GS MAINT ALLOWANCE			(8) 30-DAY GS MAINT EQUIP CONTR	(9) DEPOT MAINT EQUIP CONTR	(10) F26 NO.	(11) ILLUSTRATION ITEM NO. OR REFERENCE DESCRIPTION
					(a) 1-20	(b) 21-50	(c) 51-100	(a) 1-20	(b) 21-50	(c) 51-100				
P-H	5935-296-8771	CONNECTOR, PLUG, ELECTRICAL 26-4501-16D (02660)	EA	3				*	*	*	*	*	1A13A2W13P1	
P-H	5935-296-8771	CONNECTOR, PLUG, ELECTRICAL 26-4501-16D (02660)	EA	REF				*	*	*	*	*	1A13A2W17P1	
P-H	5935-296-8771	CONNECTOR, PLUG, ELECTRICAL 26-4501-16D (02660)	EA	REF				*	*	*	*	*	1A13A2W19P1	
M-H		TERMINAL BOARD 543-2000-003 (13499)	EA	3									1A13A2W11TBA	
M-H		TERMINAL BOARD 543-2000-003 (13499)	EA	REF									1A13A2W17TBC	
M-H		TERMINAL BOARD 543-2000-003 (13499)	EA	REF									1A13A2W19TBJ	
M-H		INSERT 543-1998-003 (13499)	EA	REF										
P-H		TERMINAL, LUG 543-1999-003 (13499)	EA	REF				*	*	*	*	*		
M-H		CABLE, SPECIAL PURPOSE, ELECTRICAL 30183 (04796)	FT	REF										
A-H		CABLE ASSEMBLY NUMBER 2 544-2579-002 (13499)	EA	2									1A13A2W13	
A-H		CABLE ASSEMBLY NUMBER 2 544-2579-002 (13499)	EA	REF									1A13A2W20	
P-H	5935-655-3355	CONNECTOR, PLUG, ELECTRICAL 26-4503-16P (02660)	EA	2				*	*	*	*	*	1A13A2W13P1	
P-H	5935-655-3355	CONNECTOR, PLUG, ELECTRICAL 26-4503-16P (02660)	EA	REF				*	*	*	*	*	1A13A2W20P1	
M-H		TERMINAL BOARD 542-2000-003 (13499)	EA	2									1A13A2W13TBC	
M-H		TERMINAL BOARD 542-2000-003 (13499)	EA	REF									1A13A2W20TBA	
M-H		INSERT 543-1998-003 (13499)	EA	REF										
P-H		TERMINAL, LUG 543-1999-003 (13499)	EA	REF				*	*	*	*	*		
M-H		CABLE, SPECIAL PURPOSE, ELECTRICAL 30183 (04796)	FT	REF										
P-H		CABLE ASSEMBLY NUMBER 3 544-2580-002 (13499)	EA	2				*	*	*	*	*	1A13A2W12	
P-H		CABLE ASSEMBLY NUMBER 3 544-2580-002 (13499)	EA	REF				*	*	*	*	*	1A13A2W15	
P-H	5935-655-0724	CONNECTOR, PLUG, ELECTRICAL 26-4505-16P (02660)	EA	2				*	*	*	*	*	1A13A2W12P1	
P-H	5935-65-0724	CONNECTOR, PLUG, ELECTRICAL 26-4505-16P (02660)	EA	REF				*	*	*	*	*	1A13A2W15P1	
M-H		TERMINAL BOARD 543-2000-003 (13499)	EA	2									1A13A2W12TBA	
M-H		TERMINAL BOARD 543-2000-003 (13499)	EA	REF									1A13A2W15TBA	
M-H		INSERT 543-1998-003 (13499)	EA	REF										
P-H		TERMINAL, LUG 543-1999-003 (13499)	EA	REF				*	*	*	*	*		
M-H		CABLE, SPECIAL PURPOSE, ELECTRICAL 30183 (04796)	FT	REF										



TM11-5820-555-24P

SECTION II REPAIR PARTS FOR DIRECT SUPPORT, GENERAL SUPPORT, AND DEPOT MAINTENANCE (CONTINUED)

(1) SIR CODE	(2) FEDERAL STOCK NUMBER	(3) DESCRIPTION  REFERENCE NUMBER & MFR. CODE	(4) UNIT OF MEAS	(5) QTY INC IN UNIT	(6) 30-DAY DS MAINT ALLOWANCE			(7) 30-DAY GS MAINT ALLOWANCE			(8) 1 YR ALW PER EQUIP CNTGTY	(9) DEPOT MAINT ALW PER 100 EQUIP	(10) ILLUSTRATIONS	
					(a) 1-20	(b) 21-50	(c) 51-100	(a) 1-20	(b) 21-50	(c) 51-100			(a) FIG NO.	(b) ITEM NO. OR REFERENCE DESIGNATION
P-H		CABLE ASSEMBLY NUMBER 4 544-2581-002 (13499)	EA	4				*	*	*	*	*	1A13A2W16	
P-H		CABLE ASSEMBLY NUMBER 4 544-2581-002 (13499)	EA	REF				*	*	*	*	*	1A13A2W18	
P-H		CABLE ASSEMBLY NUMBER 4 544-2581-002 (13499)	EA	REF				*	*	*	*	*	1A13A2W22	
P-H		CABLE ASSEMBLY NUMBER 4 544-2581-002 (13499)	EA	REF				*	*	*	*	*	1A13A2W24	
P-H	5935-296-8792	CONNECTOR, PLUG, ELECTRICAL 26-4502-16P (02660)	EA	4				*	*	*	*	*	1A13A2W16P1	
P-H	5935-298-8792	CONNECTOR, PLUG, ELECTRICAL 26-4502-16P (02660)	EA	REF				*	*	*	*	*	1A13A2W18P1	
P-H	5935-296-8792	CONNECTOR, PLUG, ELECTRICAL 26-4502-16P (02660)	EA	REF				*	*	*	*	*	1A13A2W22P1	
P-H	5935-296-8792	CONNECTOR, PLUG, ELECTRICAL 26-4502-16P (02660)	EA	REF				*	*	*	*	*	1A13A2W24P1	
M-H		TERMINAL BOARD 30183 (04796)	EA	4									1A13A2W16TBF	
M-H		TERMINAL BOARD 30183 (04796)	EA	REF									1A13A2W18TBH	
M-H		TERMINAL BOARD 30183 (04796)	EA	REF									1A13A2W22TBM	
M-H		TERMINAL BOARD 30183 (04796)	EA	REF									1A13A2W22TBP	
M-H		INSERT 543-1998-003 (13499)	EA	REF										
P-H		TERMINAL, LUG 543-1999-003 (13499)	EA	REF				*	*	*	*	*		
M-H		CABLE, SPECIAL PURPOSE, ELECTRICAL 30183 (04796)	FT	REF										
P-H		CABLE ASSEMBLY NUMBER 5 544-2582-002 (13499)	EA	2				*	*	*	*	*	1A13A2W21	
P-H		CABLE ASSEMBLY NUMBER 5 544-2582-002 (13499)	EA	REF				*	*	*	*	*	1A13A2W23	
P-H	5935-655-0725	CONNECTOR, PLUG, ELECTRICAL 26-4504-16P (02660)	EA	2				*	*	*	*	*	1A13A2W21P1	
P-H	5935-655-0725	CONNECTOR, PLUG, ELECTRICAL 26-4504-16P (02660)	EA	REF				*	*	*	*	*	1A13A2W23P1	
M-H		TERMINAL BOARD 543-2000-003 (13499)	EA	2									1A13A2W21TBL	
M-H		TERMINAL BOARD 543-2000-003 (13499)	EA	REF									1A13A2W23TBN	
M-H		INSERT 543-1998-003 (13499)	EA	REF										
P-H		TERMINAL, LUG 543-1999-003 (13499)	EA	REF				*	*	*	*	*		
M-H		CABLE, SPECIAL PURPOSE, ELECTRICAL 30183 (04796)	FT	REF										
M-H		CABLE ASSEMBLY 544-2583-003 (13499)	EA	1									1A13A2W25	
F-H	5940-246-3853	TERMINAL, LUG 32442 (00779)	EA	REF				*	*	*	*	*		

SECTION II REPAIR PARTS FOR DIRECT SUPPORT, GENERAL SUPPORT, AND DEPOT MAINTENANCE (CONTINUED)

(1) SNR CODE	(2) FEDERAL STOCK NUMBER	(3) DESCRIPTION  REFERENCE NUMBER & MFR. CODE	(4) UNIT OF MEAS	(5) QTY INC IN UNIT	(6) 30-DAY DS MAINT ALLOWANCE			(7) 30-DAY GS MAINT ALLOWANCE			(8) 3 YR ALW PER EQUIP CATEGORY	(9) DEPOT MAINT ALW PER 100 EQUIP	(10) ILLUSTRATIONS	
					(a)	(b)	(c)	(a)	(b)	(c)			(a)	(b)
					1-20	21-50	51-100	1-20	21-50	51-100			1-20	21-50
M-H		TERMINAL, LUG MS25036-2 (96906)	EA	REF										
M-H		CABLE, SPECIAL PURPOSE, ELECTRICAL 30183 (04796)	FT	REF										
M-H		TERMINAL BOARD 543-2000-003 (13499)	EA	1									1A1 3A2W25TBH	
M-H		INSERT 543-1998-003 (13499)	EA	REF										
P-H		TERMINAL, LUG 543-1999-003 (13499)	EA	REF				*	*	*	*	*		
M-H		CABLE ASSEMBLY NUMBER 6 544-9020-002 (13499)	EA	1									1A1 3A2W14	
P-H	5935-502-7716	CONNECTOR, PLUG, ELECTRICAL 26-4501-24P (02660)	EA	1				*	*	*	*	*	1A1 3A2W14P1	
M-H		TERMINAL BOARD 543-2000-003 (13499)	EA	1									1A1 3A2W14TBD	
M-H		INSERT 543-1998-003 (13499)	EA	REF										
P-H		TERMINAL, LUG 543-1999-003 (13499)	EA	REF				*	*	*	*	*		
M-H		CABLE, SPECIAL PURPOSE, ELECTRICAL 30183 (04796)	FT	REF										
P-H	5935-683-7892	ADAPTER, CABLE UG274BU (80058)	EA	1				*	*	*	*	*	1A1 3A2CP1	
P-F	5340-598-0496	CLAMP, LOOP HP8N (09922)	EA	1	*	*	*	*	*	*	*	*	1A1 3A2H1	
P-F	5305-054-6654	SCREW, MACHINE MS51957-30 (96906)	EA	1	*	*	*	*	*	*	*	*	1A1 3A2H2	
X1-F		BRACKET, CABLE 543-3435-002 (13499)	EA	6										
X1-F		POST-1 INCH 541-6076-002 (13499)	EA	1									1A1 3A2H3	
P-H	5305-764-0076	SCREW, MACHINE MS51959-51 (96906)	EA	1				*	*	*	*	*	1A1 3A2H4	
M-H		INSULATION SLEEVING, ELECTRICAL 3003TEMPLEX-105CLR3-8IN (75037)	FT	1									1A1 3A2H7	
A-H		COAXIAL ASSEMBLY 545-9120-002 (13499)	EA	2									1A1 3A2W10	
A-H		COAXIAL ASSEMBLY 545-9120-002 (13499)	EA	REF									1A1 3A2W27	
P-F	5935-835-0508	CONNECTOR, PLUG, ELECTRICAL MS35168-88E (96906)	EA	4	*	*	*	*	*	*	*	*	1A1 3A2W10P1	
P-F	5935-835-0508	CONNECTOR, PLUG, ELECTRICAL MS35168-88E (96906)	EA	REF	*	*	*	*	*	*	*	*	1A1 3A2W10P2	
P-F	5935-835-0508	CONNECTOR, PLUG, ELECTRICAL MS35168-88E (96906)	EA	REF	*	*	*	*	*	*	*	*	1A1 3A2W27P1	
P-F	5935-835-0508	CONNECTOR, PLUG, ELECTRICAL MS35168-88E (96906)	EA	REF	*	*	*	*	*	*	*	*	1A1 3A2W27P2	
M-H		CABLE, RADIO FREQUENCY RG58CU (30058)	FT	REF										
M-H		CABLE, RADIO FREQUENCY 546-3425-000 (13499)	FT	1									1A1 3A2W3	

TM11-5820-555-24P  
SECTION II REPAIR PARTS FOR DIRECT SUPPORT, GENERAL SUPPORT, AND DEPOT MAINTENANCE (CONTINUED)

(1) SR CODE	(2) FEDERAL STOCK NUMBER	(3) DESCRIPTION  USABLE ON CODE	(4) UNIT OF MEAS	(5) QTY INC IN UNIT	(6) 30-DAY DS MAINT ALLOWANCE			(7) 30-DAY GS MAINT ALLOWANCE			(8) 1 YR PLW PER EQUIP CATEGY	(9) DEPOT MAINT PLW PER 100 EQUIP	(10) ILLUSTRATIONS	
					(a)	(b)	(c)	(a)	(b)	(c)			(a) FIG NO.	(b) ITEM NO. OR REFERENCE DESIGNATION
					1-20	21-50	51-100	1-20	21-50	51-100				
P-F	5935-835-0508	CONNECTOR, PLUG, ELECTRICAL MS35168-88E (96906)	EA	2	*	*	*	*	*	*	*	*		1A13A2W3P1
P-F	5935-835-0508	CONNECTOR, PLUG, ELECTRICAL MS35168-88E (96906)	EA	REF	*	*	*	*	*	*	*	*		1A13A2W3P2
M-H		CABLE, RADIO FREQUENCY RC58CU (80058)	FT	REF										
P-H		MOUNTING KIT-SHIP EGARD 545-3226-000 (13499)	EA	1				*	*	*	*	*		
P-O	5920-686-0025	FUSE, CARTRIDGE F60C500V20A (81349)	EA	2	*	*	*	*	*	*	*	*		1A13F1
P-O	5920-686-0025	FUSE, CARTRIDGE F60C500V20A (81349)	EA	REF	*	*	*	*	*	*	*	*		1A13F2
A-O-F		HANDESET H-169/U H169U (80058)	EA	1									3-1	1A13A3
P-O		HANDESET CASE 65B762A (54715)	EA	1	*	*	*	*	*	*	*	*		
P-H	5965-683-2075	RECEIVER CAP 65A763A (54715)	EA	1				*	*	*	*	*		
XI-H		MOUTHPIECE 90A787 (54715)	EA	1										
P-H	5965-624-4141	RETAINING RING 65A764A (54715)	EA	1				*	*	*	*	*		
P-H	5965-624-4134	MICROPHONE AMPLIFIER 90A782 (54715)	EA	1				*	*	*	*	*		1A13A3MCI
P-H	5965-678-5305	RECEIVER 90A781 (54715)	EA	1				*	*	*	*	*	3-55	1A13A3HT1
P-H	5930-078-2755	SWITCH 90A789 (54715)	EA	1				*	*	*	*	*	3-55	1A13A3S1
A-H		CORD PROTECTOR 90A784 (54715)	EA	1										
P-H		SPRING 44A118 (54715)	EA	1				*	*	*	*	*		
P-H		GLAND NUT 31A947 (54715)	EA	1				*	*	*	*	*		
XI-H		PACKING WASHER 42A704 (54715)	EA	1										
P-H		CABLE-PLUG ASSEMBLY 95A718 (54715)	EA	1				*	*	*	*	*		
P-H		GASKET 36A720 (54715)	EA	1				*	*	*	*	*		
P-H		CLAMP, LOOP C3044-4-35 (78553)	EA	3				*	*	*	*	*		
P-H	5340-828-4138	CLAMP, LOOP C3044-6-35 (78553)	EA	2				*	*	*	*	*		
P-H	5340-828-4139	CLAMP, LOOP C3044-8-35 (78553)	EA	2				*	*	*	*	*		
M-H		BAG, COTTON O24-0100-000 (13499)	EA	REF										
M-D		PLATE, IDENTIFICATION 544-2628-002 (13499)	EA	1										
P-H	5305-054-5636	SCREW, MACHINE MS51957-2 (96906)	EA	REF				*	*	*	*	*		
P-F	5905-195-5524	RESISTOR, FIXED, COMPOSITION RC42GF182K (81349)	EA	1	*	*	*	*	*	*	*	*		1A13R1

SECTION II REPAIR PARTS FOR DIRECT SUPPORT, GENERAL SUPPORT, AND DEPOT MAINTENANCE (CONTINUED)

(1) SR CODE	(2) FEDERAL STOCK NUMBER	(3) DESCRIPTION  REFERENCE NUMBER & MFR. CODE	(4) UNIT OF MEAS	(5) QTY INC. IN UNIT	(6) 30-DAY GS MAINT ALLOWANCE			(7) 30-DAY GS MAINT ALLOWANCE			(8) 1 YR M PER EQUIP CENCY	(9) DEPOT M PER 100 EQUIP	(10) ILLUSTRATIONS	
					(a) 1-20	(b) 21-40	(c) 41-100	(a) 1-20	(b) 21-40	(c) 41-100			(a) FIG NO.	(b) ITEM NO. OR REFERENCE DESIGNATION
P-H	5940-271-7986	TERMINAL, LUG 35109 (00779)	EA	3				*	*	*	*			
M-H		WIRE, ELECTRICAL MILM16878TYPED12-9 (81349)	FT	1										
M-H		WIRE, ELECTRICAL 543-0314-002 (13499)	FT	REF										
M-H		WIRE, ELECTRICAL MILM16878TYPED12-92 (81349)	FT	1										
M-H		WIRE, ELECTRICAL 00702-1320 (70567)	FT	REF										
M-H		INSULATION SLEEVING, ELECTRICAL TEPTW198 (81851)	FT	REF										
M-H		WIRE, ELECTRICAL 00702-1318 (70567)	FT	REF										
M-H		INSULATION SLEEVING, ELECTRICAL TEPTW17B (81851)	FT	REF										
M-H		BAND, MARKER, CABLE 152-3769-000 (04740)	EA	1										
M-H		BAND, MARKER, CABLE 152-3770-000 (04740)	EA	1										
M-H		BAND, MARKER, CABLE 152-3771-000 (04740)	EA	1										
M-H		BAND, MARKER, CABLE 152-3772-000 (04740)	EA	1										
M-H		BAND, MARKER, CABLE 152-3773-000 (04740)	EA	1										
M-H		BAND, MARKER, CABLE 152-3774-000 (04740)	EA	1										
M-H		BAND, MARKER, CABLE 152-3775-000 (04740)	EA	1										
M-H		BAND, MARKER, CABLE 152-3776-000 (04740)	EA	1										
M-H		BAND, MARKER, CABLE 152-3777-000 (04740)	EA	1										
M-H		BAND, MARKER, CABLE 152-3778-000 (04740)	EA	1										
M-H		BAND, MARKER, CABLE 152-3779-000 (04740)	EA	1										
M-H		BAND, MARKER, CABLE 152-3780-000 (04740)	EA	1										
M-H		BAND, MARKER, CABLE 152-3781-000 (04740)	EA	1										
M-H		BAND, MARKER, CABLE 152-3782-000 (04740)	EA	1										
M-H		BAND, MARKER, CABLE 152-3783-000 (04740)	EA	1										
M-H		BAND, MARKER, CABLE 152-3784-000 (04740)	EA	1										
M-H		BAND, MARKER, CABLE 152-3785-000 (04740)	EA	1										
M-H		BAND, MARKER, CABLE 152-3786-000 (04740)	EA	1										
M-H		TAG 025-0122-000 (13499)	EA	1										

SECTION III REPAIR PARTS FOR DIRECT SUPPORT, GENERAL SUPPORT, AND DEPOT MAINTENANCE (CONTINUED)

(1) SNR CODE	(2) FEDERAL STOCK NUMBER	(3) DESCRIPTION  REFERENCE NUMBER & MFR. CODE	(4) USABLE ON CODE	(5) UNIT OF MEAS	(6) QTY INC IN UNIT	(6) 30-DAY GS MAINT ALLOWANCE			(7) 30-DAY GS MAINT ALLOWANCE			(8) 1 YR ALM PER EQUIP CNTQCY	(9) DEPOT MAINT ALM PER 100 EQUIP	(10) ILLUSTRATIONS		
						(a)	(b)	(c)	(a)	(b)	(c)			(a)	(b)	
						1-20	21-50	51-100	1-20	21-50	51-100			1-20	21-50	51-100
M-H		TAG, WIRING 545-6168-002 (13499)		EA	1											
M-H		TAG 025-0095-000 (13499)		EA	1											
		GROUP 13 - DUMMY LOAD ELECTRICAL 172J-1														
A-O-R		DUMMY LOAD, ELECTRICAL 172J-1 522-1741-000 (13499)		EA	1											1A14
P-H		INSULATOR, STANDOFF NS9W0104 (81350)		EA	4				*	*	*	*	*	3-56		1A14E1
P-H		INSULATOR, STANDOFF NS9W0104 (81350)		EA	REF				*	*	*	*	*	3-56		1A14E2
P-H		INSULATOR, STANDOFF NS9W0104 (81350)		EA	REF				*	*	*	*	*	3-56		1A14E3
P-H		INSULATOR, STANDOFF NS9W0104 (81350)		EA	REF				*	*	*	*	*	3-56		1A14E4
M-D		PLATE, IDENTIFICATION 280-1254-000 (12998)		EA	REF											
P-F		WASHER, NONMETALLIC 302-0026-000 (05284)		EA	REF	*	*	*	*	*	*	*	*			
P-H		WASHER, LOCK 310-0076-000 (79807)		EA	REF				*	*	*	*	*			
P-F	5310-209-6069	WASHER, LOCK 310-0077-000 (79807)		EA	REF	*	*	*	*	*	*	*	*			
P-F		NUT, PLAIN, HEXAGON P313-0140-000 (77250)		EA	REF	*	*	*	*	*	*	*	*			
P-F		SCREW, TAPPING, THREAD 2X1-8PANHDTYPECADP1 (45722)		EA	REF	*	*	*	*	*	*	*	*			
P-F	5305-054-6652	SCREW, MACHINE MS51937-28 (96906)		EA	REF	*	*	*	*	*	*	*	*			
P-H		SCREW, MACHINE P343-0287-000 (77250)		EA	REF				*	*	*	*	*			
P-F		SCREW, MACHINE P343-0328-000 (77250)		EA	REF	*	*	*	*	*	*	*	*			
P-H		POST, SPACING 540-9448-003 (13499)		EA	2				*	*	*	*	*			
A-H		CABLE ASSEMBLY, RADIO FREQUENCY 545-5928-000 (13499)		EA	1											1A14W1
P-H	5935-577-8776	CONNECTOR, PLUG, ELECTRICAL UG21EU (80058)		EA	2				*	*	*	*	*			1A14P1
P-H	5935-577-8776	CONNECTOR, PLUG, ELECTRICAL UG21EU (80058)		EA	REF				*	*	*	*	*			1A14P2
M-H		CABLE, RADIO FREQUENCY RG213U (80058)		FT	REF											
M-H		MARKER, IDENTIFICATION 139-3002-010 (13499)		EA	1											
A-H		CONTACT 545-5932-002 (13499)		EA	1									3-56		1A14H2
XI-H		RING, STRAP 545-5929-002 (13499)		EA	2											
XI-H		YOKE, CONTACT 545-5931-002 (13499)		EA	1											

SECTION II REPAIR PARTS FOR DIRECT SUPPORT, GENERAL SUPPORT, AND DEPOT MAINTENANCE (CONTINUED)

(1) DSR CODE	(2) FEDERAL STOCK NUMBER	(3) DESCRIPTION  REFERENCE NUMBER & REF. CODE	(4) UNIT OF MEAS	(5) QTY INC IN UNIT	(6) 30-DAY DS MAINT ALLOWANCE			(7) 30-DAY GS MAINT ALLOWANCE			(8) 1 YR AVL PER EQUIP CMTY	(9) DEPOT MAINT ALM PER 100 EQUIP	(10) ILLUSTRATIONS				
					(a)	(b)	(c)	(a)	(b)	(c)			(a)	(b)	(c)	(a)	(b)
XI-H		MOUNT, STRAP 545-5930-002 (13499)	EA	1									3-56	1A14R1			
X2-H		COVER, CHASSIS 545-5933-003 (13499)	EA	1									3-56	1A14R2			
X2-H		CHASSIS, PRESSED 545-5935-004 (13499)	EA	1									3-56	1A14R1			
X2-H		CHASSIS, WELDED 545-5934-004 (13499)	EA	1													
P-H	5310-274-3179	NUT, SELF-LOCKING, CLINCH 68NCL-62 (72962)	EA	10				*	*	*	*	*					
P-H		STRAP, CONTACT 545-5947-002 (13499)	EA	1				*	*	*	*	*					
XI-H		RING, STRAP 545-5929-002 (13499)	EA	REF													
XI-H		MOUNT-STRAP 545-5930-002 (13499)	EA	REF													
P-F	5905-073-2240	RESISTOR, FIXED, SILICON, BORON 891SP50P10PCTM5PCT (10646)	EA	1	*	*	*	*	*	*	*	*	3-56	1A14R1			
P-F		SCREW, MACHINE P343-0329-000 (77250)	EA	REF	*	*	*	*	*	*	*	*					
P-H		SCREW, MACHINE P343-0332-000 (77250)	EA	2				*	*	*	*	*					
P-F	5935-974-5418	CONNECTOR, RECEPTACLE, ELECTRICAL U058AU (80058)	EA	1	*	*	*	*	*	*	*	*	3-56	1A14J1			
P-F		NUT, PLAIN, HEXAGON P313-0051-000 (77250)	EA	REF	*	*	*	*	*	*	*	*					
P-F	5305-054-6653	SCREW, MACHINE MS51957-29 (96906)	EA	REF	*	*	*	*	*	*	*	*					
P-F	5310-011-104	WASHER, LOCK MS51957-29 (96906)	EA	REF	*	*	*	*	*	*	*	*					
P-H		CLAMP, LOOP C3044-2-35 (78553)	EA	4				*	*	*	*	*					
M-H		CLAMP, LOOP HP6N (09922)	EA	REF													
P-F	5305-054-6654	SCREW, MACHINE MS51957-30 (96906)	EA	REF	*	*	*	*	*	*	*	*					
P-F		WASHER, FLAT 310-6360-000 (79807)	EA	REF	*	*	*	*	*	*	*	*					
P-F		NUT, PLAIN, HEXAGON MS35699-64 (96906)	EA	REF	*	*	*	*	*	*	*	*					
M-H		BAND, MARKER, CABLE 152-3805-000 (04740)	EA	1													
M-H		BAND, MARKER, CABLE 152-3806-000 (04740)	EA	1													
M-H		BAND, MARKER, CABLE 152-3807-000 (04740)	EA	1													
M-H		BAND, MARKER, CABLE 152-3808-000 (04740)	EA	1													
M-H		BAND, MARKER, CABLE 152-3809-000 (04740)	EA	1													
M-H		BAND, MARKER, CABLE 152-3810-000 (04740)	EA	1													
M-H		BAND, MARKER, CABLE 152-3812-000 (04740)	EA	1													

TM11-5820-555-24P  
SECTION II REPAIR PARTS FOR DIRECT SUPPORT, GENERAL SUPPORT, AND DEPOT MAINTENANCE (CONTINUED)

(1) SIB CODE	(2) FEDERAL STOCK NUMBER	(3) DESCRIPTION  USABLE ON CODE	(4) UNIT OF MEAS	(5) QTY INC IN UNIT	(6) 30-DAY DS MAINT ALLOWANCE			(7) 30-DAY GS MAINT ALLOWANCE			(8) 1 YR ALW PER EQUIP CONTACT	(9) DEPOT MAINT ALW PER 100 EQUIP	(10) ILLUSTRATIONS	
					(a)	(b)	(c)	(a)	(b)	(c)			(a) FIG NO.	(b) ITEM NO. OR REFERENCE DESIGNATION
					1-20	21-50	51-100	1-20	21-50	51-100				
M-H		BAND, MARKER, CABLE 152-3813-000 (04740)	EA	1										
M-H		BAND, MARKER, CABLE 152-3814-000 (04740)	EA	1										
M-H		BAND, MARKER, CABLE 152-3815-000 (04740)	EA	1										
M-H		BAND, MARKER, CABLE 152-3816-000 (04740)	EA	1										
M-H		BAND, MARKER, CABLE 152-3817-000 (04740)	EA	1										
M-H		BAND, MARKER, CABLE 152-3818-000 (04740)	EA	1										
M-H		BAND, MARKER, CABLE 152-3819-000 (04740)	EA	1										
M-H		BAND, MARKER, CABLE 152-3820-000 (04740)	EA	1										
M-H		BAND, MARKER, CABLE 152-3821-000 (04740)	EA	1										
M-H		BAND, MARKER, CABLE 152-3822-000 (04740)	EA	1										
P-H		SCREW, MACHINE P325-0080-000 (77250)	EA	4				*	*	*	*	*		
P-O	5310-054-1830	WASHER, LOCK MS35338-80 (96906)	EA	REF	*	*	*	*	*	*	*	*		
P-P	5310-209-1074	WASHER, FLAT 310-0048-000 (79807)	EA	REF	*	*	*	*	*	*	*	*		
GROUP 14 - NETWORK, ANTENNA 180U-2														
A-O		NETWORK, ANTENNA 180U-2 522-1398-000 (13499)	EA	1									3-1	1A2
X1-O		PANEL, MOUNTING 544-7216-004 (13499)	EA	1										
X2-O		BOX, SPEAKER 544-7215-004 (13499)	EA	1										
X1-O		BOX, SPEAKER 544-7214-004 (13499)	EA	1										
P-O	5310-918-7213	NUT, CAPTIVE NCM4-2-2-1 (07886)	EA	REF	*	*	*	*	*	*	*	*		
P-O		NUT, CAPTIVE NCM6-2-2-1 (07886)	EA	REF	*	*	*	*	*	*	*	*		
P-F		BEARING, SLEEVE F300-1MILL6089A (70417)	EA	1	*	*	*	*	*	*	*	*		
X2-O		PANEL, FRONT 544-7212-003 (13499)	EA	1										
X2-O		PLATE, SWITCH 544-7207-003 (13499)	EA	1										
X2-O		COVER, PRESSED LEFT 544-7210-002 (13499)	EA	1										
X2-O		COVER, WELDED 544-7209-002 (13499)	EA	1										
P-O	5310-918-7213	NUT, CAPTIVE NCM4-2-2-1 (07886)	EA	REF	*	*	*	*	*	*	*	*		

TM11-5820-555-24P  
SECTION II REPAIR PARTS FOR DIRECT SUPPORT, GENERAL SUPPORT, AND DEPOT MAINTENANCE (CONTINUED)

(1) SN CODE	(2) FEDERAL STOCK NUMBER	(3) DESCRIPTION  REFERENCE NUMBER & MFR. CODE	(4) UNIT OF MEAS	(5) QTY INC IN UNIT	(6) 30-DAY DS MAINT ALLOWANCE			(7) 30-DAY GS MAINT ALLOWANCE			(8) 1 YR ALUM PER EQUIP CATEGY	(9) DEPOT MAINT ALUM PER 100 EQUIP	(10) FIG NO.	(11) ITEM NO. OR REFERENCE DESIGNATION
					(a) 1-20	(b) 21-50	(c) 51-100	(a) 1-20	(b) 21-50	(c) 51-100				
					USABLE OR CODE									
A-O-R		TURNER, TRANSMISSION LINE 344-7230-000 (13499)	EA	1									1A2A2	
X2-O		TRANSMISSION 544-7219-005 (13499)	EA	1										
X2-O		Bolt-WELDED 544-7218-005 (13499)	EA	1										
P-O		NUT, CAPTIVE NCR6-2-2-1 (J7886)	EA	REF	*	*	*	*	*	*	*	*		
P-H	5950-986-3369	COIL, RADIO FREQUENCY 229-201-3 (74970)	EA	1				*	*	*	*		3-57 1A2A2L1	
P-H		SCREW, MACHINE P342-0167-000 (77250)	EA	4				*	*	*	*			
P-F	5310-2096-6069	WASHER, LOCK 229-201-3 (74970)	EA	REF	*	*	*	*	*	*	*			
P-H		NUT, PLAIN, HEXAGON P313-0093-000 (77250)	EA	REF				*	*	*	*			
P-H	5940-113-3138	TERMINAL, JUG MS20699-2 (96906)	EA	2				*	*	*	*			
P-H	3010-818-1435	COUPLING, SHAFT MB722 (88797)	EA	2				*	*	*	*			
X2-H		SHAFT, STRAIGHT 545-3062-002 (13499)	EA	1										
P-H	3020-678-4049	GEAR SPUR-PRESSED 542-7441-003 (13499)	EA	1				*	*	*	*			
X1-H		BEARING, SLEEVE F346MILL6085A (70417)	EA	REF										
X1-H		GEAR, SPUR-FIXED 542-7422-002 (13499)	EA	1										
X1-H		BEARING, SLEEVE - MODIFIED 545-3061-002 (13499)	EA	1										
X1-H		BEARING, SLEEVE F346MILL6085A (70417)	EA	REF										
P-O		WASHER, LOCK 1722-01CAEFL (78189)	EA	REF	*	*	*	*	*	*	*			
P-O	5310-269-6291	NUT, PLAIN, HEXAGON 8947-151 (04009)	EA	REF	*	*	*	*	*	*	*			
A-F		DIAL, SCALE 542-7425-003 (13499)	EA	1									1A2A2CS2	
P-F	3020-990-5359	GEAR, SPUR-FIXED 542-7416-002 (13499)	EA	REF	*	*	*	*	*	*	*			
P-F	5355-926-5491	DIAL, SCALE 542-7454-004 (13499)	EA	1	*	*	*	*	*	*	*			
P-O	5355-814-4340	KNOB 542-7447-003 (13499)	EA	1	*	*	*	*	*	*	*		3-57 1A2A201	
P-O	5305-054-5648	SCREW, MACHINE MS51957-14 (96906)	EA	REF	*	*	*	*	*	*	*			
X1-F		SKIRT, KNOB, PRESSED 542-7434-003 (13499)	EA	REF										
X1-F		SKIRT, KNOB 542-6944-003 (13499)	EA	REF										
P-O		PIN, SHOULDER, HEADED 542-7415-002 (13499)	EA	REF	*	*	*	*	*	*	*			
X1-F		GEAR, SPUR, KNOB 542-7414-002 (13499)	EA	REF										



SECTION II REPAIR PARTS FOR DIRECT SUPPORT, GENERAL SUPPORT, AND DEPOT MAINTENANCE (CONTINUED)

(1) SNR CODE	(2) FEDERAL STOCK NUMBER	(3) DESCRIPTION  REFERENCE NUMBER & MFR. CODE	(4) UNIT OF MEAS  USABLE ON CODE	(5) QTY INC IN UNIT	(6) 30-DAY DS MAINT ALLOWANCE			(7) 30-DAY GS MAINT ALLOWANCE			(8) 1 YR ALW PER EQUIP CATGCT	(9) DEPOT MAINT ALW PER 100 EQUIP	(10) ILLUSTRATIONS	
					(a) 1-20	(b) 21-50	(c) 51-100	(a) 1-20	(b) 21-50	(c) 51-100			(a) FIG NO.	(b) ITEM NO. OR REFERENCE DESIGNATION
					P-O	5355-774-5221	KNOB, DIAL-COUNTER 542-7411-002 (13499)	EA	REF	*			*	*
P-O	5305-818-9349	SETScrew 328-0022-000 (08664)	EA	REF	*	*	*	*	*	*	*			
XI-F		JIG, ADJUSTING 547-9149-002 (13499)	EA	REF										
M-H		POINTER, DIAL 542-6948-002 (13499)	EA	REF										
P-O		SCREW, MACHINE P321-0292-000 (77250)	EA	2	*	*	*	*	*	*	*			
P-F	5910-755-9120	CAPACITOR, VARIABLE, AIR DIELECTRIC 600E20SP (74970)	EA	1	*	*	*	*	*	*	*	3-57	1A2A2C1	
P-F	5355-814-6639	KNOB, STAKED 543-3250-002 (13499)	EA	1	*	*	*	*	*	*	*	3-57	1A2A202	
XI-F		DIAL, SCALE 280-0202-000 (13499)	EA	1										
XI-F		KNOB S308-64 (75376)	EA	1										
P-F		TERMINAL, LUG 2102-06-00-2520N (78189)	EA	REF	*	*	*	*	*	*	*			
M-F		WIRE, ELECTRICAL 00702-1316 (70567)	FT	REF										
P-F	5930-678-4050	SWITCH, ROTARY 195389DHC (76854)	EA	1	*	*	*	*	*	*	*	3-57	1A2A2S2	
P-F		WASHER, LOCK 1720-02CADPL (78189)	EA	REF	*	*	*	*	*	*	*			
P-F		NUT, PLAIN, HEXAGON P334-4120-000 (77250)	EA	REF	*	*	*	*	*	*	*			
P-O	5355-814-8198	KNOB-MODIFIED 544-7206-002 (13499)	EA	1	*	*	*	*	*	*	*			
XI-O		KNOB C64969-1G (82090)	EA	2								3-57	1A2A204	
XI-O		SETScrew 335-0041-000 (08664)	EA	REF										
P-F	5910-871-6504	SWITCH, ROTARY 195388DHC (76854)	EA	1	*	*	*	*	*	*	*	3-57	1A2A2S1	
P-F		BUSHING, NUT UB241N1PL (37942)	EA	REF	*	*	*	*	*	*	*			
XI-F		KNOB C64969-1G (82090)	EA	REF								3-57	1A2A203	
M-H		SHAFT, SWITCH EXTENSION 544-7205-002 (13499)	EA	1									1A2A2M6	
P-H		COUPLING, SHAFT TX10 (42489)	EA	1				*	*	*	*		1A2A2M7	
X2-H		PLATE, MOUNTING SWITCH 544-7202-002 (13499)	EA	1										
P-F	5950-678-4048	COIL, RADIO FREQUENCY 544-7203-002 (13499)	EA	1	*	*	*	*	*	*	*		1A2A2L2	
M-H		WIRE, ELECTRICAL 00702-1314 (70567)	FT	REF										
P-F	5910-195-8771	CAPACITOR, FIXED, CERAMIC DIELECTRIC 850S100N (71590)	EA	10	*	*	*	*	*	*	*		1A2A2C2	
P-F	5910-195-8771	CAPACITOR, FIXED, CERAMIC DIELECTRIC 850S100N (71590)	EA	REF	*	*	*	*	*	*	*		1A2A2C3	

SECTION II REPAIR PARTS FOR DIRECT SUPPORT, GENERAL SUPPORT, AND DEPOT MAINTENANCE (CONTINUED)

(1) SIR CODE	(2) FEDERAL STOCK NUMBER	(3) DESCRIPTION  USABLE ON CODE	(4) UNIT OF MEAS	(5) QTY INC IN UNIT	(6) 30-DAY GS MAINT ALLOWANCE			(7) 30-DAY GS MAINT ALLOWANCE			(8) 1 YR ALM PER EQUIP CATEGORY	(9) DEPOT MAINT ALM PER 100 EQUIP	(10) ILLUSTRATIONS	
					(a) 1-20	(b) 21-50	(c) 51-100	(a) 1-20	(b) 21-50	(c) 51-100			(a) FIG NO.	(b) ITEM NO. OR REFERENCE DESIGNATION
P-F	5910-195-8771	CAPACITOR, FIXED, CERAMIC DIELECTRIC 850S100H (71590)	EA	REF	*	*	*	*	*	*	*	*		1A2A2C4
P-F	5910-195-8771	CAPACITOR, FIXED, CERAMIC DIELECTRIC 850S100H (71590)	EA	REF	*	*	*	*	*	*	*	*		1A2A2C5
P-F	5910-195-8771	CAPACITOR, FIXED, CERAMIC DIELECTRIC 850S100H (71590)	EA	REF	*	*	*	*	*	*	*	*		1A2A2C6
P-F	5910-195-8771	CAPACITOR, FIXED, CERAMIC DIELECTRIC 850S100H (71590)	EA	REF	*	*	*	*	*	*	*	*		1A2A2C7
P-F	5910-195-8771	CAPACITOR, FIXED, CERAMIC DIELECTRIC 850S100H (71590)	EA	REF	*	*	*	*	*	*	*	*		1A2A2C8
P-F	5910-195-8771	CAPACITOR, FIXED, CERAMIC DIELECTRIC 850S100H (71590)	EA	REF	*	*	*	*	*	*	*	*		1A2A2C9
P-F	5910-195-8771	CAPACITOR, FIXED, CERAMIC DIELECTRIC 850S100H (71590)	EA	REF	*	*	*	*	*	*	*	*		1A2A2C10
P-F	5910-195-8771	CAPACITOR, FIXED, CERAMIC DIELECTRIC 850S100H (71590)	EA	REF	*	*	*	*	*	*	*	*		1A2A2C11
X2-F		PLATE, ELECTRICAL 542-3265-002 (13499)	EA	2										
P-F		SCREW, MACHINE P342-0166-000 (77250)	EA	10	*	*	*	*	*	*	*	*		
P-F		SETS CREW 328-0018-000 (13499)	EA	REF	*	*	*	*	*	*	*	*		
P-F		SETS CREW 328-0507-010 (13499)	EA	REF	*	*	*	*	*	*	*	*		
P-F		SCREW, MACHINE P343-0327-000 (77250)	EA	REF	*	*	*	*	*	*	*	*		
P-F	5310-167-0847	WASHER, LOCK AN93686B (88044)	EA	REF	*	*	*	*	*	*	*	*		
X2-F		COVER, ANTENNA, TUNING 544-7200-002 (13499)	EA	1										
X2-F		COVER, ANTENNA, TUNING 544-7201-002 (13499)	EA	1										
P-F	5305-054-6650	SCREW, MACHINE MS51957-26 (96906)	EA	REF	*	*	*	*	*	*	*	*		
P-F	5310-011-1041	WASHER, LOCK MS35338-79 (96906)	EA	REF	*	*	*	*	*	*	*	*		
P-F	5935-974-5418	CONNECTOR, RECEPTACLE, ELECTRICAL UG58AU (80058)	EA	2	*	*	*	*	*	*	*	*	3-58	1A2A2J3
P-F	5935-974-5418	CONNECTOR, RECEPTACLE, ELECTRICAL UG58AU (80058)	EA	REF	*	*	*	*	*	*	*	*	3-58	1A2A2J4
P-F		SCREW, MACHINE P343-0286-000 (77250)	EA	REF	*	*	*	*	*	*	*	*		
P-F		WASHER, LOCK 310-0076-000 (79807)	EA	REF	*	*	*	*	*	*	*	*		
P-F		NUT, PLAIN, HEXAGON P313-0051-000 (77250)	EA	REF	*	*	*	*	*	*	*	*		
X2-F		RETAINER, CAPACITOR 544-7232-002 (13499)	EA	1										
X2-F		RETAINER, CAPACITOR 544-7231-002 (13499)	EA	1										
P-F	5310-596-6462	NUT, SELF-LOCKING, CLINCH 68NC3-40 (72962)	EA	REF	*	*	*	*	*	*	*	*		

SECTION II REPAIR PARTS FOR DIRECT SUPPORT, GENERAL SUPPORT, AND DEPOT MAINTENANCE (CONTINUED)

(1) SIC CODE	(2) FEDERAL STOCK NUMBER	(3) DESCRIPTION  REFERENCE NUMBER & VER. CODE	(4) UNIT OF MEAS	(5) QTY INC IN UNIT	(6) 30-DAY DS MAINT ALLOWANCE			(7) 30-DAY GS MAINT ALLOWANCE			(8) 1 YR ACUM PER EQUIP CMTGCTY	(9) DEPOT MAINT ALUM PER 100 EQUIP	(10) ILLUSTRATIONS	
					(a) 1-20	(b) 21-50	(c) 51-100	(a) 1-20	(b) 21-50	(c) 51-100			(a) FIG NO.	(b) ITEM NO. OR REFERENCE DESIGNATION
P-F		SCREW, MACHINE P342-0154-000 (77250)	EA	REF	*	*	*	*	*	*	*			
P-F		WASHER, SPRING 542-7417-002 (13499)	EA	REF	*	*	*	*	*	*	*			
P-F		SETSCREW 4-48X1-866PLINE416SST (08665)	EA	REF	*	*	*	*	*	*	*			
A-F		CABLE ASSEMBLY, RADIO FREQUENCY 544-7199-000 (13499)	EA	1									1A2W1	
P-F	5935-722-3190	CONNECTOR, PLUG, ELECTRICAL U0994AU (80058)	EA	1	*	*	*	*	*	*	*	3-58	1A2P4	
P-F	5935-283-2910	CONNECTOR, PLUG, ELECTRICAL RFO235 (94375)	EA	1	*	*	*	*	*	*	*	3-58	1A2P4	
P-F	5935-577-8776	CONNECTOR, PLUG, ELECTRICAL UC21EU (80058)	EA	2	*	*	*	*	*	*	*	3-58	1A2P3	
M-H		CABLE, RADIO FREQUENCY RG213U (80058)	FT	REF										
XI-O		KNOB 540-6241-002 (13499)	EA	1								3-57	1A201	
P-O		SETSCREW 328-0012-000 (08664)	EA	4	*	*	*	*	*	*	*			
P-O	5310-934-9748	NUT, FLAIN, HEXAGON MS35649-44 (96906)	EA	REF	*	*	*	*	*	*	*			
P-F	5305-054-6650	SCREW, MACHINE MS21957-26 (96906)	EA	REF	*	*	*	*	*	*	*			
P-F	5930-655-1508	SWITCH, TOGGLE MS25100-23 (96906)	EA	1	*	*	*	*	*	*	*	3-57	1A2S2	
P-F		BUSHING, NUT UB241N1PL (37942)	EA	REF	*	*	*	*	*	*	*			
P-F	5340-282-0782	RING, RETAINING 5100-25C (79136)	EA	REF	*	*	*	*	*	*	*			
M-H		WIRE, ELECTRICAL 00702-1314 (70567)	FT	REF										
P-F	5985-679-9529	RELAY, ARMATURE 83-3277 (04221)	EA	1	*	*	*	*	*	*	*	3-58	1A2K1	
X2-F		ANGLE-LEFT 545-2914-002 (13499)	EA	1										
P-F		SCREW, MACHINE P343-0328-000 (77250)	EA	REF	*	*	*	*	*	*	*			
P-F	5310-209-6069	WASHER, LOCK 310-0077-000 (79807)	EA	REF	*	*	*	*	*	*	*			
P-F	5935-539-0851	CONNECTOR, ADAPTER UC57BU (81349)	EA	1	*	*	*	*	*	*	*		1A2J9	
A-F		COUPLER, DIRECTIONAL CU987GR110A (80058)	EA	1									1A2A1	
X2-F		CHASSIS, ELECTRICAL 542-4118-003 (13499)	EA	1										
X2-F		ELECTRICAL METER SUBASSEMBLY 542-4112-002 (13499)	EA	1										
P-H		TUBE, BRASS 542-0909-002 (13499)	EA	1				*	*	*	*			
X2-F		SHIELD, COIL 542-4110-002 (13499)	EA	1										
X2-F		PLATE, MOUNTING 542-4113-002 (13499)	EA	1										

SECTION II REPAIR PARTS FOR DIRECT SUPPORT, GENERAL SUPPORT, AND DEPOT MAINTENANCE (CONTINUED)

(1) SIR CODE	(2) FEDERAL STOCK NUMBER	(3) DESCRIPTION  REFERENCE NUMBER & MFR. CODE	(4) UNIT OF MEAS.	(5) QTY REQ. IN UNIT	(6) 30-DAY QS AMOUNT ALLOWANCE			(7) 30-DAY QS AMOUNT ALLOWANCE			(8) A RE ALM PER EQUIP CONTRACT	(9) DEPOT AMOUNT PER EQUIP	(10) FIC NO.	(11) REMARKS OR REFERENCE DESCRIPTION
					(a)	(b)	(c)	(a)	(b)	(c)				
					1-20	21-20	21-100	1-20	21-20	21-100				
X2-F		PLATE, MOUNTING 542-4111-002 (13499)	EA	1										
X2-F		PLATE, FRONT 542-4111-002 (13499)	EA	1										
X2-F		COVER, CHASSIS 542-4117-002 (13499)	EA	1										
P-F		TERMINAL, STUD ST1050-34 (92238)	EA	4	*	*	*	*	*	*	*	*		
P-F		WASHER, LOCK 310-0076-000 (79807)	EA	REF	*	*	*	*	*	*	*	*		
P-F		WASHER, LOCK 310-0078-000 (79807)	EA	4	*	*	*	*	*	*	*	*		
P-F		SCREW, MACHINE P343-0284-000 (77250)	EA	REF	*	*	*	*	*	*	*	*		
P-F	5305-616-2568	SCREW, MACHINE P343-0285-000 (77250)	EA	REF	*	*	*	*	*	*	*	*		
P-F		SCREW, MACHINE P343-0290-000 (77250)	EA	4	*	*	*	*	*	*	*	*		
P-F		SCREW, MACHINE P343-0328-000 (77250)	EA	REF	*	*	*	*	*	*	*	*		
P-F	5961-912-4907	SEMICONDUCTOR DEVICE, DIODE IN82AG (81349)	EA	2	*	*	*	*	*	*	*	*	1A2A1C1	
P-F	5961-912-4907	SEMICONDUCTOR DEVICE, DIODE IN82AG (81349)	EA	REF	*	*	*	*	*	*	*	*	1A2A1C2	
P-F	5935-974-5418	CONNECTOR, RECEPTACLE, ELECTRICAL UG58AU (80058)	EA	2	*	*	*	*	*	*	*	*	3-58 1A2J1	
P-F	5935-5418	CONNECTOR, RECEPTACLE, ELECTRICAL UG58AU (80058)	EA	REF	*	*	*	*	*	*	*	*	3-58 1A2J2	
P-F	5310-958-7252	WASHER, LOCK AN936A416B (88044)	EA	REF	*	*	*	*	*	*	*	*		
P-F	5910-816-9838	CAPACITOR, FIXED, MICA DIELECTRIC CB11RE511J (81349)	EA	2	*	*	*	*	*	*	*	*	1A2A1C3	
P-F	5910-816-9838	CAPACITOR, FIXED, MICA DIELECTRIC CB11RE511J (81349)	EA	REF	*	*	*	*	*	*	*	*	1A2A1C4	
P-F	5910-814-6449	CAPACITOR, FIXED, CERAMIC DIELECTRIC CC301H430F (81349)	EA	2	*	*	*	*	*	*	*	*	1A2A1C5	
P-F	5910-814-6449	CAPACITOR, FIXED, CERAMIC DIELECTRIC CC301H430F (81349)	EA	REF	*	*	*	*	*	*	*	*	1A2A1C6	
P-F	5910-998-1606	CAPACITOR, VARIABLE, GLASS DIELECTRIC VDJ1065D (73899)	EA	2	*	*	*	*	*	*	*	*	1A2A1C1	
P-F	5910-998-1606	CAPACITOR, VARIABLE, GLASS DIELECTRIC VDJ1065D (73899)	EA	REF	*	*	*	*	*	*	*	*	1A2A1C2	
X2-F		COVER, WATTMETER 542-0914-002 (13499)	EA	1										
X1-F		CAN, SHIELD E5265-8 (01634)	EA	1										
P-F	5950-679-9539	COIL, WATTMETER 542-0916-002 (13499)	EA	1	*	*	*	*	*	*	*	*	3-57 1A2A1T1	
M-F		WIRE, ELECTRICAL ANALAC30AWG (81554)	FT	REF										
X1-F		CORE, TOROID 57-1736-6 (92054)	EA	1										
P-H		INSULATION SLEEVING, ELECTRICAL TEPTW26B (81851)	FT	REF				*	*	*	*	*		

SECTION II REPAIR PARTS FOR DIRECT SUPPORT, GENERAL SUPPORT, AND DEPOT MAINTENANCE (CONTINUED)

(1) SR CODE	(2) FEDERAL STOCK NUMBER	(3) DESCRIPTION  REFERENCE NUMBER & MFR. CODE  USABLE OR CODE	(4) UNIT OF MEAS	(5) QTY REQ IN UNIT	(6) 30-DAY DS MAINT ALLOWANCE			(7) 30-DAY GS MAINT ALLOWANCE			(8) 1 YR ALM PER EQUIP CWTGCT	(9) DEPOT MAINT ALM PER 100 EQUIP	(10) ILLUSTRATIONS	
					(a) 1-20	(b) 21-50	(c) 51-100	(a) 1-20	(b) 21-50	(c) 51-100			(a) FIG NO.	(b) ITEM NO. OR REFERENCE DESIGNATION
					P-F	5950-237-1531	COIL, RADIO FREQUENCY 10205-3 (82142)	EA	2	*			*	*
P-F	5950-237-1531	COIL, RADIO FREQUENCY 10205-3 (82142)	EA	REF	*	*	*	*	*	*	*	*	1A2A1L2	
P-F	5950-845-6929	COIL, RADIO FREQUENCY 1537-92 (99800)	EA	2	*	*	*	*	*	*	*	*	1A2A1L1	
P-F	5950-845-6929	COIL, RADIO FREQUENCY 1537-92 (99800)	EA	REF	*	*	*	*	*	*	*	*	1A2A1L2	
M-F		WIRE, ELECTRICAL 00702-1312 (70567)	FT	REF										
M-F		WIRE, ELECTRICAL 00702-1320 (70567)	FT	REF										
P-F	5905-902-5402	RESISTOR, FIXED, FILM RN20XL2R1F (81349)	EA	2	*	*	*	*	*	*	*	*	1A2A1R1	
P-F	5905-902-5402	RESISTOR, FIXED, FILM RN20XL2R1F (81349)	EA	REF	*	*	*	*	*	*	*	*	1A2A1R2	
P-F	5905-883-9198	RESISTOR; SELECT FROM RESISTOR, FIXED, FILM RN65D1001F (81349)	EA	1	*	*	*	*	*	*	*	*	1A2A1R5	
P-F	5905-988-0160	RESISTOR, FIXED, FILM RN65D1051F (81349)	EA	1	*	*	*	*	*	*	*	*	1A2A1R5	
P-F	5905-984-2376	RESISTOR, FIXED, FILM RN65D1101F (81349)	EA	1	*	*	*	*	*	*	*	*	1A2A1R5	
P-F	5905-702-5826	RESISTOR, FIXED, FILM RN65D1151F (81349)	EA	1	*	*	*	*	*	*	*	*	1A2A1R5	
P-F	5905-062-5039	RESISTOR, FIXED, FILM RN65D1211F (81349)	EA	1	*	*	*	*	*	*	*	*	1A2A1R5	
P-F	5905-990-5153	RESISTOR, FIXED, FILM RN65D1271F (81349)	EA	1	*	*	*	*	*	*	*	*	1A2A1R5	
P-F	5905-950-6790	RESISTOR, FIXED, FILM RN65D1331F (81349)	EA	1	*	*	*	*	*	*	*	*	1A2A1R5	
P-F	5905-993-6011	RESISTOR, FIXED, FILM RN65D1401F (81349)	EA	1	*	*	*	*	*	*	*	*	1A2A1R5	
P-F	5905-993-6012	RESISTOR, FIXED, FILM RN65D1471F (81349)	EA	1	*	*	*	*	*	*	*	*	1A2A1R5	
P-F	5905-952-4716	RESISTOR, FIXED, FILM RN65D1541F (81349)	EA	1	*	*	*	*	*	*	*	*	1A2A1R5	
P-F	5905-883-9198	RESISTOR; SELECT FROM RESISTOR, FIXED, FILM RN65D1001F (81349)	EA	1	*	*	*	*	*	*	*	*	1A2A1R6	
P-F	5905-988-0160	RESISTOR, FIXED, FILM RN65D1051F (81349)	EA	1	*	*	*	*	*	*	*	*	1A2A1R6	
P-F	5905-964-2376	RESISTOR, FIXED, FILM RN65D1101F (81349)	EA	1	*	*	*	*	*	*	*	*	1A2A1R6	
P-F	5905-702-5826	RESISTOR, FIXED, FILM RN65D1151F (81349)	EA	1	*	*	*	*	*	*	*	*	1A2A1R6	
P-F	5905-062-5039	RESISTOR, FIXED, FILM RN65D1211F (81349)	EA	1	*	*	*	*	*	*	*	*	1A2A1R6	
P-F	5905-990-5153	RESISTOR, FIXED, FILM RN65D1271F (81349)	EA	1	*	*	*	*	*	*	*	*	1A2A1R6	
P-F	5905-950-6790	RESISTOR, FIXED, FILM RN65D1331F (81349)	EA	1	*	*	*	*	*	*	*	*	1A2A1R6	
P-F	5905-993-6011	RESISTOR, FIXED, FILM RN65D1401F (81349)	EA	1	*	*	*	*	*	*	*	*	1A2A1R6	
P-F	5905-993-6012	RESISTOR, FIXED, FILM RN65D1471F (81349)	EA	1	*	*	*	*	*	*	*	*	1A2A1R6	
P-F	5905-952-4716	RESISTOR, FIXED, FILM RN65D1541F (81349)	EA	1	*	*	*	*	*	*	*	*	1A2A1R6	

SECTION II REPAIR PARTS FOR DIRECT SUPPORT, GENERAL SUPPORT, AND DEPOT MAINTENANCE (CONTINUED)

(1) SIR CODE	(2) FEDERAL STOCK NUMBER	(3) DESCRIPTION  REFERENCE NUMBER & MFR. CODE	(4) USABLE OR CODE	(5) UNIT OF MEAS	(6) QTY INC IN UNIT	(6) 30-DAY GS MAINT ALLOWANCE			(7) 30-DAY GS MAINT ALLOWANCE			(8) A WE ALM PER EQUIP ENTYCY	(9) DEPOT MAINT ALM PER 100 EQUIP	(10) ILLUSTRATIONS  (a) FIG NO.	(11) ITEM NO. OR REFERENCE DESIGNATION
						(a) 1-20	(b) 21-50	(c) 51-100	(a) 1-20	(b) 21-50	(c) 51-100				
P-F	5905-989-5579	RESISTOR, SELECT FROM RESISTOR, FIXED, FILM RN65D7151F (81349)		EA	1	*	*	*	*	*	*	*		1A2A1R3	
P-F	5905-763-9208	- OR - RESISTOR, FIXED, FILM RN65D7321F (81349)		EA	1	*	*	*	*	*	*	*		1A2A1R3	
P-F	5905-892-7283	- OR - RESISTOR, FIXED, FILM RN65D7901F (81349)		EA	1	*	*	*	*	*	*	*		1A2A1R3	
P-F	5905-925-1524	- OR - RESISTOR, FIXED, FILM RN65D7681F (81349)		EA	1	*	*	*	*	*	*	*		1A2A1R3	
P-F	5905-763-3600	- OR - RESISTOR, FIXED, FILM RN65D7871F (81349)		EA	1	*	*	*	*	*	*	*		1A2A1R3	
P-F	5905-989-5577	- OR - RESISTOR, FIXED, FILM RN65D8061F (81349)		EA	1	*	*	*	*	*	*	*		1A2A1R3	
P-F	5905-857-2445	- OR - RESISTOR, FIXED, FILM RN65D8251F (81349)		EA	1	*	*	*	*	*	*	*		1A2A1R3	
P-F	5905-765-5470	- OR - RESISTOR, FIXED, FILM RN65D8451F (81349)		EA	1	*	*	*	*	*	*	*		1A2A1R3	
P-F	5905-763-3601	- OR - RESISTOR, FIXED, F RN65D8661F (81349)		EA	1	*	*	*	*	*	*	*		1A2A1R3	
P-F	5905-957-0453	- OR - RESISTOR, FIXED, F. RN65D8871F (81349)		EA	1	*	*	*	*	*	*	*		1A2A1R3	
P-F	5905-959-6008	- OR - RESISTOR, FIXED, FILM RN65D9091F (81349)		EA	1	*	*	*	*	*	*	*		1A2A1R3	
P-F	5905-950-6793	- OR - RESISTOR, FIXED, FILM RN65D9311F (81349)		EA	1	*	*	*	*	*	*	*		1A2A1R3	
P-F	5905-088-3100	- OR - RESISTOR, FIXED, FILM RN65D9531F (81349)		EA	1	*	*	*	*	*	*	*		1A2A1R3	
P-F	5905-985-2409	- OR - RESISTOR, FIXED, FILM RN65D9761F (81349)		EA	1	*	*	*	*	*	*	*		1A2A1R3	
P-F	5905-064-0555	- OR - RESISTOR, FIXED, FILM RN65D1002F (81349)		EA	1	*	*	*	*	*	*	*		1A2A1R3	
P-F	5905-829-2897	- OR - RESISTOR, FIXED, FILM RN65D14751F (81349)		EA	1	*	*	*	*	*	*	*		1A2A1R3	
P-F	5905-087-4202	- OR - RESISTOR, FIXED, FILM RN65D14871F (81349)		EA	1	*	*	*	*	*	*	*		1A2A1R3	
P-F	5905-892-7276	- OR - RESISTOR, FIXED, FILM RN65D1991F (81349)		EA	1	*	*	*	*	*	*	*		1A2A1R3	
P-F	5905-812-8640	- OR - RESISTOR, FIXED, FILM RN65D5111F (81349)		EA	1	*	*	*	*	*	*	*		1A2A1R3	
P-F	5905-814-0738	- OR - RESISTOR, FIXED, FILM RN65D5231F (81349)		EA	1	*	*	*	*	*	*	*		1A2A1R3	
P-F	5905-989-6488	- OR - RESISTOR, FIXED FILM RN65D5361F (81349)		EA	1	*	*	*	*	*	*	*		1A2A1R3	
P-F	5905-068-5179	- OR - RESISTOR, FIXED FILM RN65D5491F (81349)		EA	1	*	*	*	*	*	*	*		1A2A1R3	
P-F	5905-964-2219	- OR - RESISTOR, FIXED, FILM RN65D5621F (81349)		EA	1	*	*	*	*	*	*	*		1A2A1R3	
P-F	5905-772-1053	- OR - RESISTOR, FIXED, FILM RN65D5761F (81349)		EA	1	*	*	*	*	*	*	*		1A2A1R3	
P-F	5905-225-4027	- OR - RESISTOR, FIXED, FILM RN65D5901F (81349)		EA	1	*	*	*	*	*	*	*		1A2A1R3	
P-F	5905-056-9270	- OR - RESISTOR, FIXED, FILM RN65D6041F (81349)		EA	1	*	*	*	*	*	*	*		1A2A1R3	

SECTION II REPAIR PARTS FOR DIRECT SUPPORT, GENERAL SUPPORT, AND DEPOT MAINTENANCE (CONTINUED)

(1) SQR CODE	(2) FEDERAL STOCK NUMBER	(3) DESCRIPTION  REFERENCE NUMBER & MFR. CODE	USABLE OR CODE	(4) UNIT OF MEAS	(5) QTY REQ IN UNIT	(6) 30-DAY GS MAINT ALLOWANCE			(7) 30-DAY GS MAINT ALLOWANCE			(8) # YR ALW PER EQUIP CATCH	(9) DEPOT MAINT ALW PER EQUIP	(10) ILLUSTRATIONS	
						(a) 1-20	(b) 21-30	(c) 31-100	(a) 1-20	(b) 21-50	(c) 51-100			(a) F-3	(b) F-3
														(10) ITEM NO. OR REFERENCE DESIGNATION	
P-F	5905-081-6381	RESISTOR, FIXED, FILM RM5D6191F (81349) - OR -		EA	1	*	*	*	*	*	*	*	*		1A2A1R3
P-F	5905-763-3599	RESISTOR, FIXED, FILM RM65D6341F (81349) - OR -		EA	1	*	*	*	*	*	*	*	*		1A2A1R3
P-F	5905-068-0066	RESISTOR, FIXED, FILM RM65D6491F (81349) - OR -		EA	1	*	*	*	*	*	*	*	*		1A2A1R3
P-F	5905-051-5557	RESISTOR, FIXED, FILM RM65D6651F (81349) - OR -		EA	1	*	*	*	*	*	*	*	*		1A2A1R3
P-F	5905-060-2481	RESISTOR, FIXED, FILM RM65D6811F (81349) - OR -		EA	1	*	*	*	*	*	*	*	*		1A2A1R3
P-F	5905-704-61963	RESISTOR, FIXED, FILM RM65D6981F (81349) - OR -		EA	1	*	*	*	*	*	*	*	*		1A2A1R3
P-F	5905-989-5579	RESISTOR; SELECT FROM RESISTOR, FIXED, FILM RM65D7151F (81349) - OR -		EA	1	*	*	*	*	*	*	*	*		1A2A1R4
P-F	5905-763-9208	RESISTOR, FIXED, FILM RM65D7321F (81349) - OR -		EA	1	*	*	*	*	*	*	*	*		1A2A1R4
P-F	5905-892-7283	RESISTOR, FIXED, FILM RM65D7501F (81349) - OR -		EA	1	*	*	*	*	*	*	*	*		1A2A1R4
P-F	5905-925-1524	RESISTOR, FIXED, FILM RM65D7681F (81349) - OR -		EA	1	*	*	*	*	*	*	*	*		1A2A1R4
P-F	5905-763-3600	RESISTOR, FIXED, FILM RM65D7871F (81349) - OR -		EA	1	*	*	*	*	*	*	*	*		1A2A1R4
P-F	5905-989-5577	RESISTOR, FIXED, FILM RM65D8061F (81349) - OR -		EA	1	*	*	*	*	*	*	*	*		1A2A1R4
P-F	5905-857-2445	RESISTOR, FIXED, FILM RM65D8251F (81349) - OR -		EA	1	*	*	*	*	*	*	*	*		1A2A1R4
P-F	5905-765-5470	RESISTOR, FIXED, FILM RM65D8451F (81349) - OR -		EA	1	*	*	*	*	*	*	*	*		1A2A1R4
P-F	5905-763-3601	RESISTOR, FIXED, FILM RM65D8661F (81349) - OR -		EA	1	*	*	*	*	*	*	*	*		1A2A1R4
P-F	5905-957-0453	RESISTOR, FIXED, FILM RM65D8871F (81349) - OR -		EA	1	*	*	*	*	*	*	*	*		1A2A1R4
P-F	5905-959-6008	RESISTOR, FIXED, FILM RM65D9091F (81349) - OR -		EA	1	*	*	*	*	*	*	*	*		1A2A1R4
P-F	5905-9506793	RESISTOR, FIXED, FILM RM65D9311F (81349) - OR -		EA	1	*	*	*	*	*	*	*	*		1A2A1R4
P-F	5905-088-3100	RESISTOR, FIXED, FILM RM65D9531F (81349) - OR -		EA	1	*	*	*	*	*	*	*	*		1A2A1R4
P-F	5905-985-2409	RESISTOR, FIXED, FILM RM65D9761F (81349) - OR -		EA	1	*	*	*	*	*	*	*	*		1A2A1R4
P-F	5905-064-0555	RESISTOR, FIXED, FILM RM65D1002F (81349) - OR -		EA	1	*	*	*	*	*	*	*	*		1A2A1R4
P-F	5905-829-2897	RESISTOR, FIXED, FILM RM65D4751F (81349) - OR -		EA	1	*	*	*	*	*	*	*	*		1A2A1R4
P-F	5905-087-4202	RESISTOR, FIXED, FILM RM65D4871F (81349) - OR -		EA	1	*	*	*	*	*	*	*	*		1A2A1R4
P-F	5905-892-7276	RESISTOR, FIXED, FILM RM65D4991F (81349) - OR -		EA	1	*	*	*	*	*	*	*	*		1A2A1R4
P-F	5905-813-8640	RESISTOR, FIXED, FILM RM65D5111F (81349) - OR -		EA	1	*	*	*	*	*	*	*	*		1A2A1R4
P-F	5905-814-0738	RESISTOR, FIXED, FILM RM65D5231F (81349) - OR -		EA	1	*	*	*	*	*	*	*	*		1A2A1R4
P-F	590-989-6488	RESISTOR, FIXED, FILM RM65D5361F (81349) - OR -		EA	1	*	*	*	*	*	*	*	*		1A2A1R4

SECTION II REPAIR PARTS FOR DIRECT SUPPORT, GENERAL SUPPORT, AND DEPOT MAINTENANCE (CONTINUED)

(1) SAC CODE	(2) FEDERAL STOCK NUMBER	(3) DESCRIPTION  REFERENCE NUMBER & AFW. CODE	(4) UNIT OR MEAS	(5) QTY REQ OR UNIT	(6) 30-DAY QS AMOUNT ALLOWANCE			(7) 90-DAY QS AMOUNT ALLOWANCE			(8) A OR ALW RES EQUIP	(9) DEPOT AMOUNT PER EQUIP	(10) FUE NO.	(11) ILLUSTRATIONS ITEM NO. OR REFERENCE SYMBOL
					(a) 1-30	(b) 31-60	(c) 61-90	(a) 1-30	(b) 31-60	(c) 61-90				
P-F	5905-068-5179	RESISTOR, FIXED, FILM RM65D6491F (81349) - OR -	EA	1	*	*	*	*	*	*	*	*	1A2A18A	
P-F	5905-964-2219	RESISTOR, FIXED, FILM RM65D6421F (81349) - OR -	EA	1	*	*	*	*	*	*	*	*	1A2A18A	
P-F	5915-772-1053	RESISTOR, FIXED, FILM RM65D6781F (81349) - OR -	EA	1	*	*	*	*	*	*	*	*	1A2A18A	
P-F	5905-225-4027	RESISTOR, FIXED, FILM RM65D5901F (81349) - OR -	EA	1	*	*	*	*	*	*	*	*	1A2A18A	
P-F	5905-056-9270	RESISTOR, FIXED, FILM RM65D6041F (81349) - OR -	EA	1	*	*	*	*	*	*	*	*	1A2A18A	
P-F	5905-081-6781	RESISTOR, FIXED, FILM RM65D6191F (81349) - OR -	EA	1	*	*	*	*	*	*	*	*	1A2A18A	
P-F	5905-763-3599	RESISTOR, FIXED, FILM RM65D6341F (81349) - OR -	EA	1	*	*	*	*	*	*	*	*	1A2A18A	
P-F	5905-068-0066	RESISTOR, FIXED, FILM RM65D6491F (81349) - OR -	EA	1	*	*	*	*	*	*	*	*	1A2A18A	
P-F	5905-051-5557	RESISTOR, FIXED, FILM RM65D6651F (81349) - OR -	EA	1	*	*	*	*	*	*	*	*	1A2A18A	
P-F	5905-060-2481	RESISTOR, FIXED, FILM RM65D6811F (81349) - OR -	EA	1	*	*	*	*	*	*	*	*	1A2A18A	
P-F	5905-704-6193	RESISTOR, FIXED, FILM RM65D6981F (81349) - OR -	EA	1	*	*	*	*	*	*	*	*	1A2A18A	
P-F		SCREW, MACHINE P343-0286-000 (77250)	EA	REF	*	*	*	*	*	*	*	*		
P-F		TERMINAL, LUG 2104-06-02-2520N (78189)	EA	REF	*	*	*	*	*	*	*	*		
P-F	5310-559-7792	WASHER, LOCK 22H5Q82EG (14655)	EA	REF	*	*	*	*	*	*	*	*		
P-F		SETScrew 335-0001-000 (08664)	EA	1	*	*	*	*	*	*	*	*		
P-F	5325-958-2741	EYELET, METALLIC A2305CADPL (01881)	EA	1	*	*	*	*	*	*	*	*		
P-F		SCREW, MACHINE P343-0299-000 (77250)	EA	4	*	*	*	*	*	*	*	*		
X2-F		PLATE, MOUNTING 542-4114-002 (13499)	EA	2	*	*	*	*	*	*	*	*		
P-F	5910-804-7566	CAPACITOR, FIXED, CERAMIC DIELECTRIC CK70AW102M (81349)	EA	4	*	*	*	*	*	*	*	*	1A2A2C7	
P-F	5910-804-7566	CAPACITOR, FIXED, CERAMIC DIELECTRIC CK70AW102M (81349)	EA	REF	*	*	*	*	*	*	*	*	1A2A2C8	
P-F	5910-804-7566	CAPACITOR, FIXED, CERAMIC DIELECTRIC CK70AW102M (81349)	EA	REF	*	*	*	*	*	*	*	*	1A2A2C9	
P-F	5910-804-7566	CAPACITOR, FIXED, CERAMIC DIELECTRIC CK70AW102M (81349)	EA	REF	*	*	*	*	*	*	*	*	1A2A2C10	
X2-F		BRACKET, ANGLE 545-2913-002 (13499)	EA	1	*	*	*	*	*	*	*	*		
P-F	5305-054-6653	SCREW, MACHINE MS51957-29 (96906)	EA	REF	*	*	*	*	*	*	*	*		
P-F	5310-011-1041	WASHER, LOCK MS35338-79 (96906)	EA	REF	*	*	*	*	*	*	*	*		
P-F	5965-822-8549	LOUDSPEAKER SP5B (80331)	EA	1	*	*	*	*	*	*	*	*	3-57 1A21S1	
P-F		NUT, PLAIN, HEXAGON MS35699-64 (96906)	EA	REF	*	*	*	*	*	*	*	*		



SECTION III REPAIR PARTS FOR DIRECT SUPPORT, GENERAL SUPPORT, AND DEPOT MAINTENANCE (CONTINUED)

(1) SNO CODE	(2) FEDERAL STOCK NUMBER	(3) DESCRIPTION  REFERENCE NUMBER & MFR. CODE	(4) UNIT OR MEAS	(5) QTY INC IN UNIT	(6) 30-DAY DS MAINT ALLOWANCE			(7) 30-DAY GS MAINT ALLOWANCE			(8) I YR ALW PER EQUIP CRTCY	(9) DEPOT MAINT ALW PER 100 EQUIP	(10) ILLUSTRATIONS	
					(a) 1-20	(b) 21-50	(c) 51-100	(a) 1-20	(b) 21-50	(c) 51-100			(a) FIG NO.	(b) ITEM NO. OR REFERENCE DESIGNATION
P-F	5910-615-4101	CAPACITOR, FIXED, CERAMIC DIELECTRIC 327-029X5T0102Z (72982)	EA	4	*	*	*	*	*	*	*	*		1A2C1
P-F	5910-615-4101	CAPACITOR, FIXED, CERAMIC DIELECTRIC 327-029X5T0102Z (72982)	EA	REF	*	*	*	*	*	*	*	*		1A2C2
P-F	5910-615-4101	CAPACITOR, FIXED, CERAMIC DIELECTRIC 327-029X5T0102Z (72982)	EA	REF	*	*	*	*	*	*	*	*		1A2C3
P-F	5910-615-4101	CAPACITOR, FIXED, CERAMIC DIELECTRIC 327-029X5T0102Z (72982)	EA	REF	*	*	*	*	*	*	*	*		1A2C4
P-F	5310-958-7252	WASHER, LOCK MS936A16B (88044)	EA	REF	*	*	*	*	*	*	*	*		
P-F		NUT, PLAIN, HEXAGON F313-0150-000 (77250)	EA	4	*	*	*	*	*	*	*	*		
P-F	5325-276-4993	GROMMET, RUBBER 905 (75543)	EA	REF	*	*	*	*	*	*	*	*		
P-F	5310-042-9609	WASHER, LOCK MS3538-78 (95906)	EA	REF	*	*	*	*	*	*	*	*		
P-F	5305-054-5647	SCREW, MACHINE MS51957-13 (96906)	EA	REF	*	*	*	*	*	*	*	*		
P-F	6625-729-6906	WATTMETER 14-234973 (82386)	EA	1	*	*	*	*	*	*	*	*	3-57	1A2M
P-F	5940-113-8184	TERMINAL, LUG 15BUB730JAL0-3 (90484)	EA	REF	*	*	*	*	*	*	*	*		
P-F	5930-678-4052	SWITCH, ROTARY 205428H1 (76854)	EA	1	*	*	*	*	*	*	*	*	3-57	1A2S1
P-F		WASHER, LOCK 1720-02CAEFL (78189)	EA	REF	*	*	*	*	*	*	*	*		
P-F		NUT, PLAIN, HEXAGON P334-4120-000 (77250)	EA	REF	*	*	*	*	*	*	*	*		
M-H		WIRE, ELECTRICAL MILW16878TYPEB22-9 (81349)	FT	REF										
P-H	5995-832-6854	CABLE ASSEMBLY 546-3409-000 (13499)	EA	1				*	*	*	*	*		
M-H		WIRE, ELECTRICAL MILW16878TYPEB22-90 (81349)	FT	REF										
M-H		WIRE, ELECTRICAL MILW16878TYPEB22-91 (81349)	FT	REF										
M-H		WIRE, ELECTRICAL MILW16878TYPEB22-92 (81349)	FT	REF										
M-H		WIRE, ELECTRICAL MILW16878TYPEB22-902 (81349)	FT	REF										
M-H		WIRE, ELECTRICAL MILW16878TYPEB22-903 (81349)	FT	REF										
M-H		WIRE, ELECTRICAL MILW16878TYPEB22-905 (81349)	FT	REF										
M-H		WIRE, ELECTRICAL MILW16878TYPEB22-906 (81349)	FT	REF										
M-H		WIRE, ELECTRICAL MILW16878TYPEB22-935 (81349)	FT	REF										
M-H		WIRE, ELECTRICAL MILW16878TYPEB22-936 (81349)	FT	REF										
P-H		TAPE, COATED CLOTH GUDELACE18 (82110)	FT	REF				*	*	*	*	*		
P-H		INSULATION SLEEVING, ELECTRICAL TEFTW12B (81851)	FT	REF				*	*	*	*	*		

SECTION III REPAIR PARTS FOR DIRECT SUPPORT, GENERAL SUPPORT, AND DEPOT MAINTENANCE (CONTINUED)

(1) SR CODE	(2) FEDERAL STOCK NUMBER	(3) DESCRIPTION  REFERENCE NUMBER & MFR. CODE	(4) UNIT OF MEAS	(5) QTY INC IN UNIT	(6) 30-DAY DS MAINT ALLOWANCE			(7) 30-DAY GS MAINT ALLOWANCE			(8) 1 YR ALW PER EQUIP CNTGCTY	(9) DEPOT MAINT ALW PER 100 EQUIP	(10) ILLUSTRATIONS	
					(a) 1-20	(b) 21-50	(c) 51-100	(a) 1-20	(b) 21-50	(c) 51-100			(a) FIG NO.	(b) ITEM NO. OR REFERENCE DESIGNATION
P-F	5935-504-3161	CONNECTOR, RECEPTACLE, ELECTRICAL 26-4402-165 (02660)	EA	1	*	*	*	*	*	*	*	*	3-58	1A2JB
M-H		CABLE ASSEMBLY 546-3408-000 (13499)	EA	1										
P-H		CABLE, SPECIAL PURPOSE, ELECTRICAL 1SBUB730N90 (90484)	FT	REF				*	*	*	*	*		
P-H		CABLE, SPECIAL PURPOSE, ELECTRICAL 1SBUB730N91 (90484)	FT	REF				*	*	*	*	*		
P-H	6145-990-8672	CABLE, SPECIAL PURPOSE, ELECTRICAL 1SBUB730N92 (90484)	FT	REF				*	*	*	*	*		
P-H	6145-990-8673	CABLE, SPECIAL PURPOSE, ELECTRICAL 1SBUB730N93 (90484)	FT	REF				*	*	*	*	*		
P-H		INSULATION SLEEVING, ELECTRICAL MIL13190CLBALSIZ4-0 (81349)	FT	REF				*	*	*	*	*		
M-H		WIRE, ELECTRICAL MIL13190CLBALSIZ4-0 (81349)	FT	REF										
M-H		WIRE, ELECTRICAL MILW16878TYPEB22-95 (81349)	FT	REF										
P-H		TAPE, COATED CLOTH GUDELACE18 (82110)	FT	REF				*	*	*	*	*		
M-H		CABLE ASSEMBLY 546-3407-000 (13499)	EA	1										
M-H		WIRE, ELECTRICAL MILW16878TYPEB22-92 (81349)	FT	REF										
M-H		WIRE, ELECTRICAL MILW16878TYPEB22-903 (81349)	FT	REF										
M-H		WIRE, ELECTRICAL MILW16878TYPEB22-9G5 (81349)	FT	REF										
M-H		WIRE, ELECTRICAL MILW16878TYPEB22-935 (81349)	FT	REF										
P-H		INSULATION SLEEVING, ELECTRICAL MIL13190CLBALSIZ6-0 (81349)	FT	REF				*	*	*	*	*		
P-H		TAPE, COATED CLOTH GUDELACE18 (82110)	FT	REF				*	*	*	*	*		
P-H	3010-818-1435	COUPLING, SHAFT MB722 (88797)	EA	REF				*	*	*	*	*		
P-F	5930-060-2226	SWITCH SECTION, ROTARY 197467DHC (76854)	EA	1	*	*	*	*	*	*	*	*	3-57	1A253B
P-F	5930-060-2227	SWITCH SECTION, ROTARY 197468DH (76854)	EA	1	*	*	*	*	*	*	*	*	3-57	1A253A
P-H		DETENT, SWITCH 197469H (76854)	EA	1				*	*	*	*	*		
P-F		SETScrew 4-48X-86SPLINE416SST (08665)	EA	REF	*	*	*	*	*	*	*	*		
P-F		WASHER, LOCK 1724-02CADPL (78189)	EA	REF	*	*	*	*	*	*	*	*		
P-F		WASHER, NONMETALLIC 303-1000-000 (79807)	EA	4	*	*	*	*	*	*	*	*		
P-F		WASHER, FLAT 310-0131-000 (05411)	EA	REF	*	*	*	*	*	*	*	*		
P-F		SCREW, MACHINE P342-0153-000 (77250)	EA	REF	*	*	*	*	*	*	*	*		
P-F		SCREW, MACHINE P343-0284-000 (77250)	EA	REF	*	*	*	*	*	*	*	*		

SECTION III REPAIR PARTS FOR DIRECT SUPPORT, GENERAL SUPPORT, AND DEPOT MAINTENANCE (CONTINUED)

(1) SIR CODE	(2) FEDERAL STOCK NUMBER	(3) DESCRIPTION  USABLE ON CODE	(4) UNIT OF MEAS	(5) QTY INC IN UNIT	(6) 30-DAY DS MAINT ALLOWANCE			(7) 30-DAY GS MAINT ALLOWANCE			(8) I YR ALW PER EQUIP CATGCT	(9) DEPOT MAINT ALW PER 100 EQUIP	(10) ILLUSTRATIONS	
					(a) 1-20	(b) 21-50	(c) 51-100	(a) 1-20	(b) 21-50	(c) 51-100			(a) FIG NO.	(b) ITEM NO. OR REFERENCE DESIGNATION
P-F		SCREW, MACHINE P343-0286-000 (77250)	EA	REF	*	*	*	*	*	*	*			
P-F		WASHER, LOCK 310-0076-000 (79807)	EA	REF	*	*	*	*	*	*	*			
P-F	5305-763-6962	SCREW, MACHINE MS51959-27 (96906)	EA	REF	*	*	*	*	*	*	*			
P-F		WASHER, FLAT 310-6360-000 (79807)	EA	REF	*	*	*	*	*	*	*			
P-F	5935-974-5418	CONNECTOR, RECEPTACLE, ELECTRICAL UG58AU (80058)	EA	3	*	*	*	*	*	*	*	3-58	1A2J9	
P-F	5935-974-5418	CONNECTOR, RECEPTACLE, ELECTRICAL UG58AU (80058)	EA	REF	*	*	*	*	*	*	*	3-58	1A2J10	
P-F	5935-974-5418	CONNECTOR, RECEPTACLE, ELECTRICAL UG58AU (80058)	EA	REF	*	*	*	*	*	*	*	3-58	1A2J11	
P-F		NUT, PLAIN, HEXAGON P313-0051-000 (77250)	EA	REF	*	*	*	*	*	*	*			
P-O	5305-054-5648	SCREW, MACHINE MS51957-14 (96906)	EA	REF	*	*	*	*	*	*	*			
P-F	5905-279-1692	RESISTOR, FIXED, COMPOSITION RC32GF100K (81349)	EA	2	*	*	*	*	*	*	*		1A2R1	
P-F	5905-279-1692	RESISTOR, FIXED, COMPOSITION RC32GF100K (81349)	EA	REF	*	*	*	*	*	*	*		1A2R2	
P-H	5310-061-9245	POST, SPACING 540-9037-003 (13499)	EA	REF				*	*	*	*			
X2-F		SHAFT, STRAIGHT, SWITCH 545-2917-002 (13499)	EA	1										
X2-F		BRACKET, DETENT 545-2918-002 (13499)	EA	1										
X2-F		SHIELD, SWITCH 545-2921-003 (13499)	EA	1										
P-F		NUT, CAPTIVE 543-0435-002 (13499)	EA	REF	*	*	*	*	*	*	*			
X2-F		SHIELD, SWITCH 545-2920-003 (13499)	EA	1										
X2-F		COVER, SWITCH 545-2915-002 (13499)	EA	1										
X2-F		PLATE, SWITCH 545-2916-002 (13499)	EA	1										
P-F	5935-577-8776	CONNECTOR, PLATE, ELECTRICAL UG21EU (80058)	EA	REF	*	*	*	*	*	*	*		1A2P5	
M-H		BAG, COTTON, DUCK 024-0100-000 (13499)	EA	REF										
A-F		KL., MOUNTING 541-1477-002 (13499)	EA	REF										
M-H		BAG, COTTON, DUCK 024-0100-000 (13499)	EA	REF										
P-F	5310-054-1830	WASHER, LOCK MS35338-80 (96906)	EA	REF	*	*	*	*	*	*	*			
P-F		WASHER, FLAT 310-0167-000 (79807)	EA	REF	*	*	*	*	*	*	*			
P-F		WASHER, LOCK 310-0286-000 (13499)	EA	REF	*	*	*	*	*	*	*			
P-F	5305-579-3507	SCREW, MACHINE MS35216-40 (96906)	EA	REF	*	*	*	*	*	*	*			

SECTION III REPAIR PARTS FOR DIRECT SUPPORT, GENERAL SUPPORT, AND DEPOT MAINTENANCE (CONTINUED)

(1) SR CODE	(2) FEDERAL STOCK NUMBER	(3) DESCRIPTION  USABLE ON CODE	(4) UNIT OF MEAS	(5) QTY INC IN UNIT	(6) 30-DAY DS MAINT ALLOWANCE			(7) 30-DAY GS MAINT ALLOWANCE			(8) 1 YR ALW PER EQUIP CNTGTY	(9) DEPOT MAINT ALW PER 100 EQUIP	(10) ILLUSTRATIONS	
					(a) 1-20	(b) 21-50	(c) 51-100	(a) 1-20	(b) 21-50	(c) 51-100			(a) FIG NO.	(b) ITEM NO. OR REFERENCE DESIGNATION
P-F		SCREW, MACHINE P343-0247-000 (77250)	EA	REF	*	*	*	*	*	*	*			
P-F	5340-619-7754	CLAMP, LOOP HP2N (09922)	EA	REF	*	*	*	*	*	*	*			
P-F		TERMINAL, LUG 3102-04-00HOTTINNED (78189)	EA	1	*	*	*	*	*	*	*			
P-F	5305-054-6652	SCREW, MACHINE MS51957-28 (96906)	EA	REF	*	*	*	*	*	*	*			
M-F		WIRE, ELECTRICAL 00702-1320 (70567)	FT	REF										
P-F		INSULATION SLEEVING, ELECTRICAL SIZE20-0 (81349)	FT	REF	*	*	*	*	*	*	*			
X2-F		PLATE, IDENTIFICATION 280-1254-000 (12998)	EA	REF										
P-F	5305-054-5636	SCREW, MACHINE MS51957-2 (96906)	EA	REF	*	*	*	*	*	*	*			
M-D		PLATE, IDENTIFICATION 280-0450-000 (74048)	EA	REF										

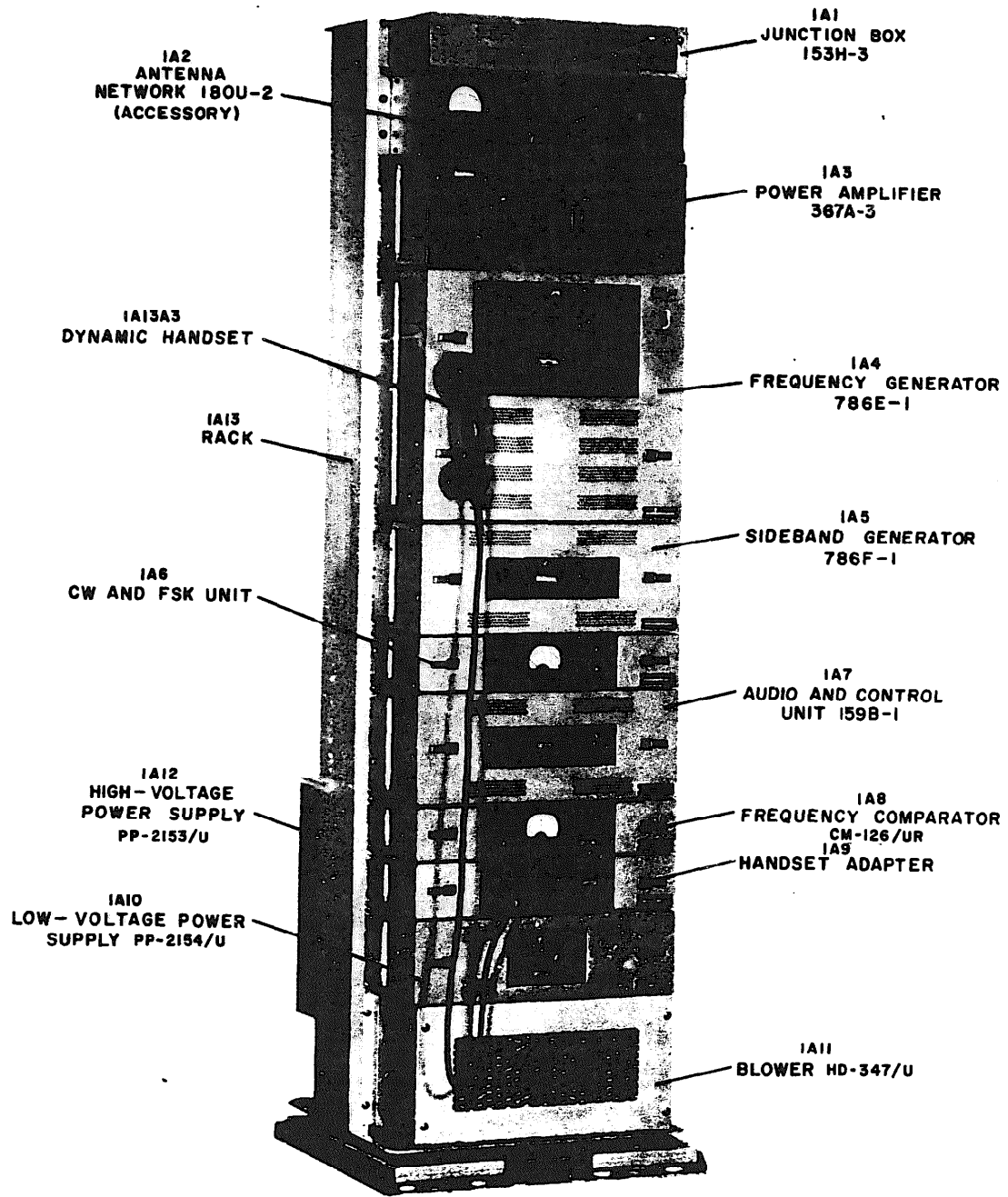

EL5820-555-24P-TM-1

Figure 3-1. Major components, Transceiver KWT-6, front view.

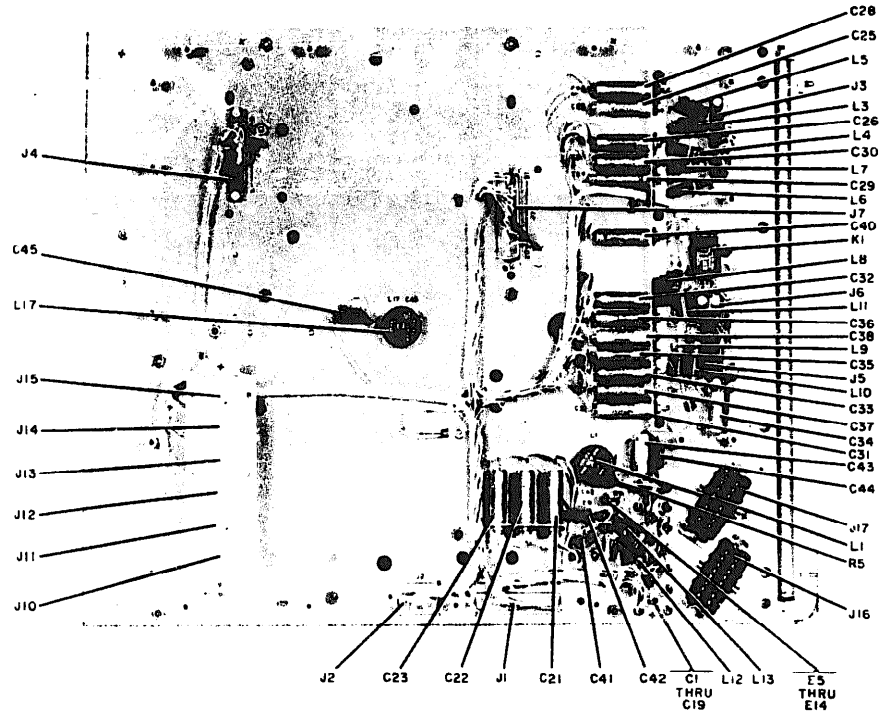

**EL5820-555-24P-TM-2**

Figure 3-2. Frequency Generator 786E-1, rear view, cover removed (1A4).

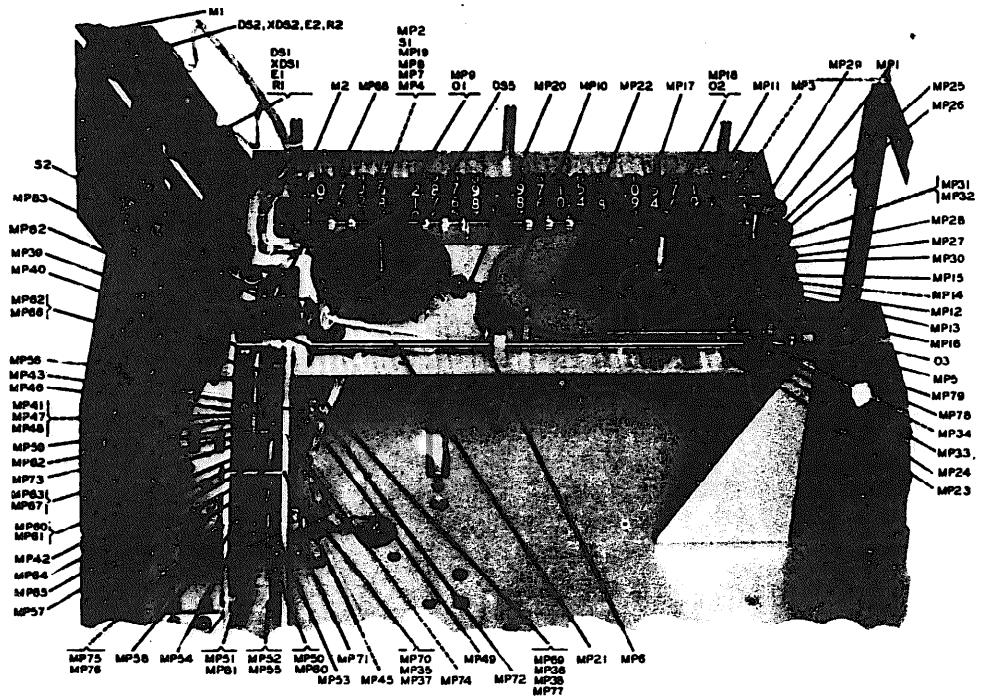

EL 5820-555-24P-TM-3

Figure 3-3. Frequency Generator 786E-1, front view (1A4).

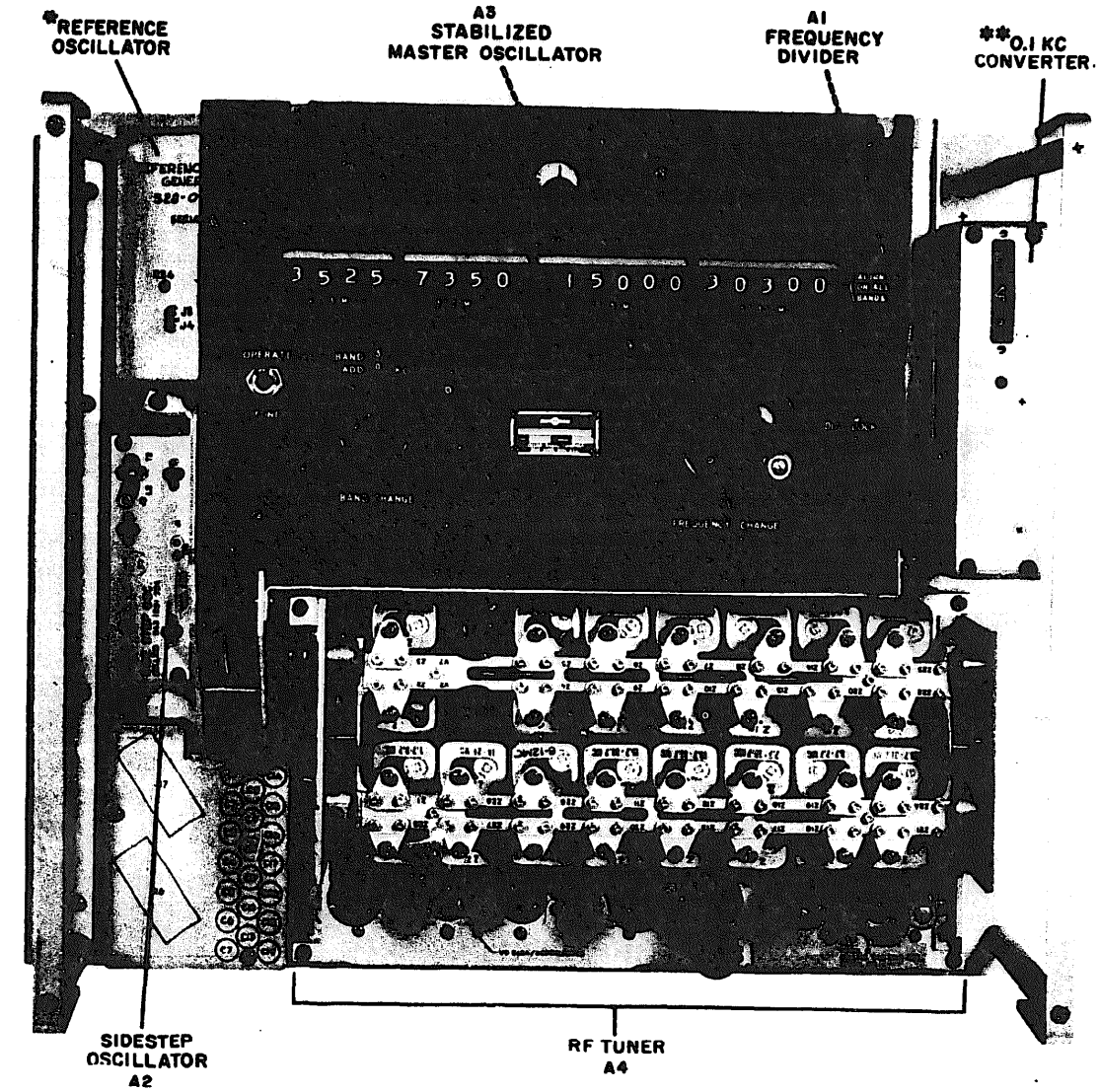

\* ISOLATION AMPLIFIER (NOT SHOWN) REPLACES REFERENCE OSCILLATOR  
\*\* (OPTIONAL) REPLACED BY DUMMY PLUG.

EL5820-555-24P-TM-4

Figure 3-4. Frequency Generator 786E-1, module location (1A4).



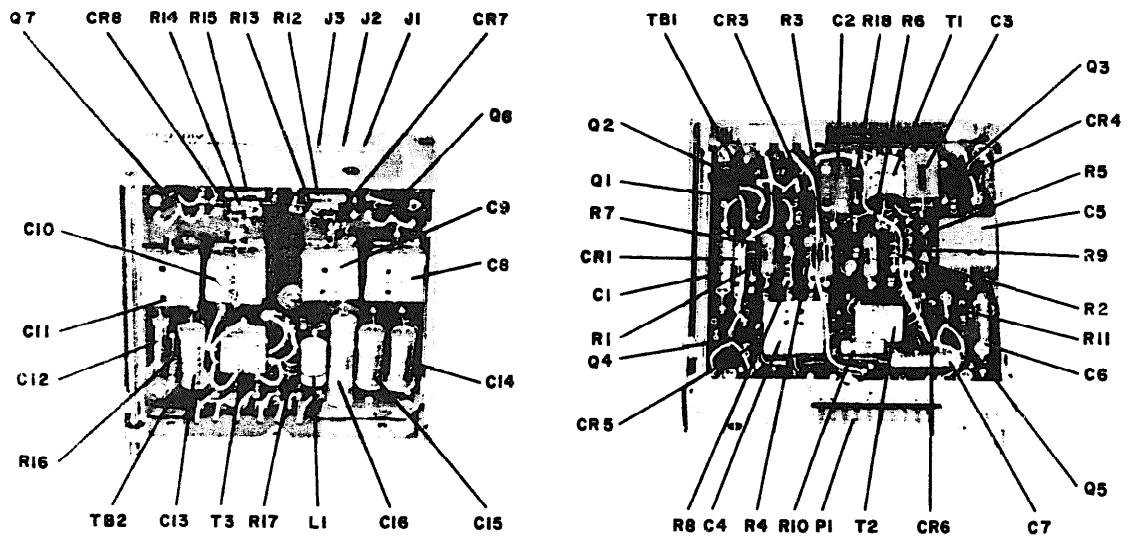

EL 5820-555-24P-TM-5

Figure 3-5. Frequency divider module (1A4A1).

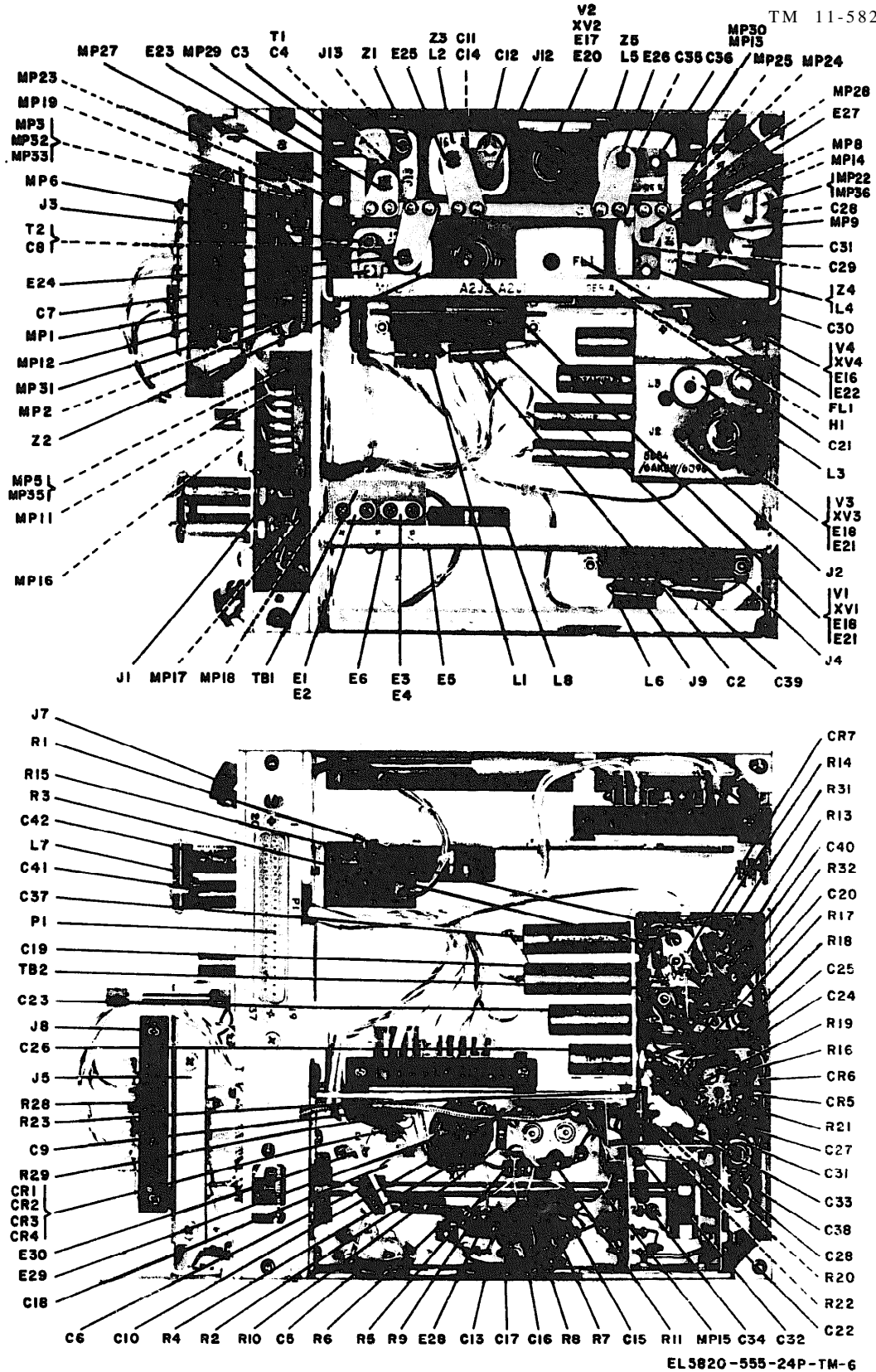

EL5820-555-24P-TM-6

Figure 3-6. Stabilized Master Oscillator, Model A, master oscillator assembly (1A4A3).

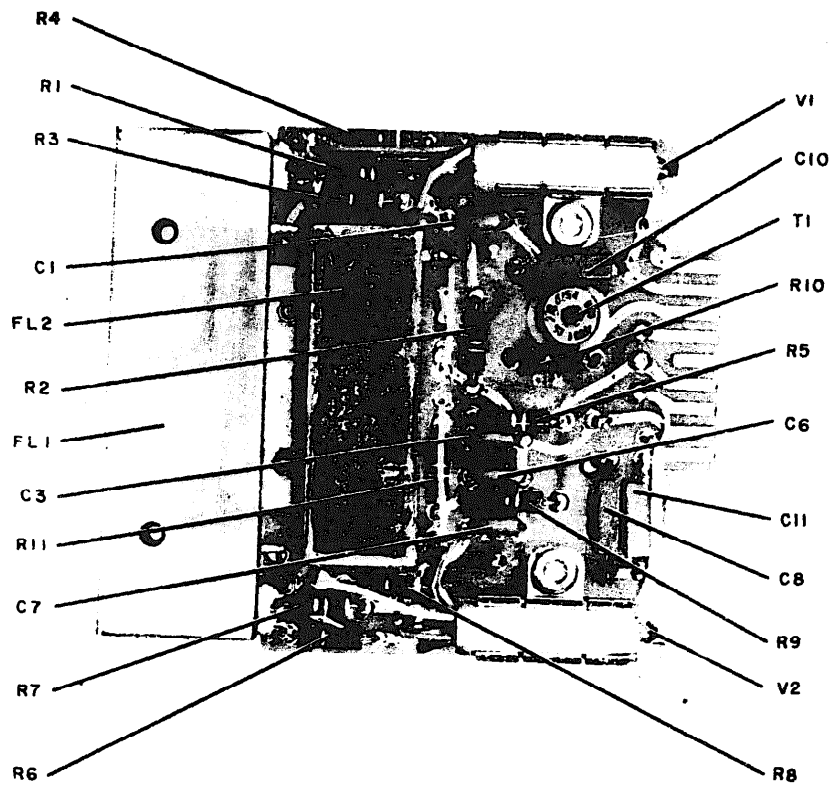

**EL5820-555-24P-TM-7**

Figure 3-7. Stabilized Master Oscillator Module, Model C, i-f mixer assembly (IA4A3A3).

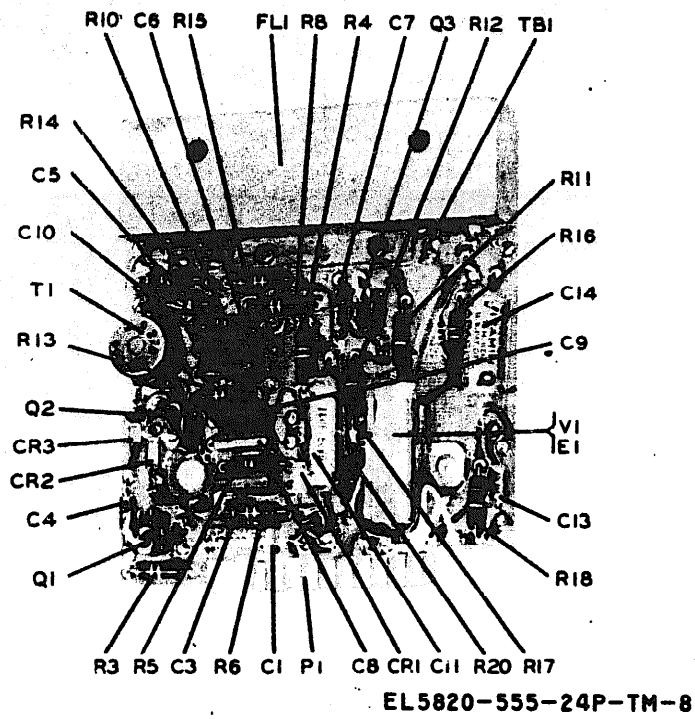
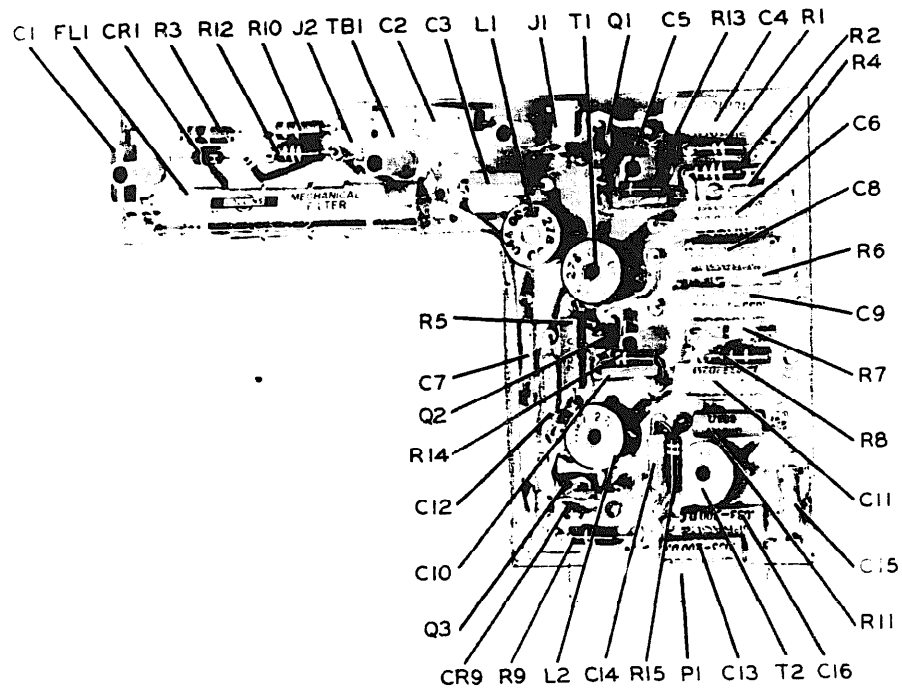

Figure 3-8. Stabilized master oscillator module, 4-kc spectrum generator assembly (1A4A3A6).



**EL 5820-555-24P-TM-9**

Figure 3-9. Stabilized master oscillator module, reference i-f amplifier (1A4A3A7).

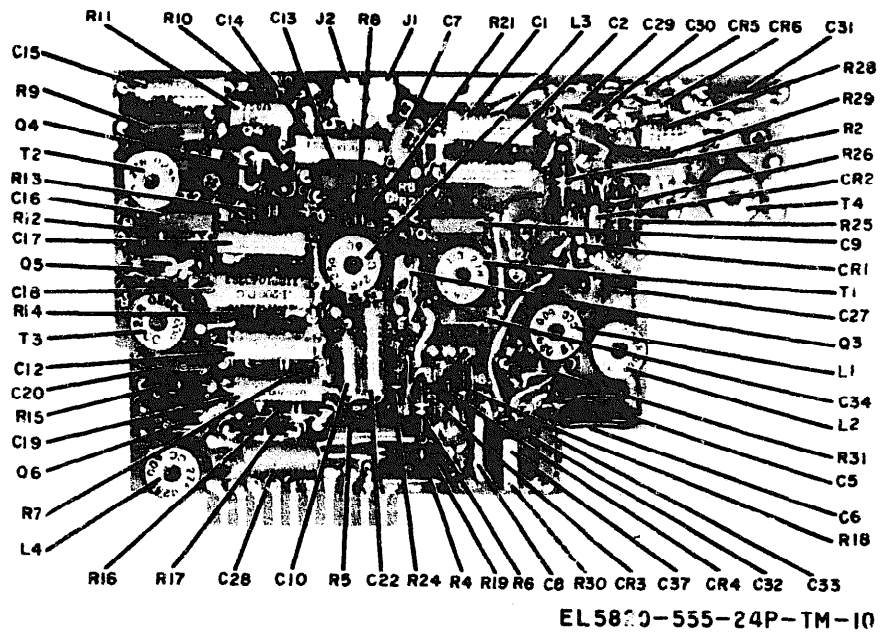
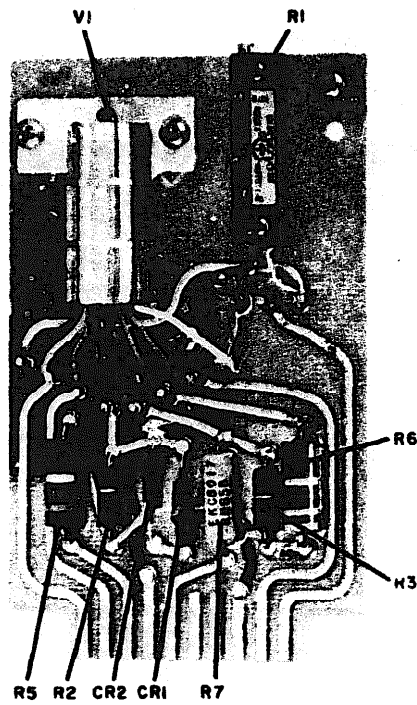
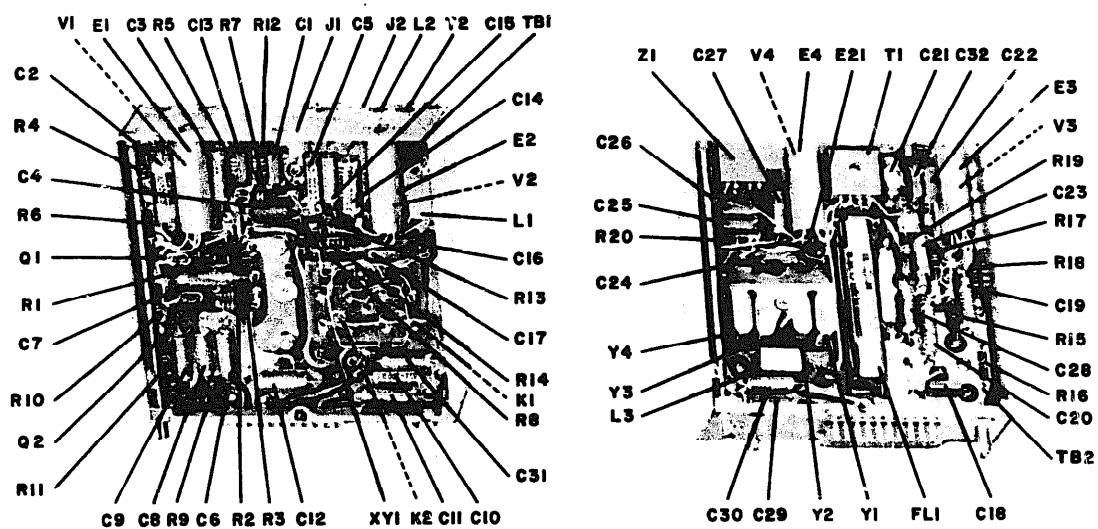

Figure 3-10. Stabilized Master Oscillator, Model B, i-f amplifier board (1A4A3A2).



**EL5820-555-24P-TM-11**

Figure 3-11. Stabilized Master Oscillator, Models B and C, meter amplifier board (1A4A3A8).



EL 5820-555-24P-TM-12

Figure 3-12. Sidestep oscillator module (IA4A2).



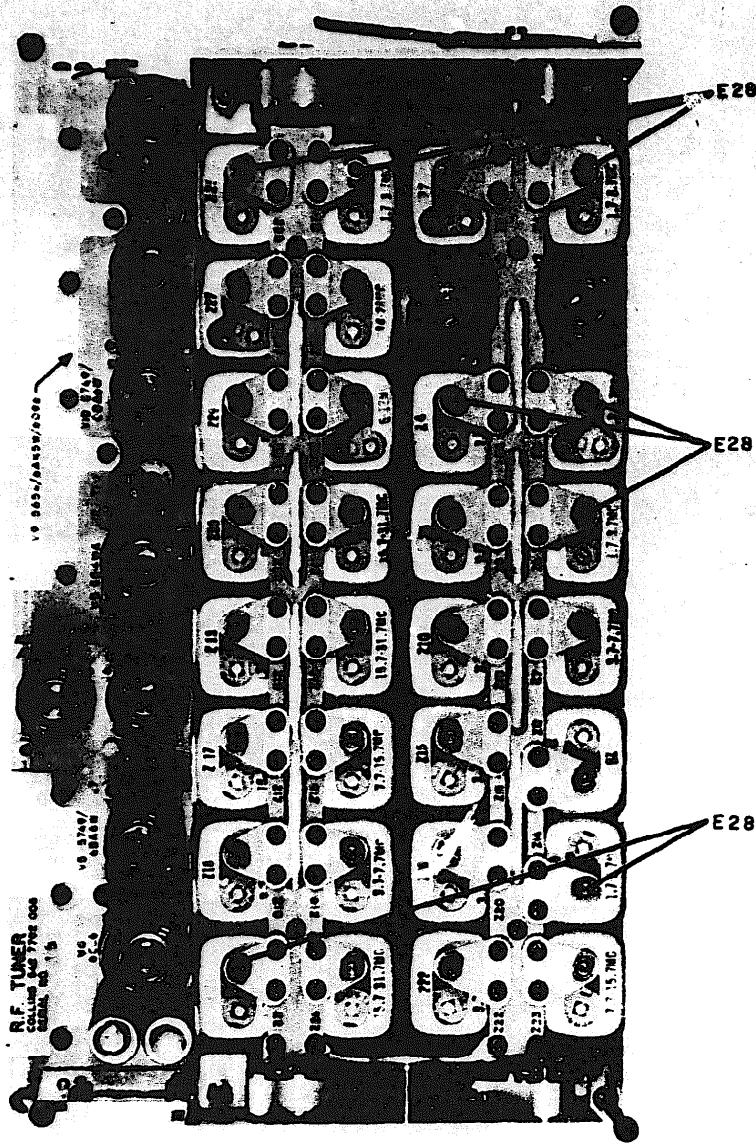

NOTE: 1. ALL CORES NOT KEYED ARE E24  
2. ALL OTHER KEYED COMPONENTS ARE THE SAME AS THAT SHOWN IN FIGURE 4-5

EL5820-555-24P-TM-13

Figure 3-13. R-F Tuner Module, Model B, front view (1A4A4).

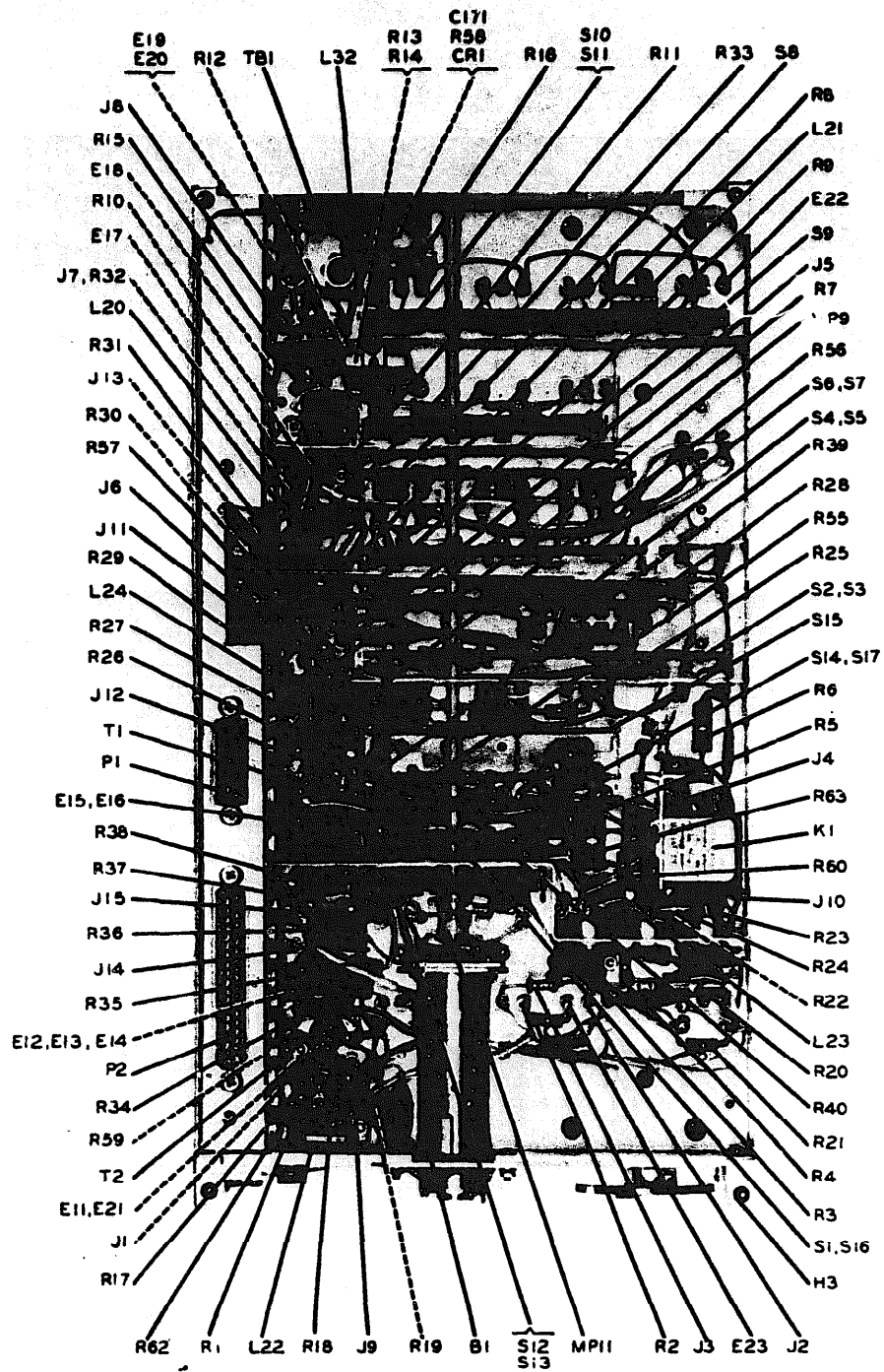

EL 5820-555-24P-TM-14

Figure 3-14. R-F tuner module, rear view (1A4A4).

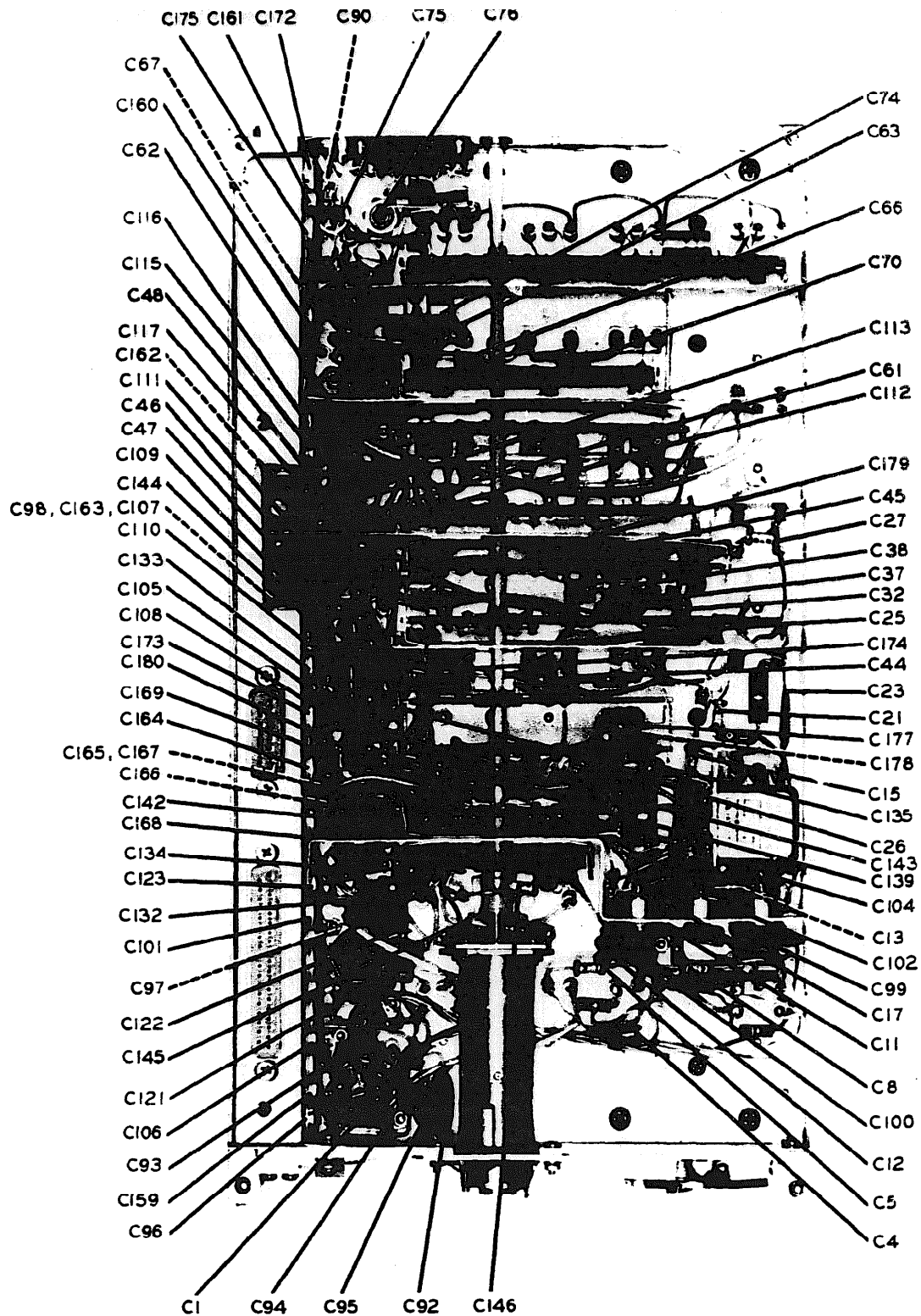

EL 5820-555-24P-TM-15

Figure 3-15. R-F tuner module, capacitor location (1A4A4).

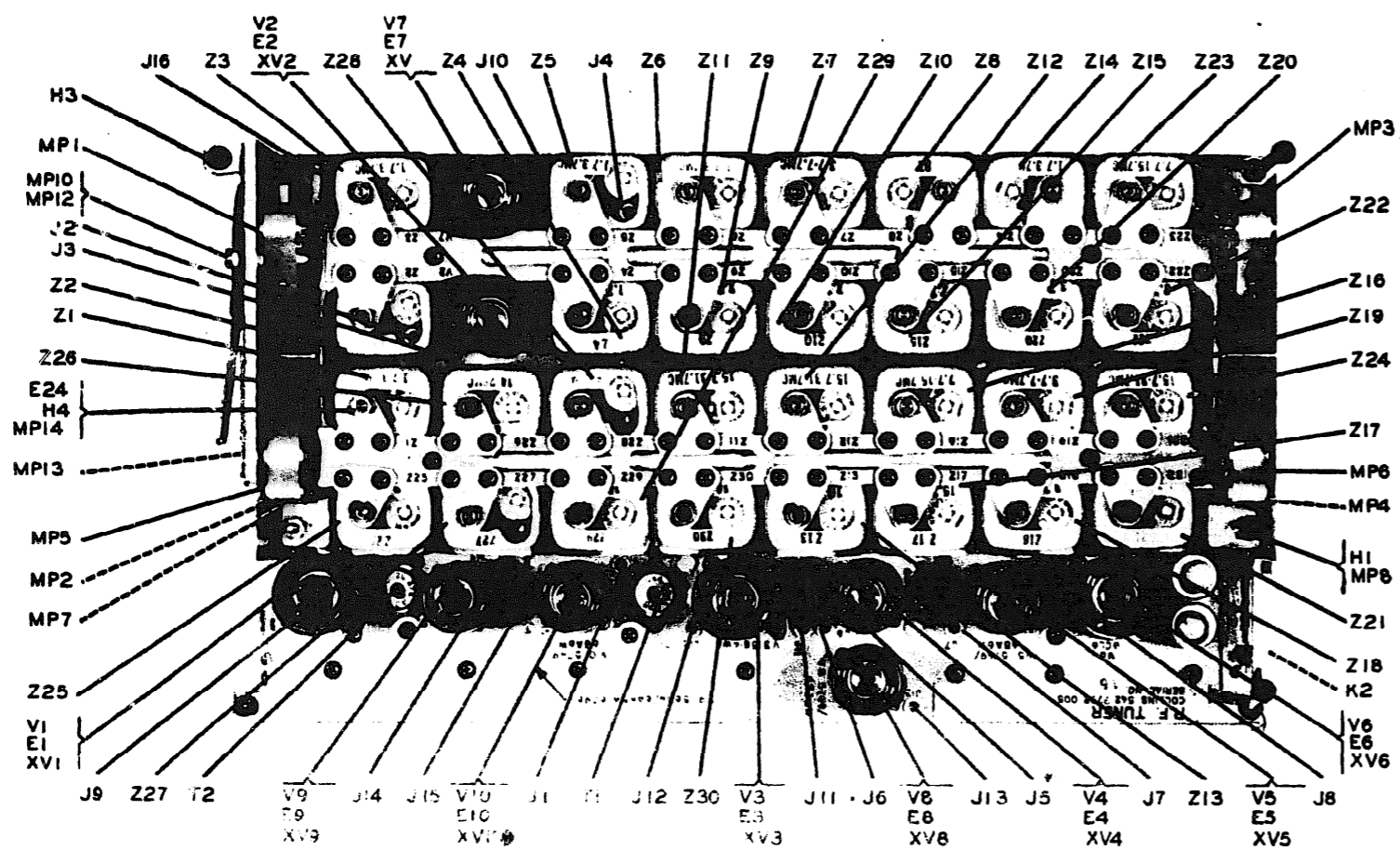

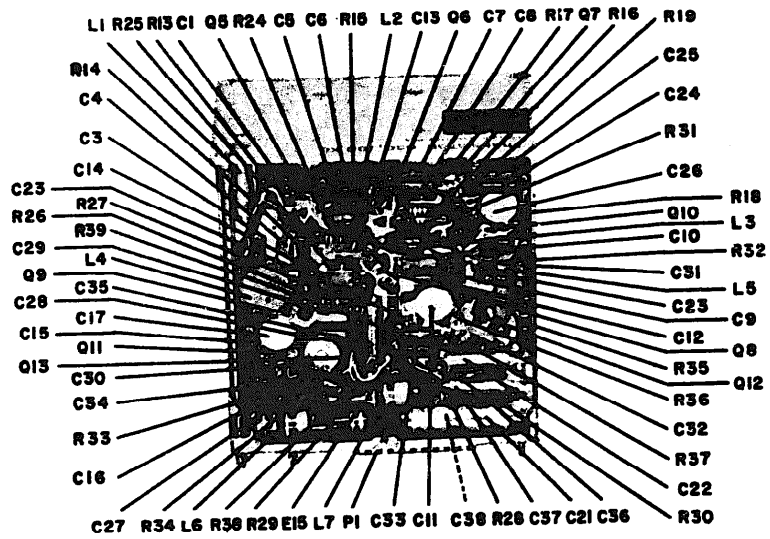
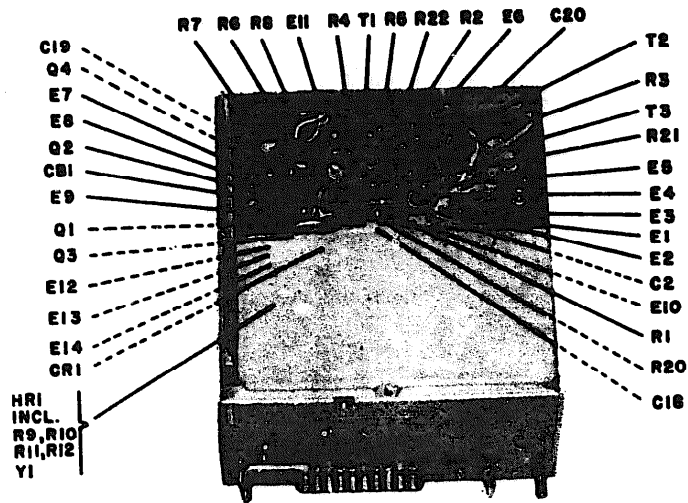

EL5820-555-24P-TM-17

Figure 3-17. Reference oscillator module (1A4A5).

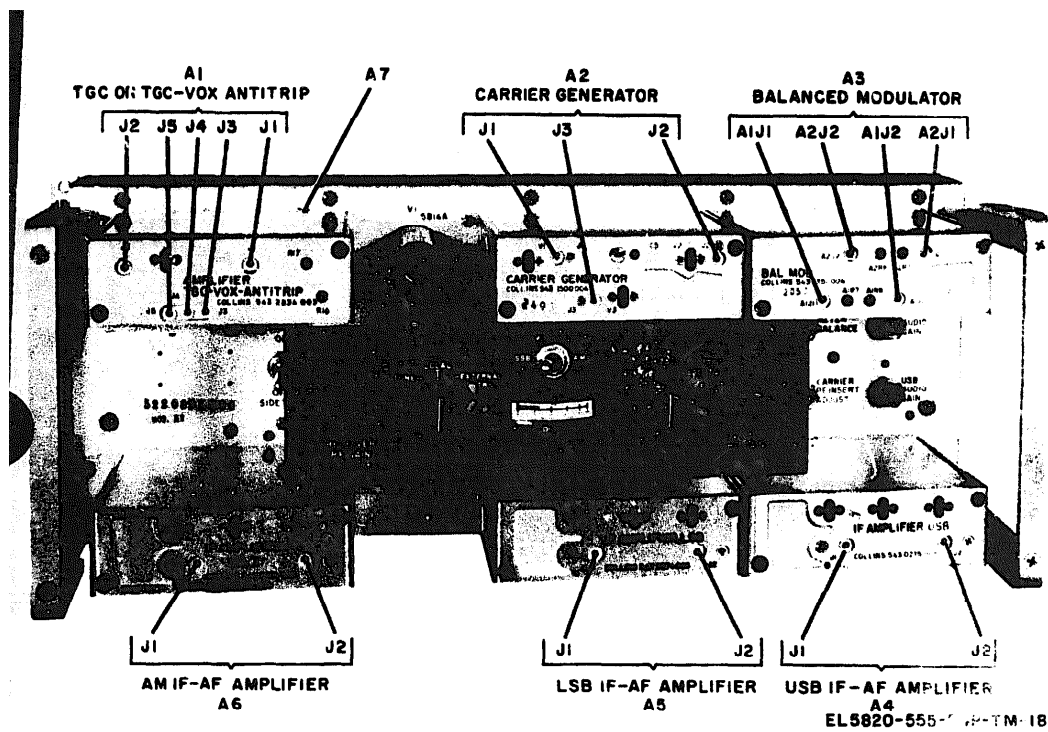
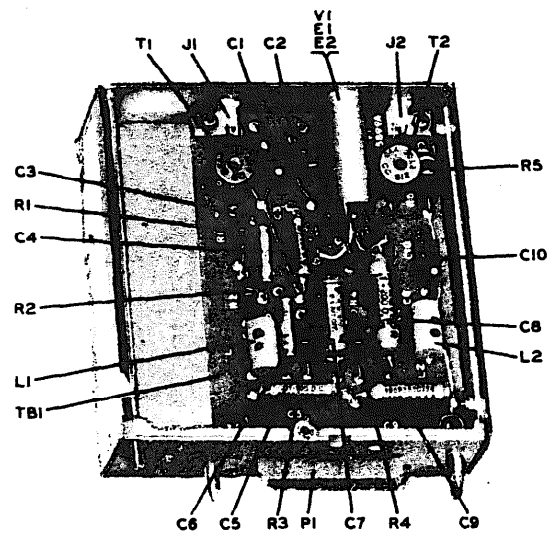

Figure 3-18. Sideband Generator 786F-1, module location (145).



**EL5820-555-24P-TM-19**

Figure 3-19. TGC module and tgc-vox anti-vox module, tgc assembly, cover removed (1A5A1).

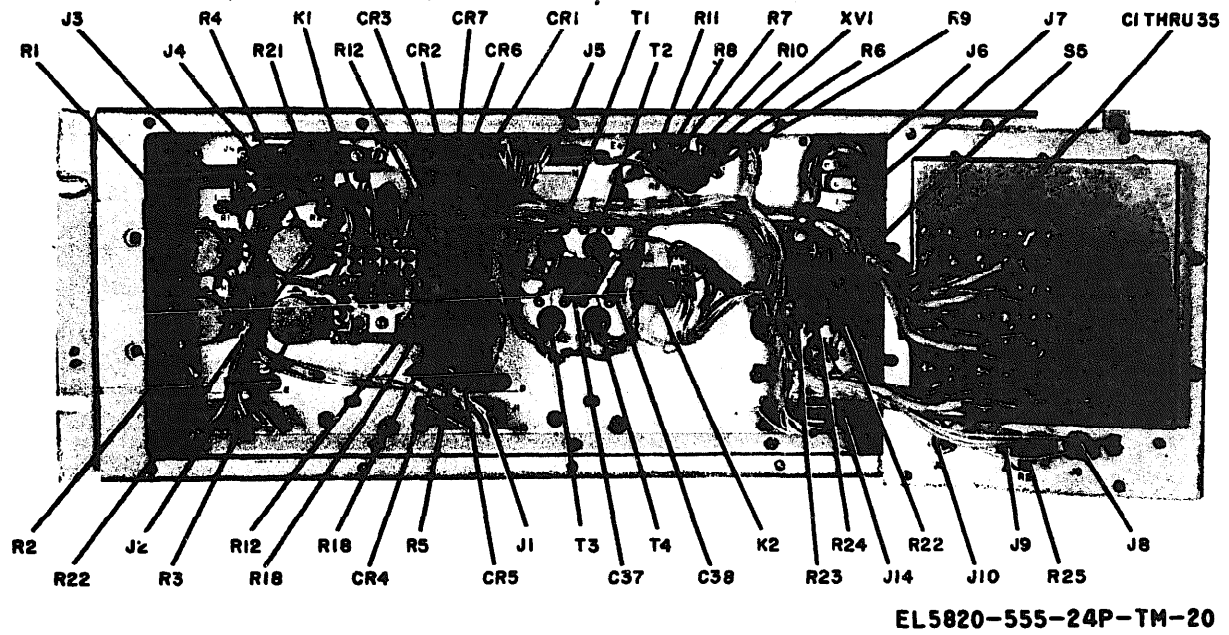

Figure 3-20. Sideband Generator 786F-1 chassis, rear view, cover removed (1A5A7).



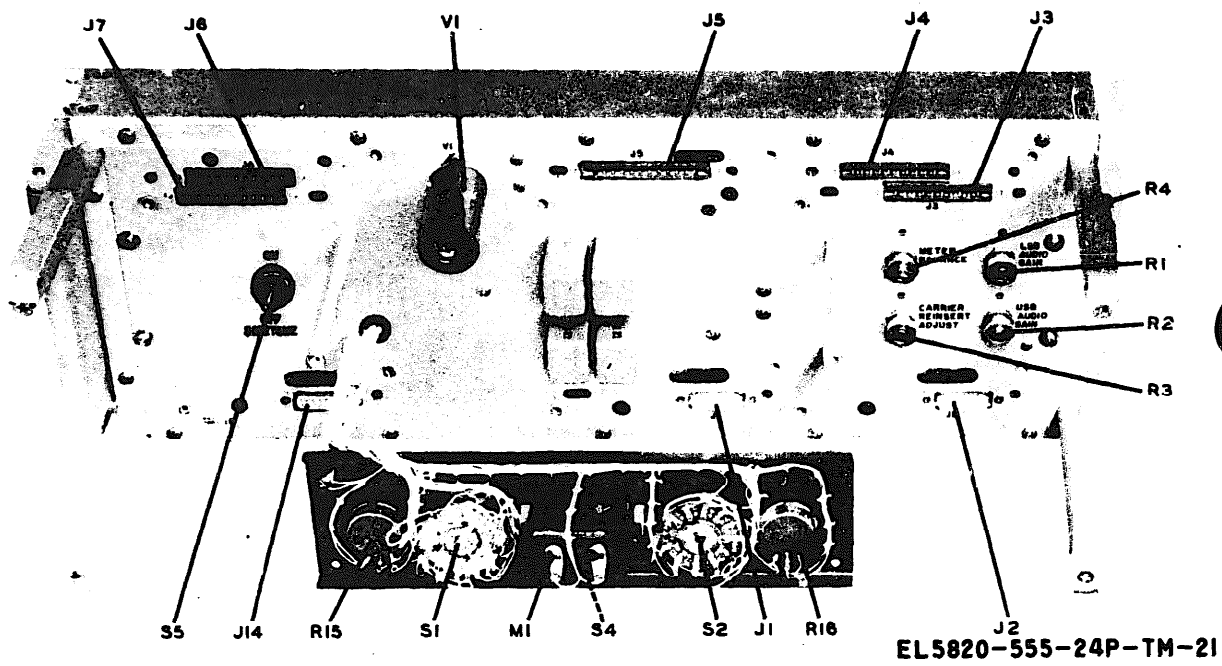

Figure 3-21. Sideband Generator 786F-1 chassis, front view (1A5A7).

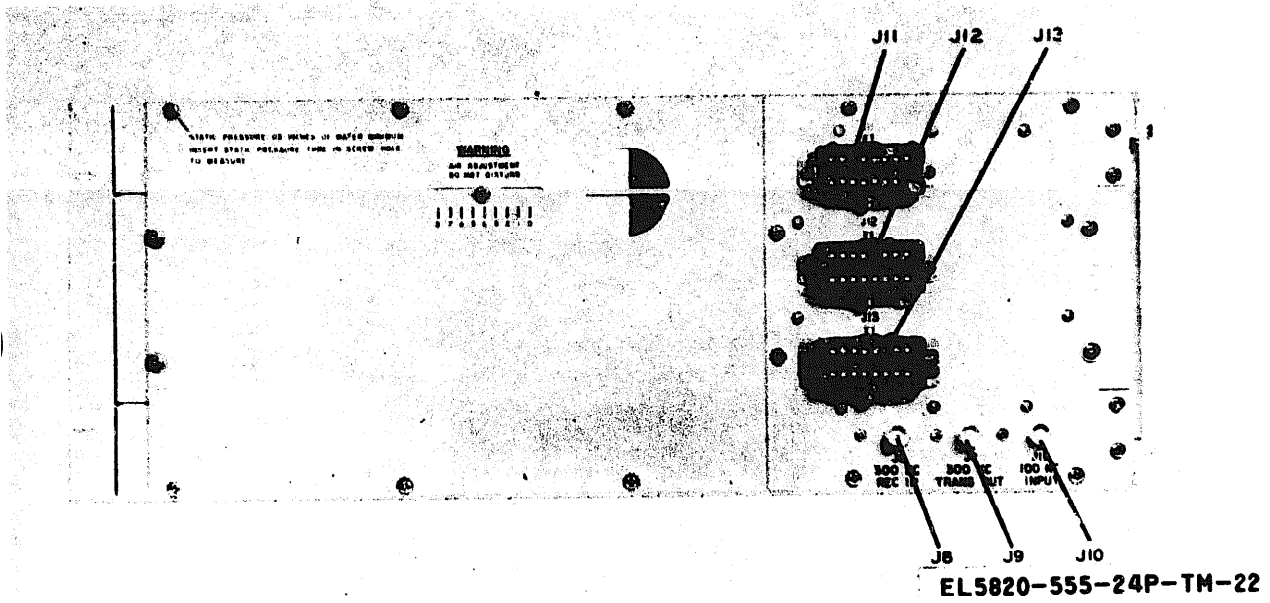
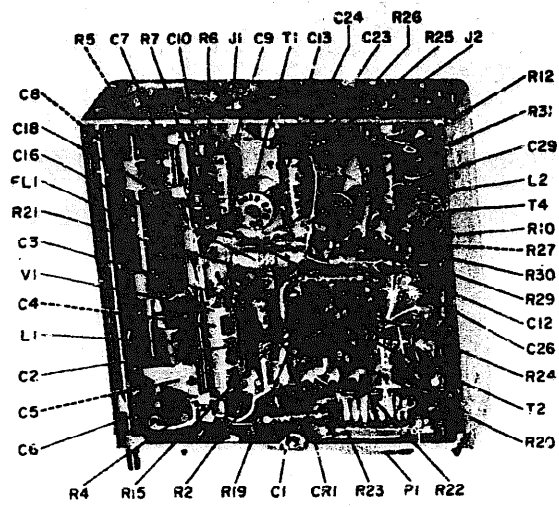
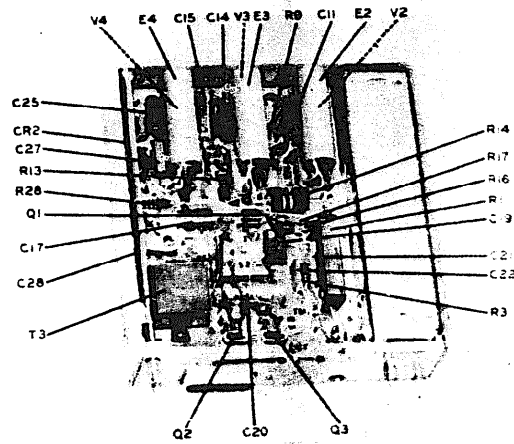

Figure 3-22. Sideband Generator 786F-1 chassis, rear view (1A5A7).



EL5820-555-24P-TM-23

Figure 3-23. LSB i-fla-f amplifier module front view, cover removed (1A5A5).



**EL5820-555-24P-TM-24**

Figure 3-24. LSB i-fla-f amplifier module, rear view, cover removed (IA5A5).

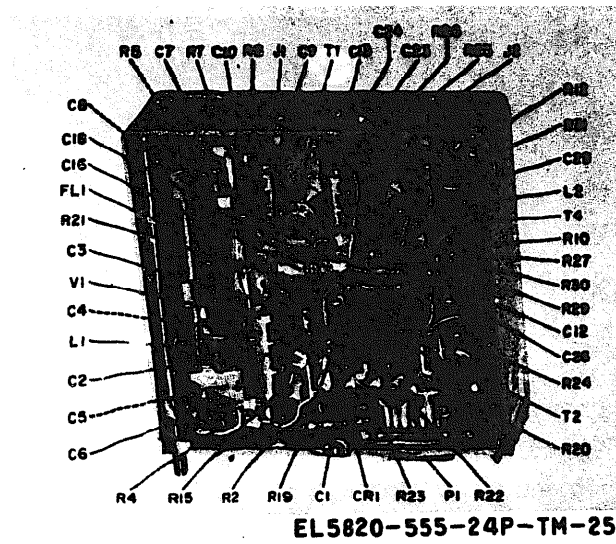

Figure 3-25. USB i-fla-f amplifier module, front view, cover removed (1A5A4).

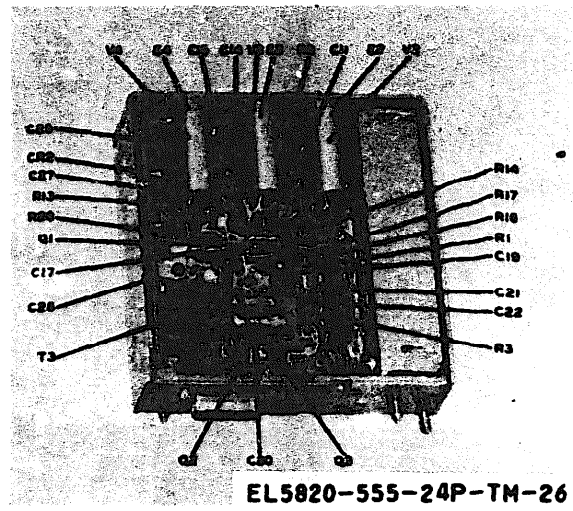

Figure 3-26. USB i-fla-f amplifier module, rear view, cover removed (1A5A4).

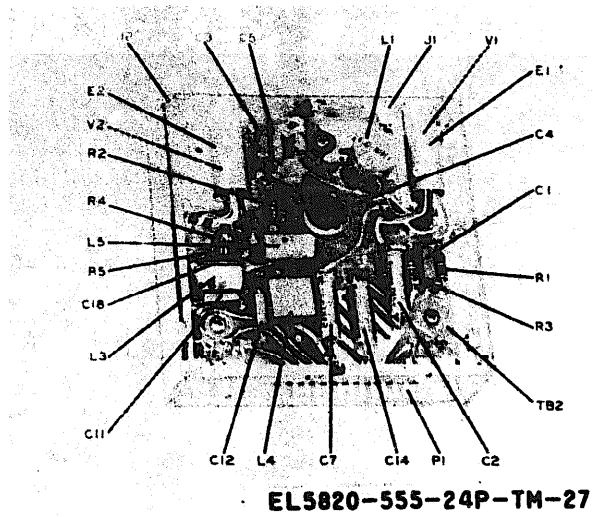

Figure 3-27. Carrier generator module, front view, cover removed (1A5A2).

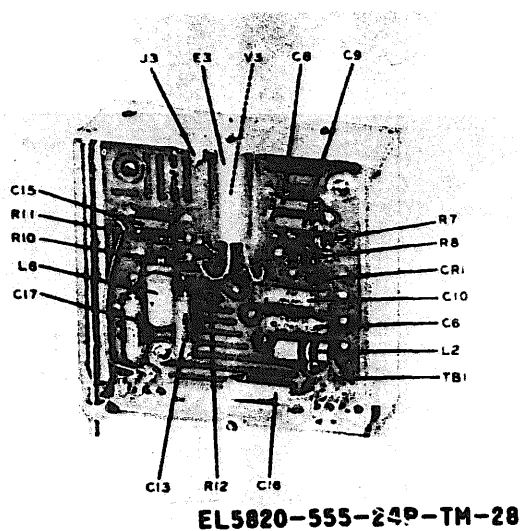

Figure 3-28. Carrier generator module, front view, cover removed (1A5A2).



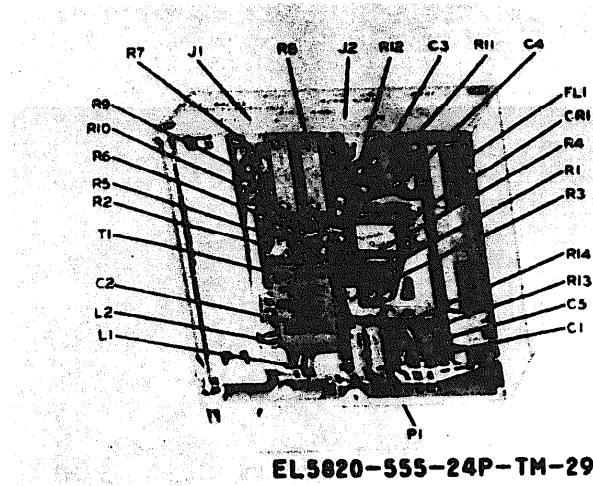

Figure 3-29. Balanced modulator module, usb modulator assembly, cover removed (1A5ASA1).

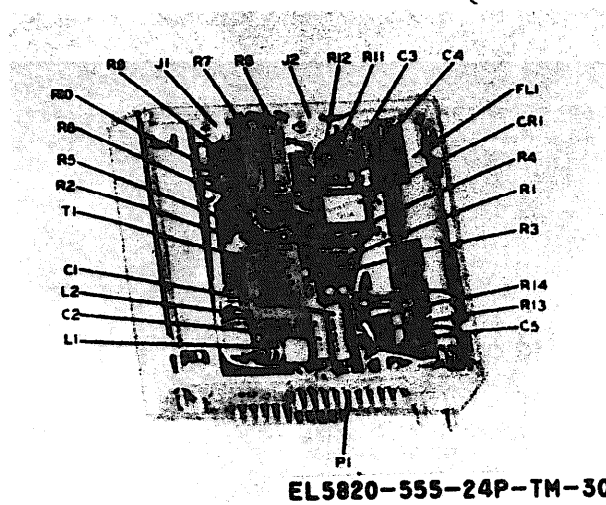

Figure 3-30. Balanced modulator module, Isb modulator assembly, cover removed (1A5ASA2).

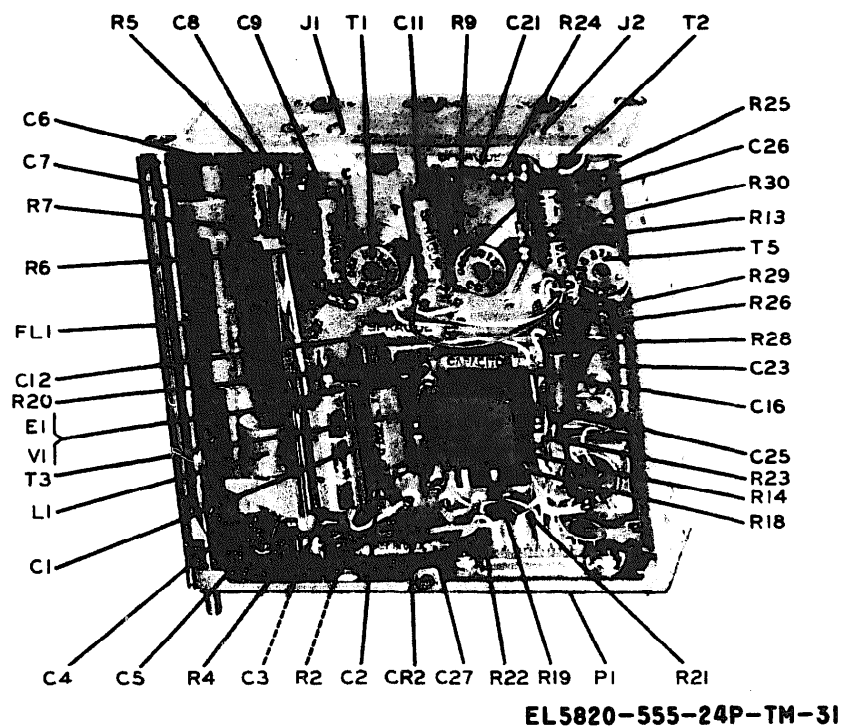

Figure 3-31. AM i-fla-f amplifier module, front view, cover removed (1A5A6).

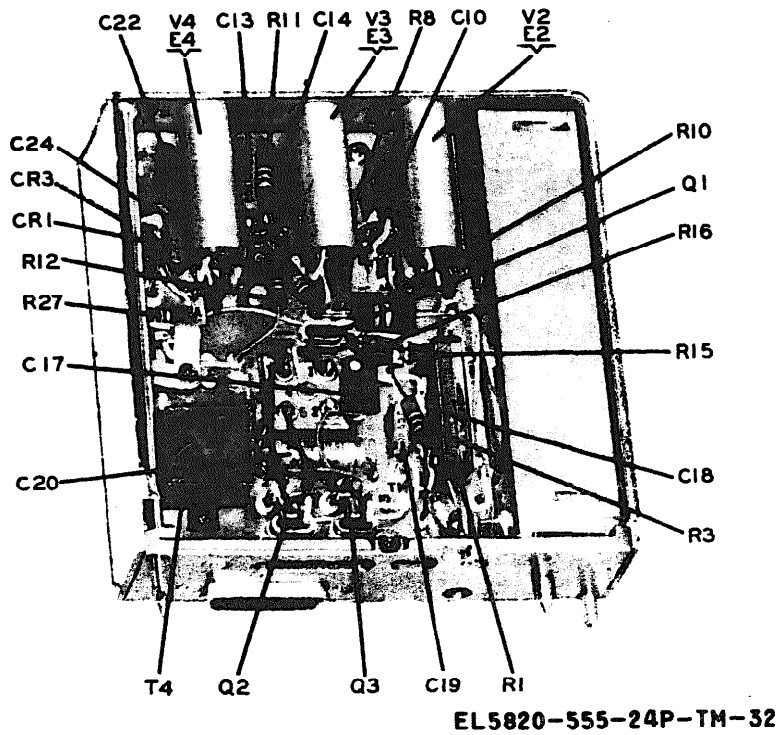
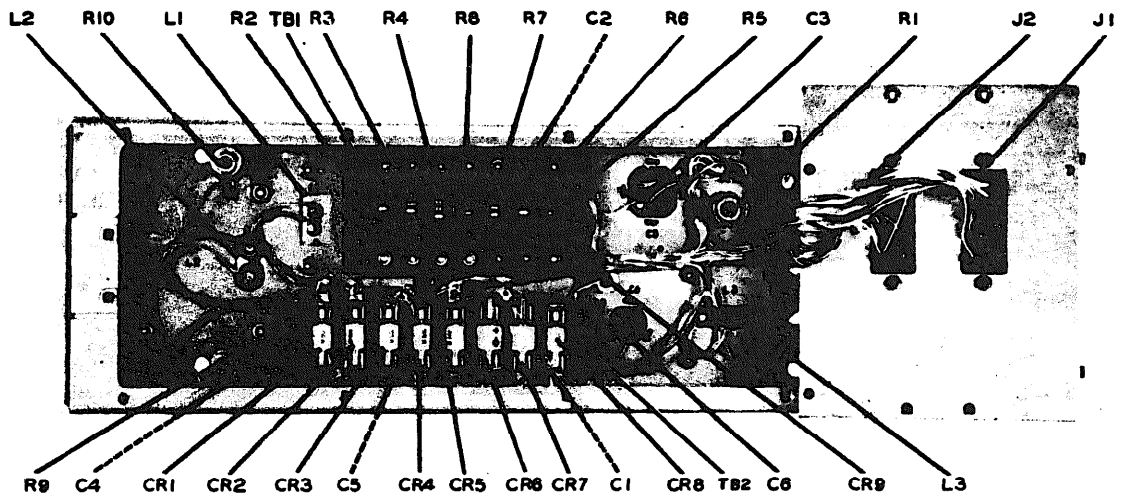

Figure 3-32. AM i-fla-f amplifier module, rear view, cover removed (1A5A6).



EL5820-555-24P-TM-34

Figure 3-33. Low-Voltage Power Supply PP-2154/U, front view, cover removed (1A10).

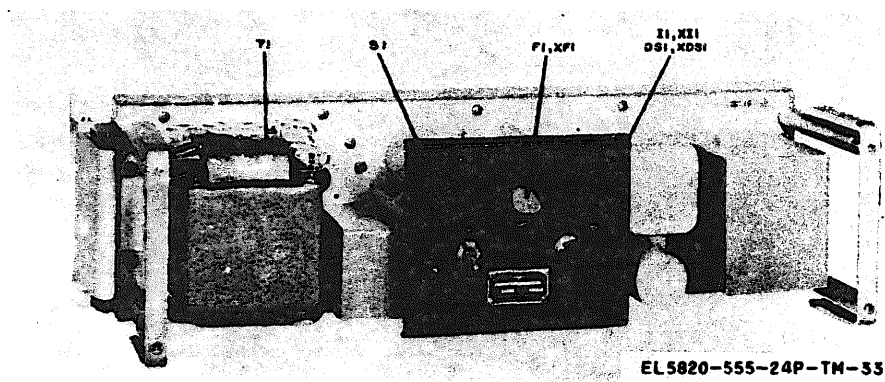

Figure 3-34. Low-Voltage Power Supply PP-2154/U, rear view, cover removed (1A10).

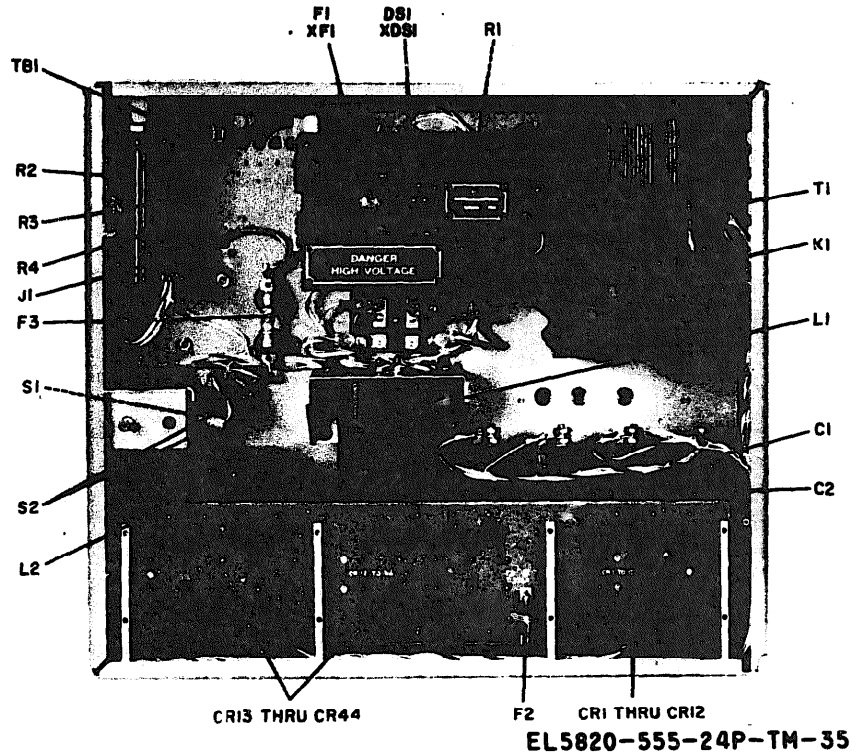

Figure 3-35. High-Voltage Power Supply PP-2153/U, front view, cover removed (1A12).

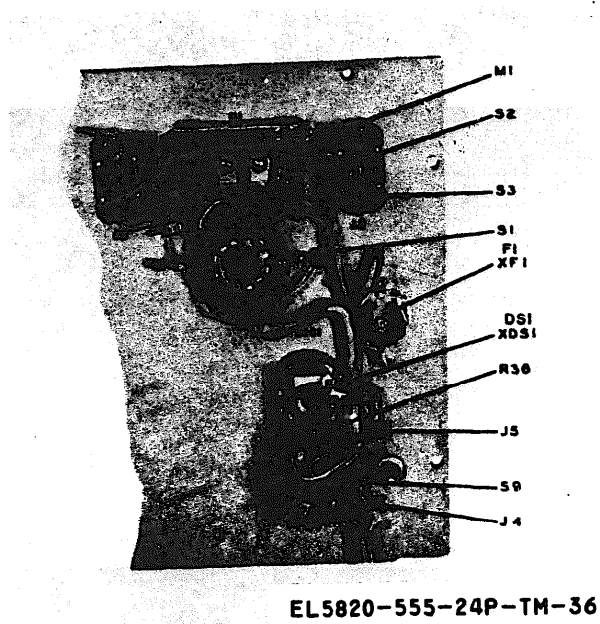
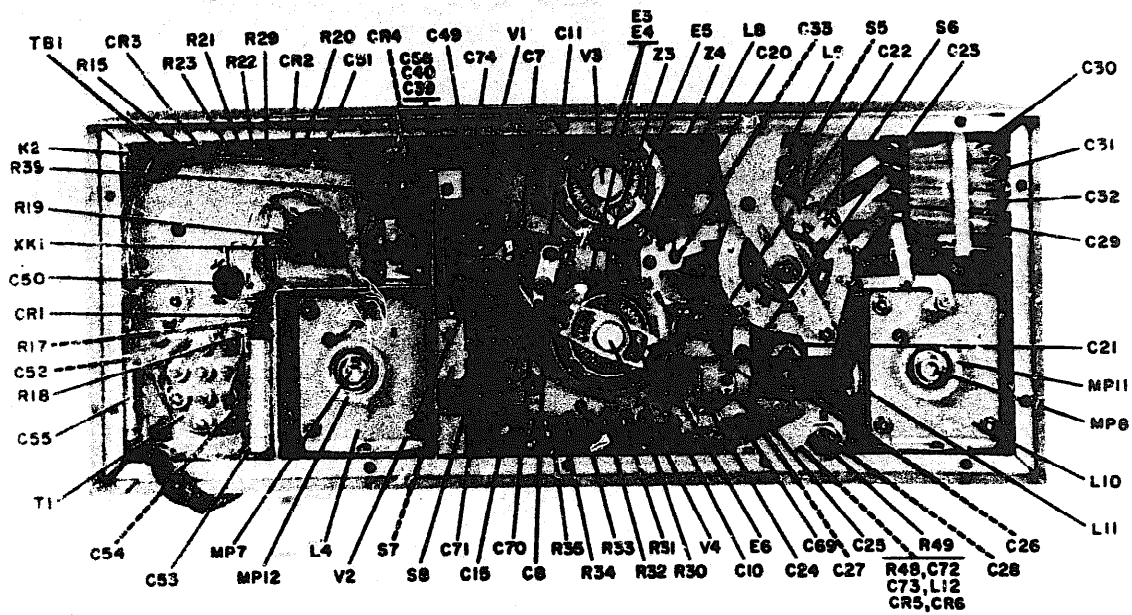

Figure 3-36. Power Amplifier 367A-3, front panel, rear view (1A3).





EL5820-555-24P-TM-37

Figure 3-37. Power Amplifier 367A-3, front view, front panel removed (1A3).

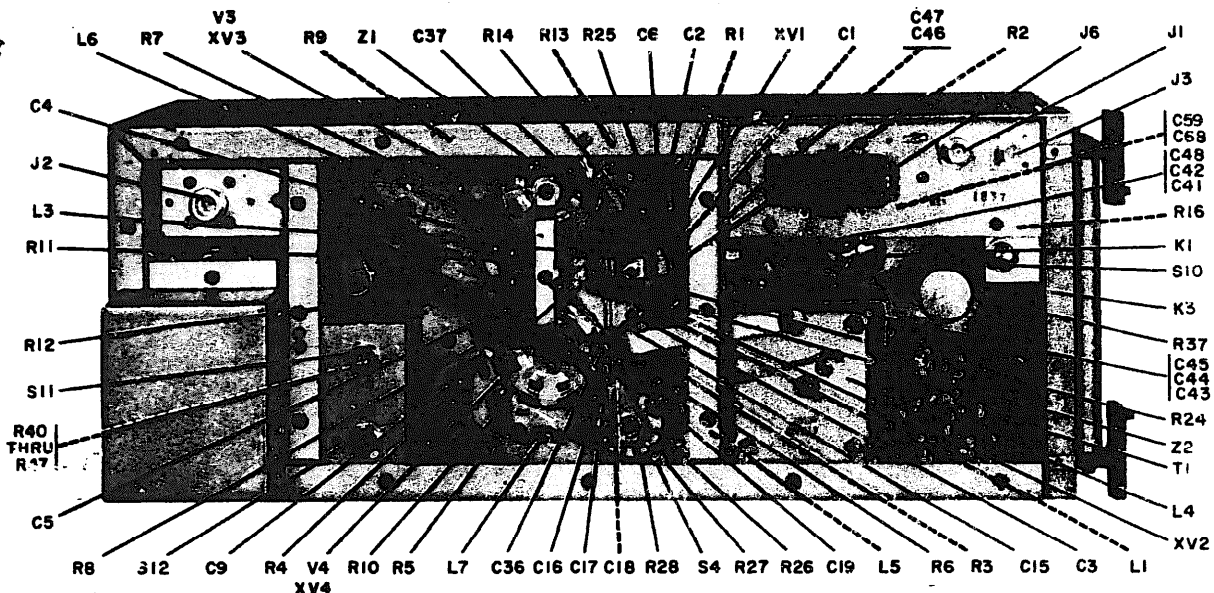

EL5820-555-24P-TM-38

Figure 3-38. Power Amplifier 367A-3, rear view, cover removed (1A3).

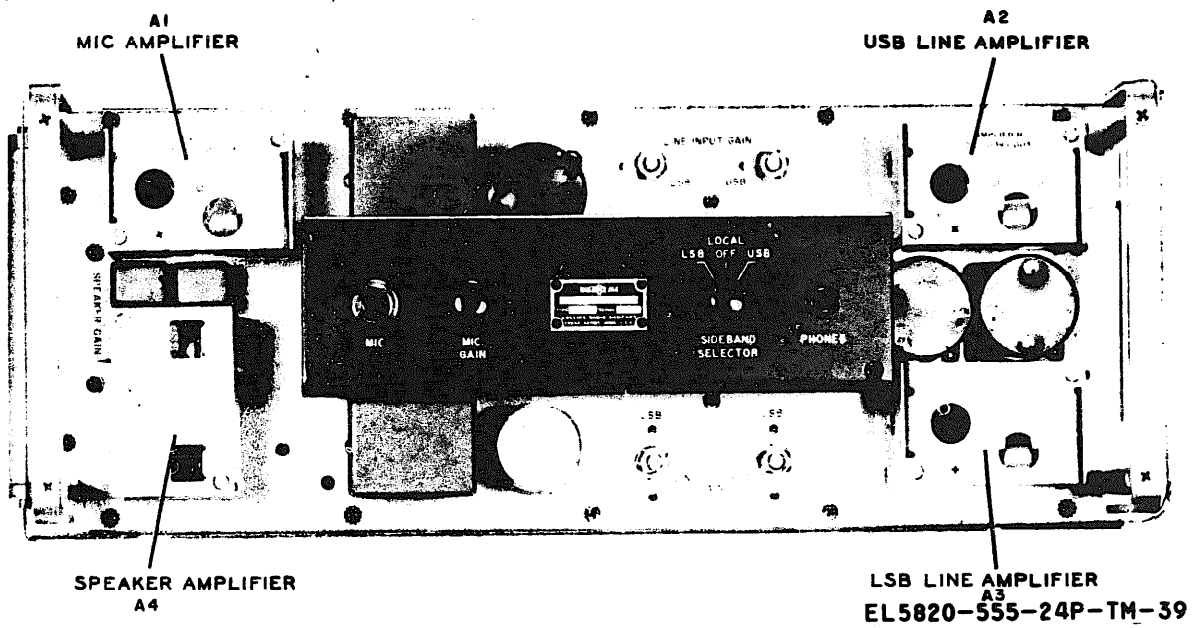
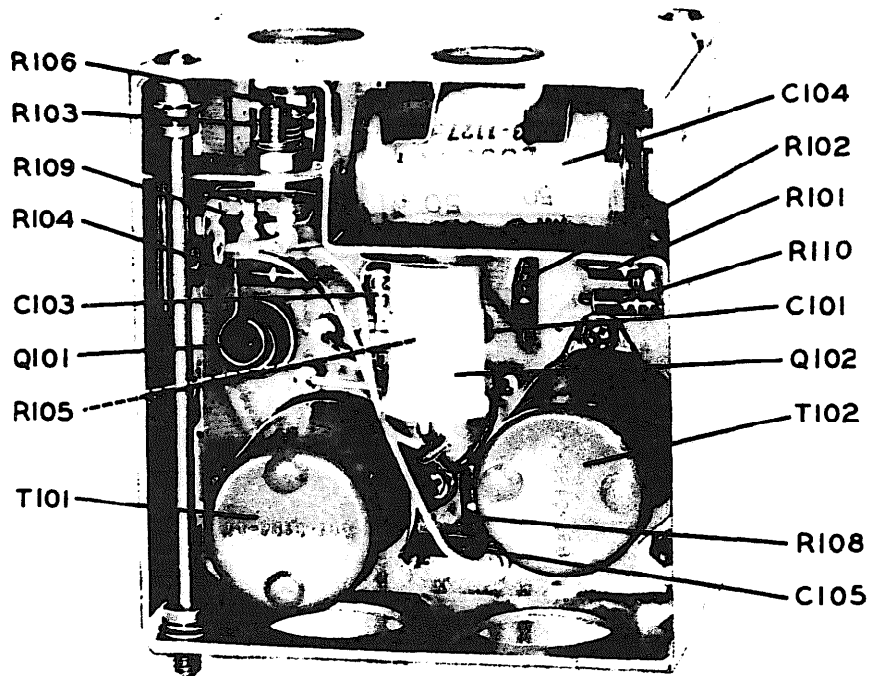

Figure 3-39. Audio and Control Unit 159B-1, module location (1A7).



**EL5820-555-24P-TM-40**

Figure 3-40. Mike or line amplifier module, component side (1A7A1, 1A7A2, and 1A7A3).

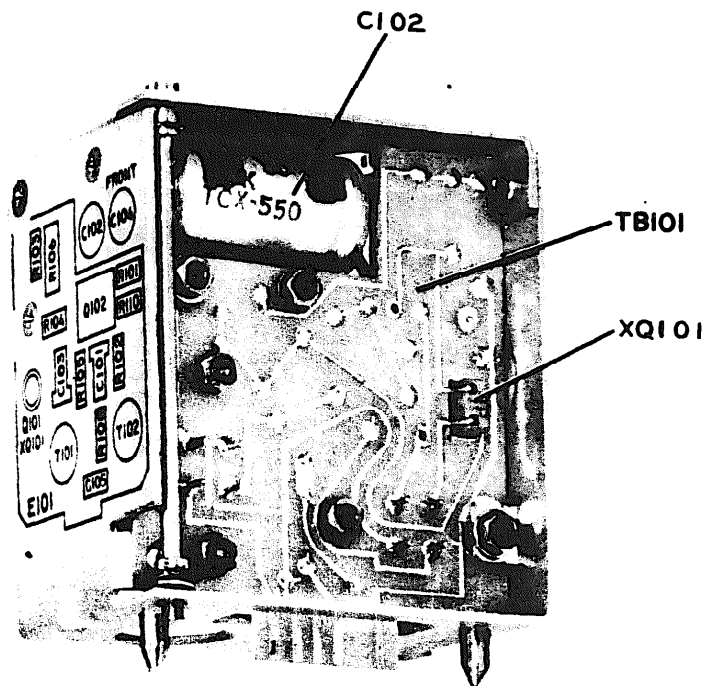

Figure 3-41. Mike or line amplifier module, wiring side (1A7A1, 1A7A2, and 1A7A3).

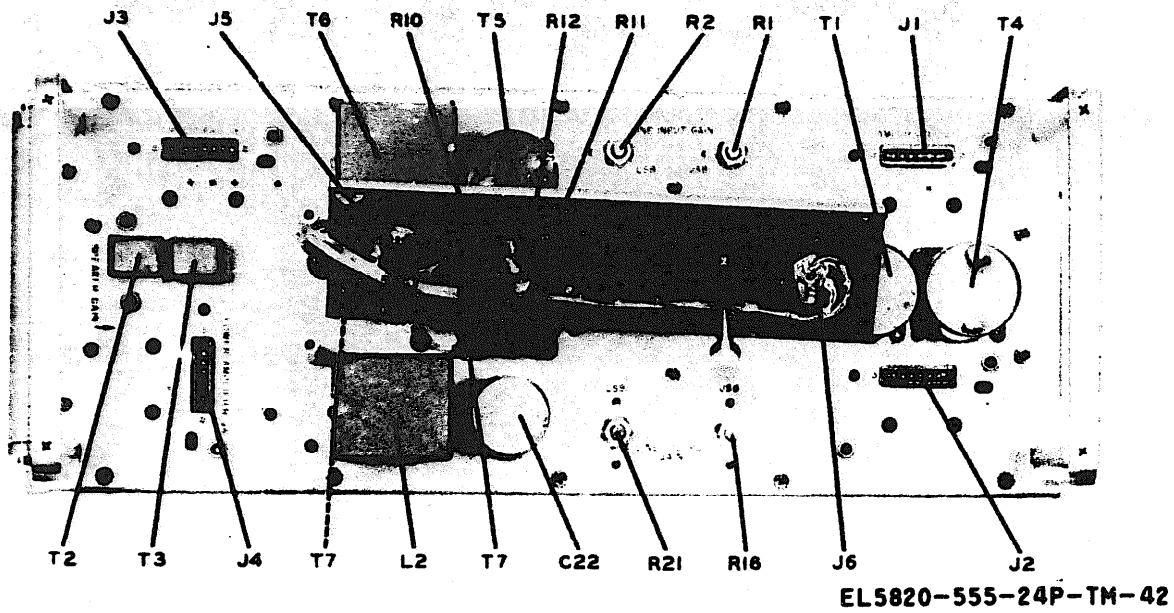
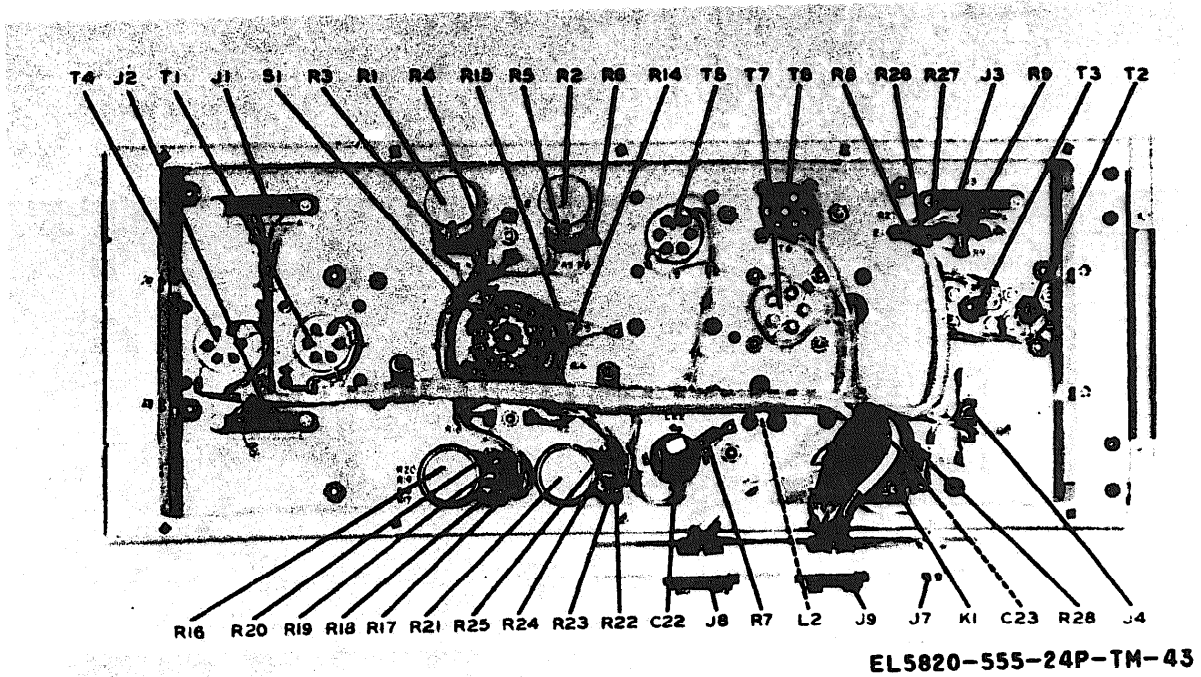
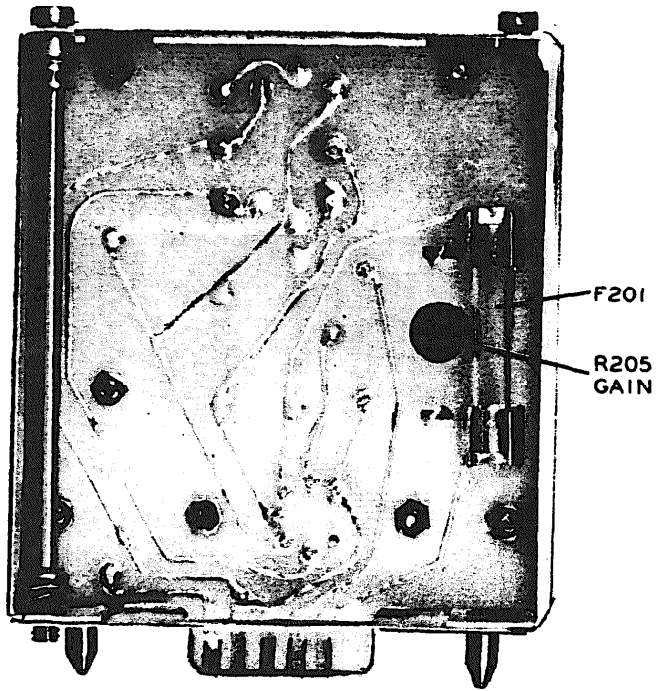

Figure 3-42. Audio and Control Unit 159B-1 chassis, front view (1A7).



EL5820-555-24P-TM-43

Figure 3-43. Audio and Control Unit 159B-1 chassis, rear view (1A7).



**EL5820-555-24P-TM-44**

Figure 3-44. Speaker amplifier module, wiring side  
(1A7A4).



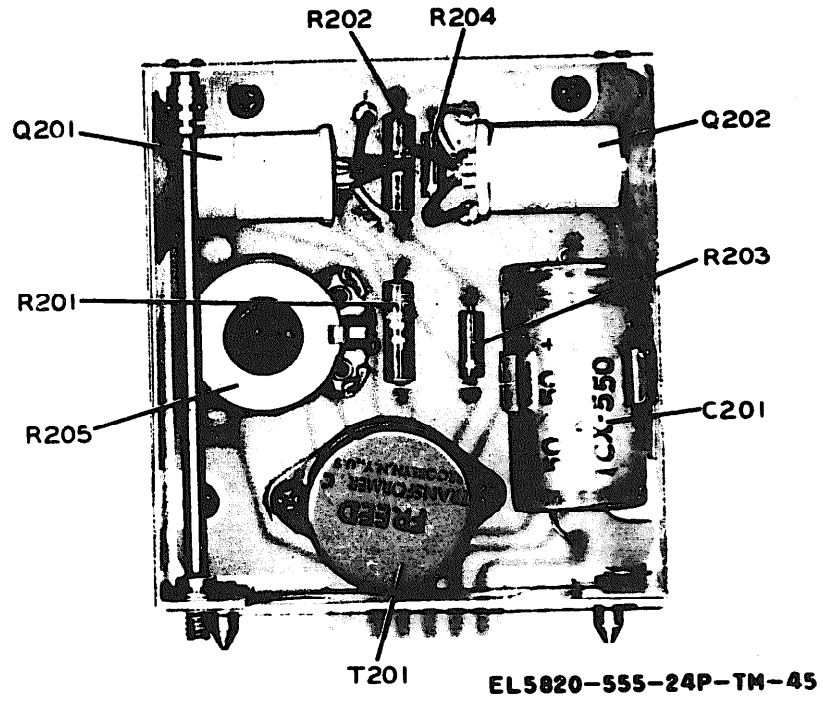
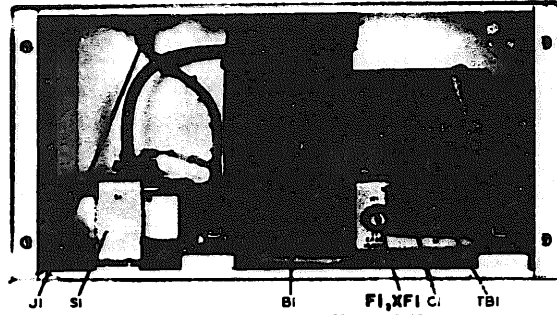
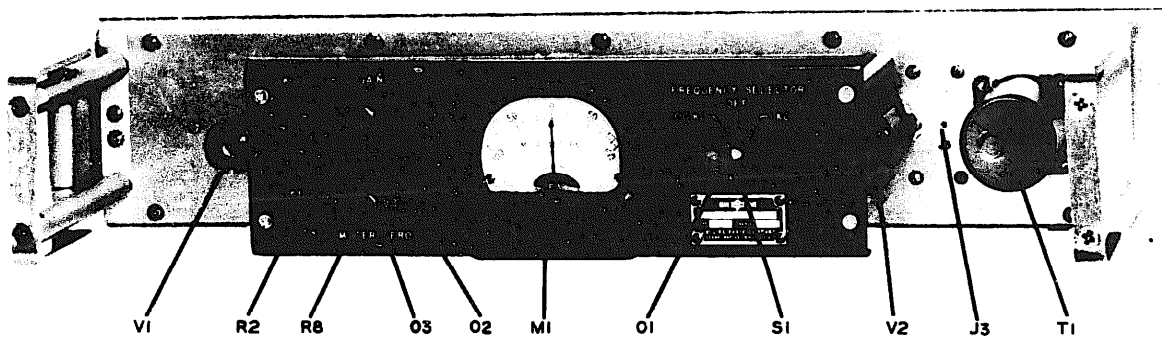

Figure 3-45. Speaker amplifier module, component side (1A7A7).



**EL5820-555-24P-TM-46**

Figure 3-46. Blower HD-347/U, front cover and filter removed (1A11).



**EL5820-555-24P-TM-47**

Figure 3-47. Frequency Comparator CM-126/UR, front view, cover removed (1A8).

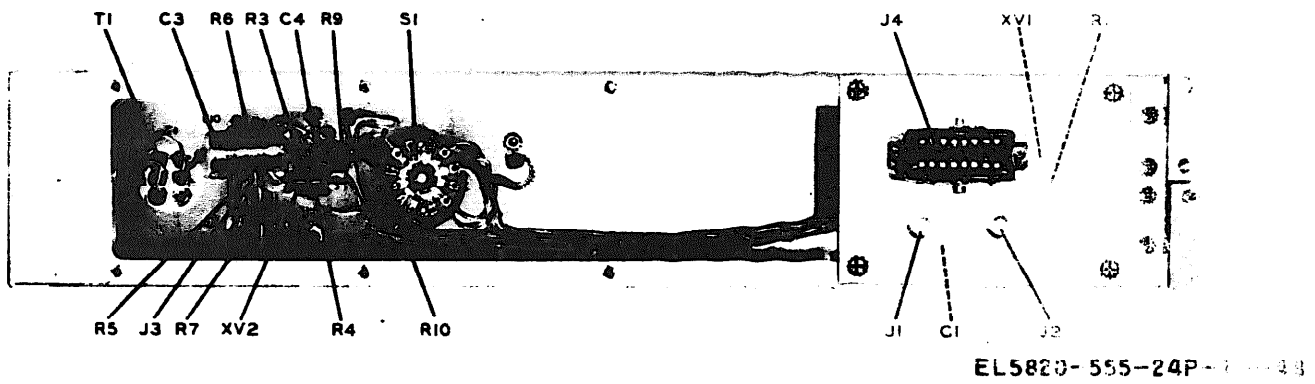
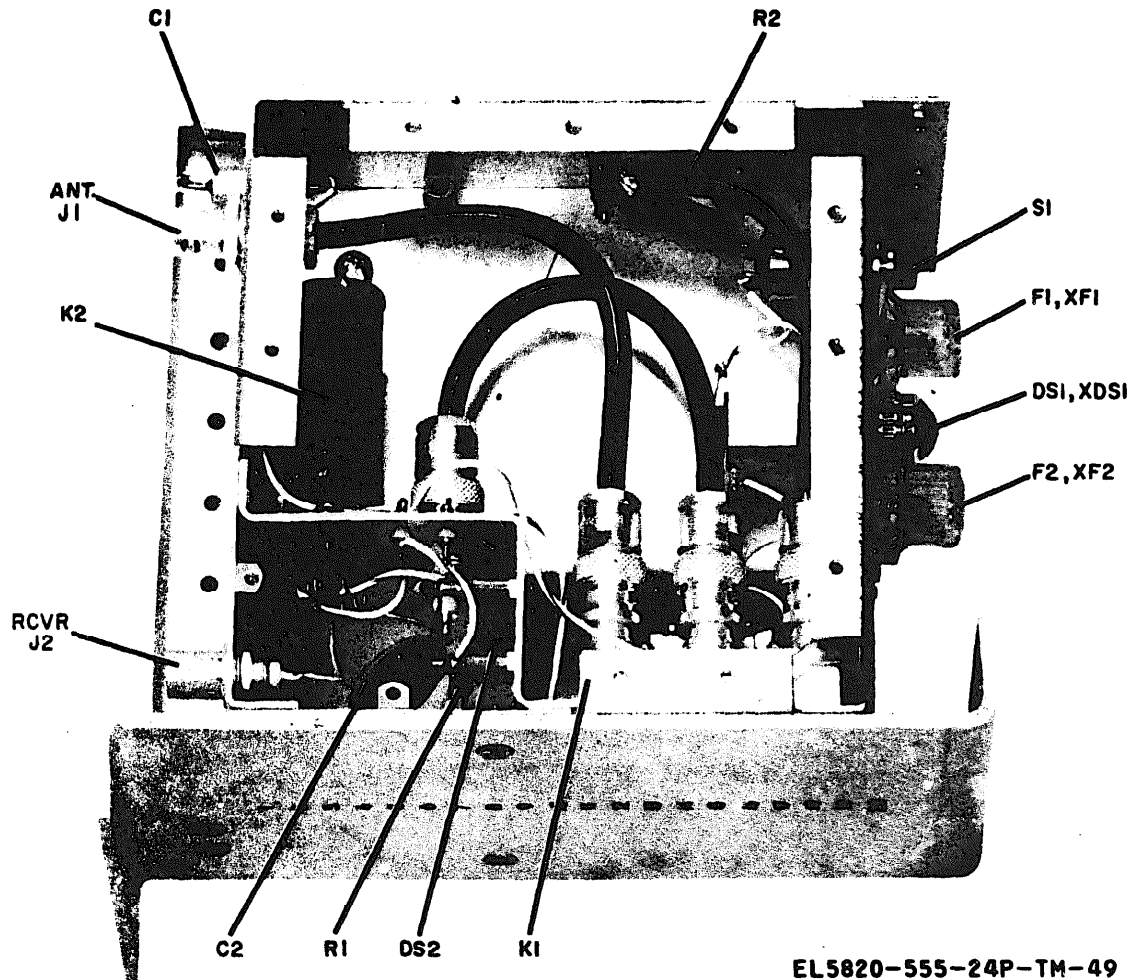

Figure 3-48. Frequency Comparator CM-126/UR, rear view, cover removed (1A8).



EL5820-555-24P-TM-49

Figure 3-49. Thermal relay input portector, bottom view, cover removed (1A1).

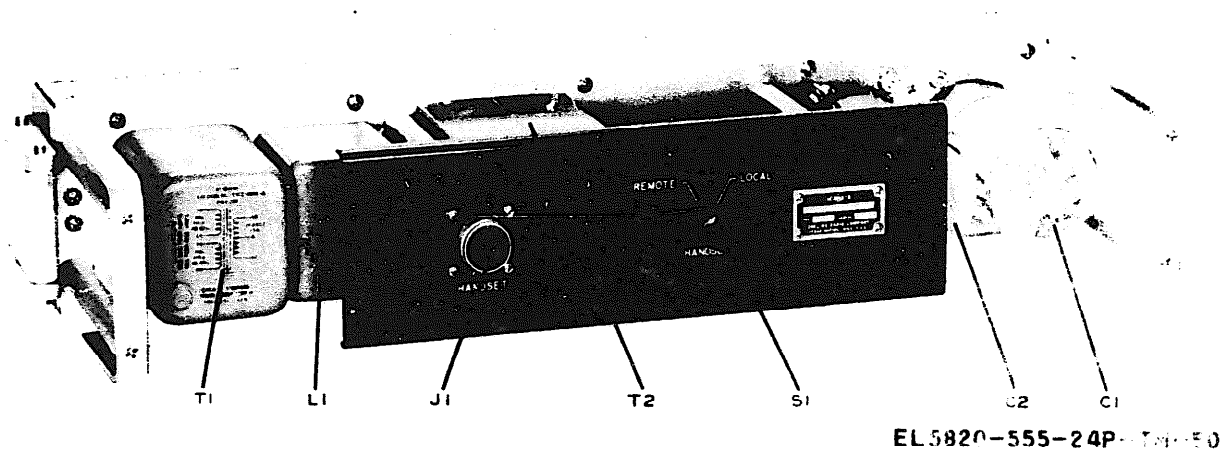

Figure 3-50. Handset adapter, front view, cover removed (1A9).

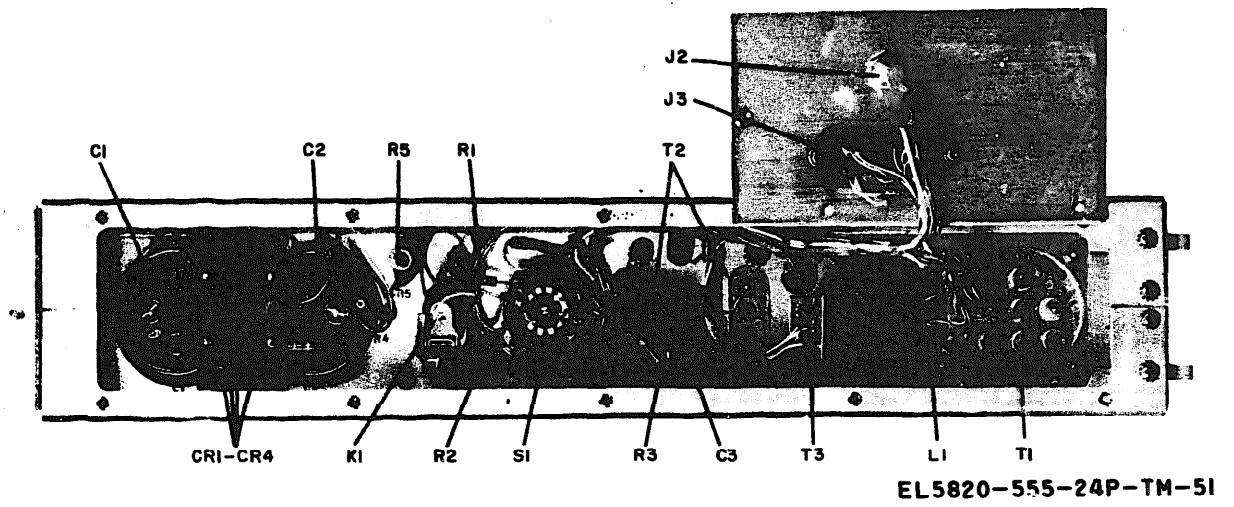
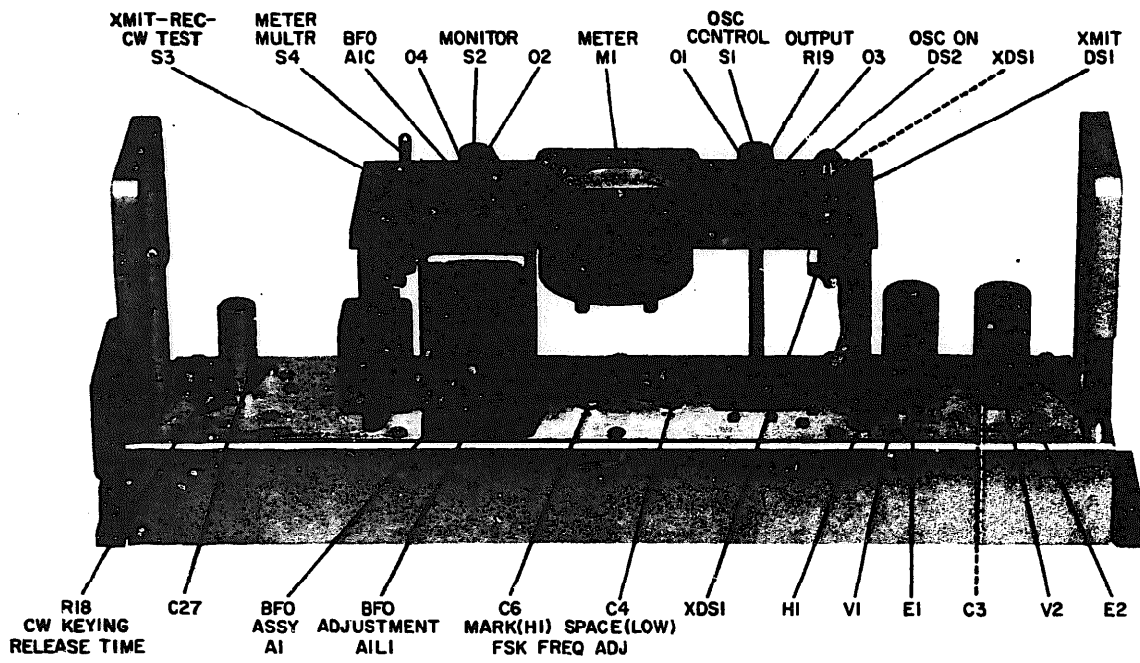

Figure 3-51. Handset adapter, rear view, cover removed (1A9).



**EL5820-555-24P-TM-52**

Figure 3-52. CW and fsk unit, front view, cover removed (1A6).



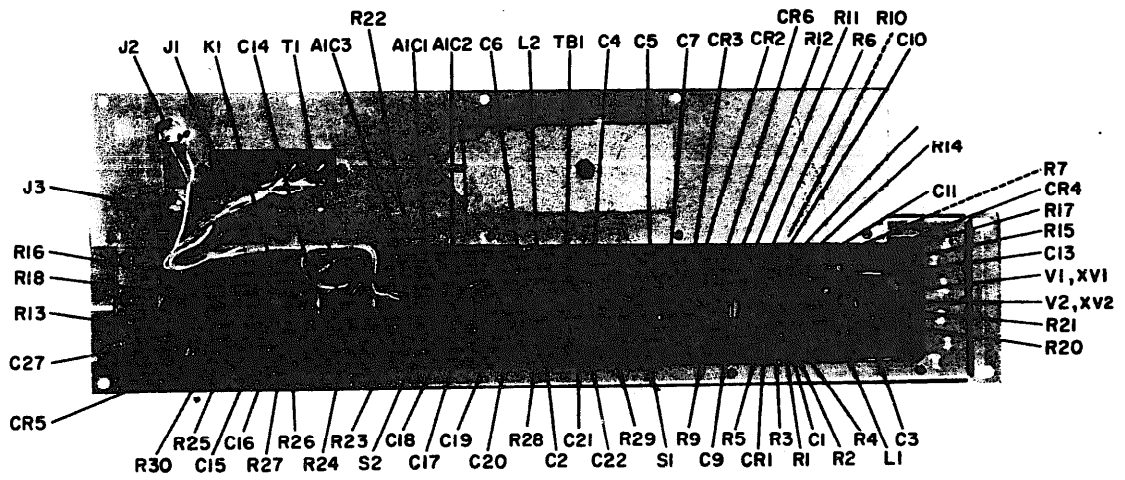

EL5820-555-24P-TM-53

Figure 3-53. CW and fsk unit, rear view, cover removed (1A6).

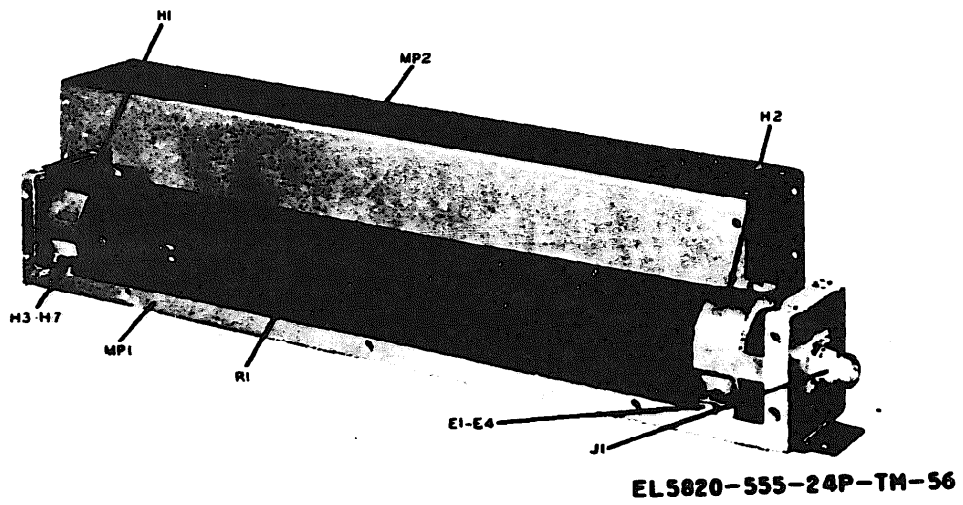

Figure 3-54. BFO subassembly (1A6A1).

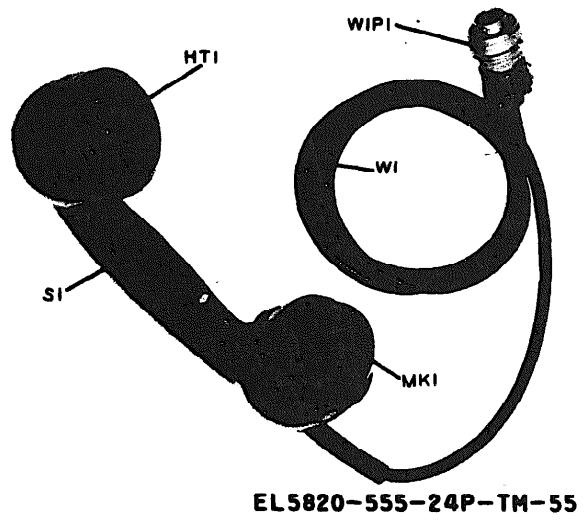
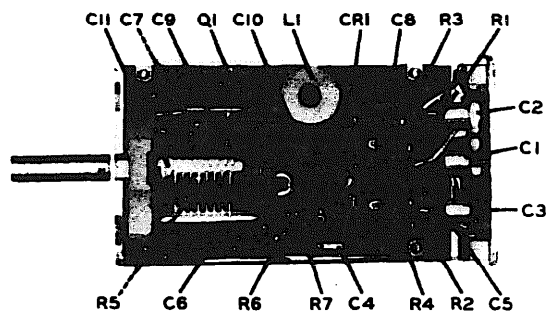

Figure 3-55. Dynamic handset (1A13A3).



**EL5820-555-24P-TM-54**

Figure 3-56. Dummy Antenna 172J-1, cover removed (1A14).

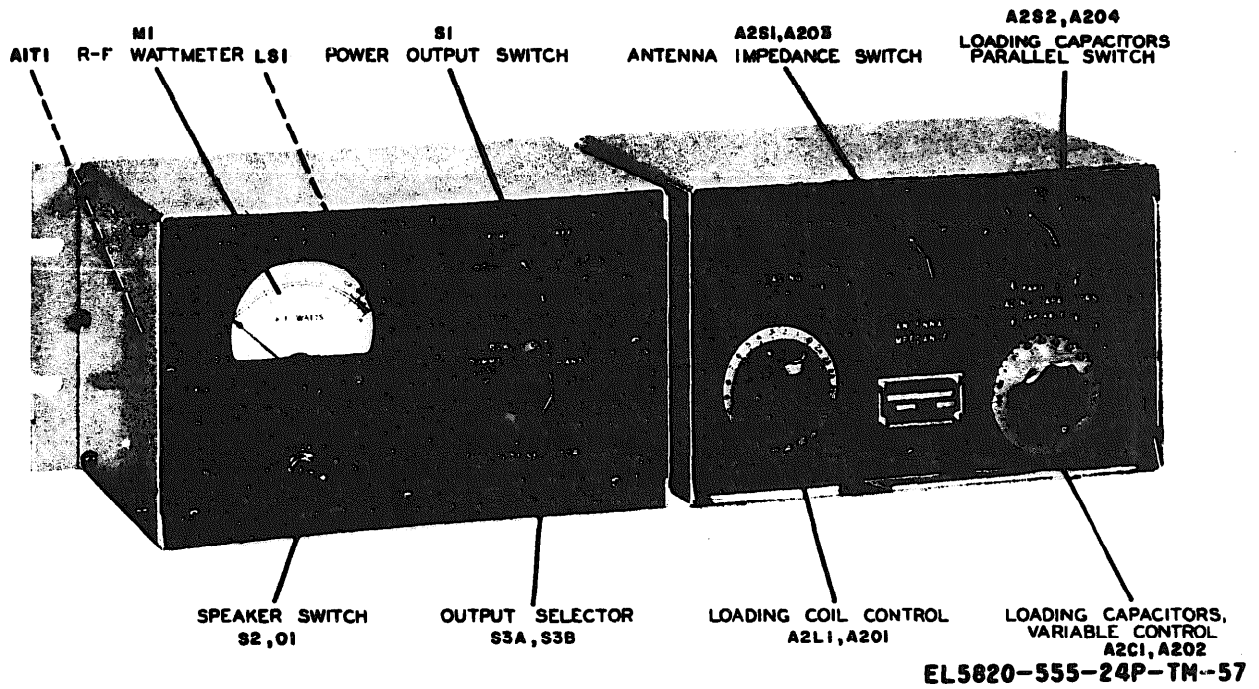

Figure 3-57. Antenna Network 180U-2, operating controls (1A2).

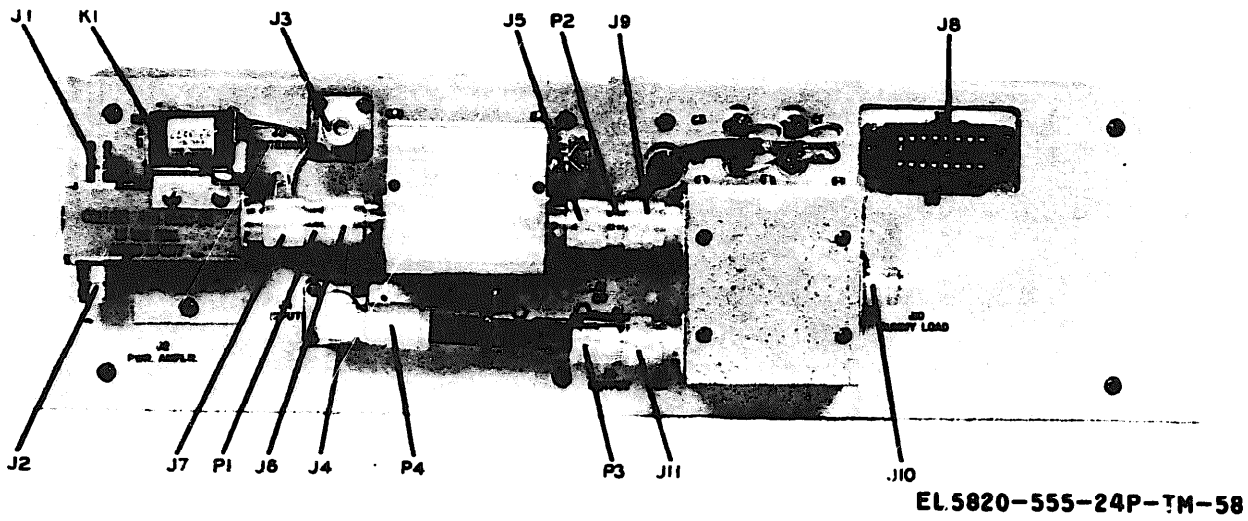

Figure 3-58. Antenna Network 180U-2, input and output connectors (1A2).

SECTION IV INDEX-FEDERAL STOCK NUMBER AND REFERENCE NUMBER CROSS REFERENCE  
TO FIGURE AND ITEM NUMBER OR REFERENCE DESIGNATION

FEDERAL STOCK NUMBER	FIGURE NUMBER	ITEM NUMBER OR REF. DESIGNATION	FEDERAL STOCK NUMBER	FIGURE NUMBER	ITEM NUMBER OR REF. DESIGNATION
1430-956-4907	3-3	1A4MP28	5355-079-9556		1A5A701
1430-956-4907	3-3	1A4MP34	5355-079-9556	3-52	1A601
1430-956-4907	3-6	1A4A3MP27	5355-079-9556	3-52	1A602
1430-956-4907	3-6	1A4A3MP28	5355-079-9556	3-52	1A603
3010-289-8593	3-37	1A3MP11	5355-668-5311		1A5A704
3010-788-5145	3-3	1A4A4MP36	5355-668-5311		1A5A705
3020-580-3850	3-16	1A4A4MP5	5355-668-5311		1A702
3020-580-3850	3-16	1A4A4MP6	5355-668-5311	3-47	1A802
3020-676-2832	3-6	1A4A3MP1	5355-668-5311	3-47	1A803
3020-676-2836	3-6	1A4A3MP5	5355-68-5311	3-52	1A604
3020-676-2838	3-6	1A4A3MP6	5355-679-9325		1A3DS5
3020-684-2152	3-16	1A4A4MP1	5355-679-9325		1A3DS6
3020-684-2152	3-16	1A4A4MP2	5355-679-9326		1A3DS7
3020-684-2152	3-16	1A4A4MP3	5355-679-9326		1A3DS8
3020-684-2152	3-16	1A4A4MP4	5355-814-4340		1A301
3020-787-8291	3-3	1A4MP27	5355-814-4340	3-57	1A2A201
3020-794-2033	3-3	1A4MP60	5355-814-6639	3-57	1A2A202
3110-447-4775	3-6	1A4A3MP8	5355-817-5564	3-3	1A401
3110-447-4775	3-6	1A4A3MP19	5355-821-5824	3-3	1A402
3120-725-3851	3-3	1A4MP3			
3120-725-3852	3-3	1A4MP2	5395-666-4508	3-42	1A7J1
3120-725-3852	3-3	1A4MP4	5395-666-4508	3-42	1A7J2
3120-725-3852	3-3	1A4MP11	5395-666-4508	3-42	1A7J3
4140-856-0533	3-46	1A11B1	5395-666-4508	3-42	1A7J4
5305-054-6654		1A13A2H2	5820-023-3671		1A4A3A8
5305-071-1316		1A13H5	5820-44-8787		1A4A3A2
5305-579-3513		1A13A1H2	5820-447-9919	3-14	1A4A4S15
5305-719-5021		1A13H6	5820-537-4835	3-3	1A4MP15
5305-764-0076		1A13A2H4	5820-537-4835	3-3	1A4MP16
5310-275-0586		1A13H1	5820-537-4835	3-3	1A4MP50
5340-598-0496		1A13A2H1	5820-537-4835	3-3	1A4MP51

SECTION IV INDEX-FEDERAL STOCK NUMBER AND REFERENCE NUMBER CROSS REFERENCE  
TO FIGURE AND ITEM NUMBER OR REFERENCE DESIGNATION (CONTINUED)

FEDERAL STOCK NUMBER	FIGURE NUMBER	ITEM NUMBER OR REF. DESIGNATION	FEDERAL STOCK NUMBER	FIGURE NUMBER	ITEM NUMBER OR REF. DESIGNATION
5820-537-4835	3-3	1A4MP56	5820-794-2035	3-3	1A4MP63
5820-537-4835	3-3	1A4MP57	5820-794-2035	3-3	1A4MP64
5820-537-4835	3-3	1A4MP58	5820-794-2036	3-3	1A4MP66
5820-537-4835	3-3	1A4MP59	5820-794-2050	3-3	1A4MP61
5820-537-4835	3-3	1A4MP80	5820-794-2050	3-3	1A4MP62
5820-537-4835	3-3	1A4MP81	5820-795-9331	3-3	1A4MP8
5820-672-6312	3-4	1A4A1	5820-811-7677	3-37	1A3TB1
5820-675-4625	3-16	1A4AAMP10	5820-811-9814	3-34	1A10TB2
5820-678-5082		1A4A2Z2	5820-812-1968	3-3	1A4MP38
5820-678-5083		1A4A2Z3	5820-812-1968	3-3	1A4MP69
5820-678-5322		1A5A2Z1	5820-812-1968	3-3	1A4MP70
5820-678-5323		1A5A2Z2	5820-813-0738	3-35	1A12TB2
5820-678-5481		1A7A1Z101	5820-813-0739		1A5A7TB1
5820-679-9386		1A4A3A5	5820-813-3433	3-3	1A4AAMP37
5820-679-9387		1A4A3A6	5820-822-9738	3-16	1A4A4Z2
5820-679-9427	3-16	1A4A4Z8	5820-822-9739	3-16	1A4A4Z3
5820-679-9440	3-16	1A4A4Z22	5820-822-9740	3-16	1A4A4Z4
5820-683-4434	3-16	1A4A4Z20	5820-822-9741	3-16	1A4A4Z5
5820-683-4435	3-16	1A4A4Z19	5820-822-9742	3-16	1A4A4Z6
5820-683-4436	3-16	1A4A4Z18	5820-822-9743	3-16	1A4A4Z14
5820-771-0951	3-6	1A4A3Z3	5820-822-9745	3-16	1A4A4Z21
5820-771-0952	3-9	1A4A3A7	5820-822-9746	3-16	1A4A4Z25
5820-787-3482		1A3MP1	5820-822-9747	3-16	1A4A4Z26
5820-787-3482		1A3MP2	5820-822-9748	3-16	1A4A4Z1
5820-787-6029	3-3	1A4MP68	5820-822-9749	3-16	1A4A4Z30
5820-787-6034	3-3	1A4MP12	5820-868-1283		1A4A3A2TB1
5820-787-8286		1A3MP6	5820-987-3554		1A4A3A3
5820-787-8292	3-3	1A4MP33	5821-615-4985	3-14	1A4A4S2
5820-788-2634	3-3	1A4MP23	5821-615-4987	3-14	1A4A4S14
5820-788-2637	3-3	1A4MP30	5821-676-2834	3-6	1A4A3MP12
5820-794-2034	3-3	1A4MP48	5821-676-2837	3-6	1A4A3MP22



SECTION IV INDEX-FEDERAL STOCK NUMBER AND REFERENCE NUMBER CROSS REFERENCE

TO FIGURE AND ITEM NUMBER OR REFERENCE DESIGNATION (CONTINUED)

FEDERAL STOCK NUMBER	FIGURE NUMBER	ITEM NUMBER OR REF. DESIGNATION	FEDERAL STOCK NUMBER	FIGURE NUMBER	ITEM NUMBER OR REF. DESIGNATION
5821-679-9372	3-6	1A4A3Z1	5905-060-2481	3-48	1A8R5
5821-679-9375	3-6	1A4A3Z4	5905-060-2484	3-5	1A4A1R4
5821-679-9376	3-6	1A4A3Z5	5905-060-2484	3-5	1A4A1R9
5821-679-9426	3-16	1A4A4Z7	5905-060-2484	3-5	1A4A1R13
5821-679-9428	3-16	1A4A4Z9	5905-061-2120	3-10	1A4A3A2R4
5821-679-9429	3-16	1A4A4Z10	5905-062-0537	3-38	1A3R27
5821-679-9430	3-16	1A4A4Z11	5905-062-5039		1A2A1R5
5821-679-9431	3-16	1A4A4Z12	5905-062-5039		1A2A1R6
5821-679-9432	3-16	1A4A4Z13	5905-063-8405	3-20	1A5A7R11
5821-679-9435	3-16	1A4A4Z16	5905-064-0555		1A2A1R3
5821-679-9436	3-16	1A4A4Z17	5905-064-0555		1A2A1R4
5821-679-9441	3-16	1A4A4Z23	5905-064-0555	3-10	1A4A3A2R5
5821-679-9442	3-16	1A4A4Z24	5905-064-0555	3-48	1A8R6
5821-679-9442	3-16	1A4A4Z27	5905-068-0066		1A2A1R3
5821-679-9446	3-16	1A4A4Z28	5905-068-0066		1A2A1R4
5821-679-9447	3-16	1A4A4Z29	5905-068-0066	3-53	1A6R23
5821-708-6115	3-37	1A3E3	5905-068-5179		1A2A1R3
5821-708-6115	3-37	1A3E4	5905-068-5179		1A2A1R4
5821-729-5479	3-6	1A4A3Z2	5905-073-2240	3-56	1A14R1
5821-810-2607		1A4A3A1	5905-079-6536	3-53	1A6R24
5840-938-8301	3-53	1A6TB1	5905-081-6137	3-17	1A4A5R6
5905-023-9089	3-20	1A5A7R4	5905-081-6381		1A2A1R3
5905-030-2755	3-37	1A3R49	5905-081-6381		1A2A1R4
5905-044-5507	3-5	1A4A1R5	5905-081-6381	3-11	1A4A3A8R7
5905-051-5557		1A2A1R3	5905-087-4202		1A2A1R3
5905-051-5557		1A2A1R4	5905-087-4202		1A2A1R4
5905-056-9270		1A2A1R3	5905-087-7166	3-53	1A6R22
5905-056-9270		1A2A1R4	5905-088-0635	3-38	1A3R40
5905-060-0524	3-49	1A1R2	5905-088-0635	3-38	1A3R41
5905-060-2481		1A2A1R3	5905-088-0635	3-38	1A3R42
5905-060-2481		1A2A1R4	5905-088-0635	3-38	1A3R43

SECTION IV INDEX-FEDERAL STOCK NUMBER AND REFERENCE NUMBER CROSS REFERENCE  
 TO FIGURE AND ITEM NUMBER OR REFERENCE DESIGNATION (CONTINUED)

FEDERAL STOCK NUMBER	FIGURE NUMBER	ITEM NUMBER OR REF. DESIGNATION	FEDERAL STOCK NUMBER	FIGURE NUMBER	ITEM NUMBER OR REF. DESIGNATION
5905-088-0635	3-38	1A3R44	5905-106-1282	3-31	1A5A6R5
5905-088-0635	3-38	1A3R45	5905-106-1282	3-53	1A6R7
5905-088-0635	3-38	1A3R46	5905-106-3491	3-27	1A5A2R2
5905-088-0635	3-38	1A3R47	5905-106-9344	3-6	1A4A3R3
5905-088-3100		1A2A1R3	5905-106-9344	3-10	1A4A3A2R24
5905-088-3100		1A2A1R4	5905-106-9344	3-17	1A4A5R2
5905-088-3101	3-9	1A4A3A7R11	5905-106-9344	3-23	1A5A5R21
5905-102-2740	3-6	1A4A3R23	5905-106-9344	3-25	1A5A4R21
5905-104-5755	3-10	1A4A3A2R24	5905-106-9344	3-29	1A5A3A1R1
5905-104-5755	3-14	1A4A4R57	5905-106-9344	3-29	1A5A3A1R2
5905-104-8339	3-27	1A5A2R3	5905-106-9344	3-30	1A5A3A2R1
5905-104-8348	3-14	1A4A4R58	5905-106-9344	3-30	1A5A3A2R2
5905-106-1245	3-43	1A7R7	5905-106-9344	3-31	1A5A6R20
5905-106-1273	3-2	1A4R5	5905-106-9344	3-37	1A3R17
5905-106-1273	3-6	1A4A3R4	5905-106-9344	3-38	1A3R13
5905-106-1273	3-6	1A4A3R22	5905-106-9344	3-38	1A3R24
5905-106-1273	3-6	1A4A3R29	5905-106-9344	3-40	1A7A1R108
5905-106-1273	3-7	1A4A3A3R11	5905-106-9345	3-12	1A4A2R3
5905-106-1273	3-9	1A4A3A7R14	5905-106-9345	3-12	1A4A2R11
5905-106-1273	3-12	1A4A2R12	5905-106-9345	3-12	1A4A2R15
5905-106-1273	3-27	1A5A2R2	5905-106-9645	3-31	1A5A6R29
5905-106-1273	3-28	1A5A2R7	5905-106-9345	3-32	1A5A6R11
5905-106-1273	3-28	1A5A2R10	5905-106-9345	3-37	1A3R22
5905-106-1282		1A4A3R33	5905-106-9345	3-54	1A6A1R1
5905-106-1282		1A4A3A6R17	5905-106-9347	3-14	1A4A4R60
5905-106-1282	3-8	1A4A3A6R12	5905-106-9348		1A5A4R32
5905-106-1282	3-14	1A4A4R55	5905-106-9348		1A5A5R32
5905-106-1282	3-25	1A5A4R2	5905-106-9348		1A5A6R32
5905-106-1282	3-25	1A5A4R5	5905-106-9348	3-12	1A4A2R15
5905-106-1282	3-27	1A5A2R4	5905-106-9348	3-14	1A4A4R35
5905-106-1282	3-31	1A5A6R2	5905-106-9348	3-24	1A5A5R16

SECTION IV INDEX-FEDERAL STOCK NUMBER AND REFERENCE NUMBER CROSS REFERENCE  
 TO FIGURE AND ITEM NUMBER OR REFERENCE DESIGNATION (CONTINUED)

FEDERAL STOCK NUMBER	FIGURE NUMBER	ITEM NUMBER OR REF. DESIGNATION	FEDERAL STOCK NUMBER	FIGURE NUMBER	ITEM NUMBER OR REF. DESIGNATION
5905-106-9348	3-26	1A5A4R16	5905-121-4953	3-12	1A4A2R15
5905-106-9348	3-32	1A5A6R15	5905-126-1701	3-53	1A6R30
5905-110-0310	3-17	1A4A5R28	5905-126-6691	3-6	1A4A3R20
5905-110-0943	3-27	1A5A2R2	5905-126-6691	3-53	1A6R21
5905-110-0993	3-8	1A4A3A6R5	5905-133-3081	3-23	1A5A5R4
5905-110-0993	3-53	1A6R25	5905-133-0381	3-23	1A5A5R7
5905-111-4742	3-23	1A5A5R31	5905-133-0381	3-23	1A5A5R29
5905-111-4742	3-25	1A5A4R31	5905-133-0381	3-25	1A5A4R4
5905-111-4742	3-21	1A5A6R30	5905-133-0381	3-25	1A5A4R7
5905-111-4742	3-43	1A7R8	5905-133-0381	3-25	1A5A4R29
5905-111-4742	3-43	1A7R9	5905-133-0381	3-31	1A5A6R4
5905-111-4742	3-53	1A6R4	5905-133-0381	3-31	1A5A6R7
5905-111-4742	3-53	1A6R15	5905-133-0381	3-31	1A5A6R28
5905-111-4746	3-27	1A5A2R2	5905-133-0381	3-32	1A5A6R10
5905-111-4753	3-27	1A5A2R2	5905-141-0591	3-6	1A4A3R6
5905-114-5343	3-9	1A4A3A7R6	5905-141-0591	3-6	1A4A3R10
5905-114-5359	3-27	1A5A2R2	5905-141-0591	3-6	1A4A3R28
5905-114-5388	3-23	1A5A5R22	5905-141-0591	3-6	1A4A3R31
5905-114-5388	3-23	1A5A5R23	5905-141-0591	3-7	1A4A3A3R5
5905-114-5388	3-25	1A5A4R22	5905-141-0591	3-7	1A4A3A3R9
5905-114-5388	3-25	1A5A4R23	5905-141-0591	3-8	1A4A3A6R14
5905-114-5388	3-31	1A5A6R21	5905-141-0591	3-9	1A4A3A7R9
5905-114-5388	3-31	1A5A6R22	5905-141-0591	3-10	1A4A3A2R7
5905-114-5416	3-9	1A4A3A7R12	5905-141-0591	3-12	1A4A2R7
5905-114-5416	3-37	1A3R39	5905-141-0591	3-14	1A4A4R3
5905-114-5416	3-53	1A6R10	5905-141-0591	3-14	1A4A4R8
5905-114-5430	3-27	1A5A2R2	5905-141-0591	3-14	1A4A4R10
5905-116-8555	3-54	1A6A1R7	5905-141-0591	3-14	1A4A4R23
			5905-141-0591	3-14	1A4A4R29
5905-116-8556	3-54	1A6A1R3	5905-141-0591	3-14	1A4A4R31
5905-116-8569	3-27	1A5A2R2	5905-141-0591	3-14	1A4A4R36

SECTION IV INDEX-FEDERAL STOCK NUMBER AND REFERENCE NUMBER CROSS REFERENCE  
 TO FIGURE AND ITEM NUMBER OR REFERENCE DESIGNATION (CONTINUED)

FEDERAL STOCK NUMBER	FIGURE NUMBER	ITEM NUMBER OR REF. DESIGNATION	FEDERAL STOCK NUMBER	FIGURE NUMBER	ITEM NUMBER OR REF. DESIGNATION
5905-141-0591	3-14	1A4A4R37	5905-171-1986	3-20	1A5A7R24
5905-141-0591	3-17	1A4A5R20	5905-171-1986	3-23	1A5A5R24
5905-141-0591	3-17	1A4A5R38	5905-171-1986	3-25	1A5A4R24
590-141-0591	3-23	1A5A5R27	5905-171-1986	3-28	1A5A2R12
5905-141-0591	3-25	1A5A4R27	5905-171-1986	3-40	1A7A1R101
5905-141-0591	3-27	1A5A2R2	5905-171-1997	3-6	1A4A3R8
5905-141-0591	3-31	1A5A6R25	5905-171-1997	3-6	1A4A3R16
5905-141-0591	3-31	1A5A6R26	5905-171-1997	3-6	1A4A3R17
5905-1410591	3-53	1A6R26	5905-171-1997	3-23	1A5A5R12
5905-141-0595		1A4A4R66	5905-171-1997	3-23	1A5A5R31
5905-141-0595	3-12	1A4A2R9	5905-171-1997	3-25	1A5A4R12
5905-141-0595	3-17	1A4A5R3	5905-171-1997	3-25	1A5A4R31
5905-141-0595	3-25	1A7A1R103	5905-171-1997	3-29	1A5A3A1R13
5905-141-0595	3-40	1A7A1R105	5905-171-1997	3-30	1A5A3A2R13
5905-141-0597	3-12	1A4A2R15	5905-171-1997	3-31	1A5A6R30
5905-141-1073	3-12	1A4A2R15	5905-171-1998	3-9	1A4A3A7R13
5905-141-1073	3-36	1A3R36	5905-171-1998	3-12	1A4A2R2
5905-141-1118	3-10	1A4A3A2R24	5905-171-2002	3-10	1A4A3A2R24
5905-141-1118	3-38	1A3R3	5905-171-2002	3-17	1A4A4R13
5905-141-1130	3-5	1A4A1R18	5905-171-2002	3-17	1A4A5R5
5905-141-1165	3-27	1A5A2R2	5905-171-2002	3-28	1A5A2R8
5905-141-1311	3-23	1A5A5R19	5905-171-2002	3-48	1A8R4
5905-141-1311	3-25	1A5A4R19	5905-171-2004	3-27	1A5A2R2
5905-141-1311	3-31	1A5A6R18	5905-171-2005	3-7	1A4A3A3R3
5905-141-5416	3-12	1A4A2R15	5905-171-2005	3-7	1A4A3A3R8
5905-171-1985	3-7	1A4A3A3R6	5905-171-2005	3-12	1A4A2R6
5905-171-1986	3-8	1A4A3A6R4	5905-171-2005	3-12	1A4A2R18
5905-171-1986	3-10	1A4A3A2R30	5905-171-2005	3-23	1A5A5R31
5905-171-1986	3-12	1A4A2R13	5905-171-2005	3-25	1A5A4R31
5905-171-1986	3-20	1A5A7R22	5905-171-2005	3-29	1A5A3A1R3
5905-171-1986	3-20	1A5A7R23	5905-171-2005	3-29	1A5A3A1R4

SECTION IV INDEX-FEDERAL STOCK NUMBER AND REFERENCE NUMBER CROSS REFERENCE

TO FIGURE AND ITEM NUMBER OR REFERENCE DESIGNATION (CONTINUED)

FEDERAL STOCK NUMBER	FIGURE NUMBER	ITEM NUMBER OR REF. DESIGNATION	FEDERAL STOCK NUMBER	FIGURE NUMBER	ITEM NUMBER OR REF. DESIGNATION
5905-171-2005	3-29	1A5A3A1R5	5905-190-8879	3-5	1A4A1R16
5905-171-2005	3-29	1A5A3A1R6	5905-190-8879	3-9	1A4A3A7R2
5905-171-2005	3-30	1A5A3A2R3	5905-190-8879	3-10	1A4A3A2R13
5905-171-2005	3-30	1A5A3A2R4	5905-190-8879	3-10	1A4A3A2R16
5905-171-2005	3-30	1A5A3A2R5	5905-190-8879	3-10	1A4A3A2R21
5905-171-2005	3-30	1A5A3A2R6	5905-190-8879	3-12	1A4A2R15
5905-171-2005	3-31	1A5A6R30	5905-190-8879	3-12	1A4A2R19
5905-171-2005	3-49	1A1R1	5905-190-8879	3-14	1A4A4R7
5905-171-2009		1A4A5R40	5905-190-8879	3-14	1A4A4R18
5905-171-2009	3-6	1A4A3R15	5905-190-8879	3-14	1A4A4R26
5905-171-2009	3-12	1A4A2R20	5905-190-8879	3-17	1A4A5R36
5905-171-2009	3-6	1A4A3R18	5905-190-8879	3-32	1A5A6R12
5905-171-2009	3-17	1A4A5R37	5905-190-8882		1A4A5R24
5905-171-2009	3-18	1A4A3A6R11	5905-190-8882	3-7	1A4A3A3R4
5905-171-2009	3-29	1A5A3A1R14	5905-190-8882	3-12	1A4A2R15
5905-171-2009	3-30	1A5A3A2R14	5905-190-8882	3-17	1A4A5R14
5905-171-2009	3-45	1A7A4R203	5905-190-8882	3-17	1A4A5R16
5905-171-2009	3-45	1A7A4R204	5905-190-8882	3-31	1A5A6R13
5905-717-2527	3-14	1A4A4R28	5905-190-8882	3-53	1A6R2
5905-185-6946	3-12	1A4A2R15	5905-192-0390	3-14	1A4A4R34
5905-185-6946	3-20	1A5A7R6	5905-192-0390	3-19	1A5A1R3
5905-185-6946	3-20	1A5A7R10	5905-192-0390	3-20	1A5A7R7
5905-185-6966	3-14	1A4A4R38	5905-192-0390	3-23	1A5A5R26
5905-185-6966	3-23	1A5A5R31	5905-192-0390	3-25	1A5A4R26
5905-185-6966	3-25	1A5A4R31	5905-192-0390	3-27	1A5A2R1
5905-185-6966	3-31	1A5A6R30	5905-192-0390	3-48	1A8R3
5905-185-6966	3-51	1A9R1	5905-192-0626	3-34	1A10R7
5905-185-8516		1A5A7R31	5905-192-0649	3-27	1A5A2R2
5905-185-8518	3-8	1A4A3A6R10	5905-192-0662		1A5A4R32
5905-185-8518	3-8	1A4A3A6R15	5905-192-0662		1A5A5R32
5905-185-8518	3-8	1A4A3A6R16	5905-192-0662		1A5A6R32

SECTION IV INDEX-FEDERAL STOCK NUMBER AND REFERENCE NUMBER CROSS REFERENCE  
TO FIGURE AND ITEM NUMBER OR REFERENCE DESIGNATION (CONTINUED)

FEDERAL STOCK NUMBER	FIGURE NUMBER	ITEM NUMBER OR REF. DESIGNATION	FEDERAL STOCK NUMBER	FIGURE NUMBER	ITEM NUMBER OR REF. DESIGNATION
5905-192-0662	3-10	1A4A3A2R6	5905-192-4505	3-38	1A3R4
5905-192-0662	3-12	1A4A2R15	5905-195-0591	3-12	1A4A2R15
5905-192-0662	3-23	1A5A5R15	5905-095-5514	3-7	1A4A3A3R10
5905-192-0662	3-25	1A5A4R15	5905-195-5524		1A13R1
5905-192-0662	3-31	1A5A6R14	5905-195-6541	3-12	1A4A2R1
5905-192-0662	3-53	1A6R16	5905-195-6451	3-17	1A4A5R13
5905-192-0667	3-7	1A4A3A3R1	5905-195-6451	3-17	1A4A5R15
5905-192-0667	3-17	1A4A5R34	5905-195-6451	3-17	1A4A5R18
5905-192-0667	3-19	1A5A1R1	5905-195-6451	3-17	1A4A5R23
5905-192-0667	3-19	1A5A1R2	5905-195-6451	3-17	1A4A5R26
5905-192-0667	3-20	1A5A7R5	5905-195-6451	3-17	1A4A5R31
5905-192-3987		1A5A7R13	5905-195-6451	3-17	1A4A5R33
5905-192-3987	3-8	1A4A3A6R3	5905-195-6451	3-17	1A4A5R35
5905-192-3987	3-10	1A4A3A2R27	5905-195-6453	3-9	1A4A3A7R8
5905-192-3987	3-12	1A4A2R10	5905-195-6453	3-9	1A4A3A7R10
5905-192-3987	3-12	1A4A2R14	5905-195-6453	3-10	1A4A3A2R8
5905-192-3987	3-12	1A4A2R16	5905-195-6453	3-10	1A4A3A2R12
5905-192-3987	3-14	1A4A4R19	5905-195-6453	3-10	1A4A3A2R18
5905-192-3987	3-14	1A4A4R21	5905-195-6453	3-12	1A4A2R8
5905-192-3987	3-14	1A4A4R24	5905-195-6453	3-17	1A4A5R22
5905-192-3987	3-14	1A4A4R27	5905-195-6453	3-28	1A5A2R11
5905-192-3987	3-14	1A4A4R32	5905-195-6502	3-34	1A10R4
5905-192-3987	3-17	1A4A5R19	5905-195-6741	3-11	1A4A3A8R2
5905-192-3987	3-17	1A4A5R27	5905-195-6741	3-11	1A4A3A8R3
5905-192-3987	3-17	1A4A5R32	5905-195-6741	3-17	1A4A5R21
5905-192-3987	3-23	1A5A5R10	5905-195-6758	3-5	1A4A1R11
5905-192-3987	3-25	1A5A4R10	5905-195-6758	3-12	1A4A2R15
5905-192-3987	3-31	1A5A6R23	5905-195-6758	3-12	1A4A2R17
5905-192-3987	3-37	1A3R29	5905-195-6758	3-32	1A5A6R8
5905-192-3987	3-53	1A6R6	5905-195-6758	3-37	1A3R23
5905-192-3987	3-53	1A6R9	5905-195-6758	3-53	1A6R28

SECTION IV INDEX-FEDERAL STOCK NUMBER AND REFERENCE NUMBER CROSS REFERENCE  
TO FIGURE AND ITEM NUMBER OR REFERENCE DESIGNATION (CONTINUED)

FEDERAL STOCK NUMBER	FIGURE NUMBER	ITEM NUMBER OR REF. DESIGNATION	FEDERAL STOCK NUMBER	FIGURE NUMBER	ITEM NUMBER OR REF. DESIGNATION
5905-195-6800	3-23	1A5A5R31	5905-245-0023	3-17	1A4A5R4
5905-195-6800	3-43	1A7R26	5905-245-0023	3-24	1A5A5R17
5905-195-6806		1A4A5R25	5905-245-0023	3-26	1A5A4R17
5905-195-6806	3-6	1A4A3R11	5905-245-0023	3-32	1A5A6R16
5905-195-6806	3-8	1A4A3A6R20	5905-245-0023	3-40	1A7A1R104
5905-195-6806	3-14	1A4A4R1	5905-245-0023	3-53	1A6R27
5905-195-6806	3-14	1A4A4R2	5905-247-8687		1A5A7R19
5905-195-6806	3-14	1A4A4R11	5905-247-8710	3-17	1A4A5R1
5905-195-6806	3-14	1A4A4R12	5905-247-8710	3-53	1A6R13
5905-195-6806	3-14	1A4A4R17	5905-247-8732	3-3	1A4R1
5905-195-6806	3-14	1A4A4R25	5905-247-8732	3-3	1A4R2
5905-195-6806	3-14	1A4A4R40	5905-247-8732		1A4R3
5905-195-6806	3-14	1A4A4R56	5905-247-8732		1A4R4
5905-195-6806	3-17	1A4A5R17	5905-249-3663	3-38	1A3R48
5905-195-6806	3-17	1A4A5R39	5905-249-4217		1A4A4R65
5905-195-6806	3-24	1A5A5R1	5905-249-4217	3-14	1A4A4R16
5905-195-6806	3-26	1A5A4R1	5905-249-4248	3-8	1A4A3A6R8
5905-195-6806	3-32	1A5A6R1	5905-249-4248	3-12	1A4A2R15
5905-221-5860	3-12	1A4A2R4	5905-249-4248	3-24	1A5A5R28
5905-221-5860	3-12	1A4A2R5	5905-249-4248	3-26	1A5A4R28
5905-221-5860	3-12	1A4A2R15	5905-249-4248	3-40	1A7A1R102
5905-221-5860	3-31	1A5A6R24	5905-249-4248	3-53	1A6R3
5905-221-5860	3-40	1A7A1R110	5905-251-7757	3-10	1A4A3A2R24
5905-225-4027		1A2A1R3	5905-252-5428	3-9	1A4A3A7R3
5905-225-4027		1A2A1R4	5905-252-5428	3-10	1A4A3A2R19
5905-228-6088	3-11	1A4A3A8R6	5905-252-5428	3-10	1A4A3A2R24
5905-245-0023	3-6	1A4A3R21	5905-252-5428	3-14	1A4A4R9
5905-245-0023	3-8	1A4A3A6R7	5905-252-5428	3-14	1A4A4R15
5905-245-0023	3-9	1A4A3A7R15	5905-252-5428	3-14	1A4A4R22
5905-245-0023	3-10	1A4A3A2R15	5905-252-5428	3-14	1A4A4R30
5905-245-0023	3-12	1A4A2R21	5905-252-5428	3-14	1A4A4R62

SECTION IV INDEX-FEDERAL STOCK NUMBER AND REFERENCE NUMBER CROSS REFERENCE  
TO FIGURE AND ITEM NUMBER OR REFERENCE DESIGNATION (CONTINUED)

FEDERAL STOCK NUMBER	FIGURE NUMBER	ITEM NUMBER OR REF. DESIGNATION	FEDERAL STOCK NUMBER	FIGURE NUMBER	ITEM NUMBER OR REF. DESIGNATION
5905-253-1229		1A9R4	5905-256-0410	3-23	1A5A5R31
5905-253-1231	3-23	1A5A5R20	5905-256-0410	3-25	1A5A4R31
5905-253-1231	3-25	1A5A4R20	5905-256-0410	3-31	1A5A6R30
5905-253-1231	3-31	1A5A6R19	5905-256-0411	3-51	1A9R3
5905-254-7097	3-6	1A4A3R32	5905-257-0926	3-14	1A4A4R39
5905-254-7097	3-7	1A4A3A3R2	5905-257-0937	3-37	1A3R20
5905-254-7097	3-12	1A4A2R15	5905-257-2631	3-10	1A4A3A2R10
5905-254-7097	3-53	1A6R12	5905-257-2631	3-10	1A4A3A2R31
5905-254-7097	3-53	1A6R17	5905-257-2631	3-20	1A5A7R8
5905-254-7101	3-34	1A1OR3	5905-257-2631	3-20	1A5A7R9
5905-254-7101	3-37	1A3R15	5905-257-2631	3-27	1A5A2R5
5905-254-7101	3-37	1A3R30	5905-257-2631	3-53	1A6R20
5905-254-7101	3-37	1A3R31	5905-258-6949	3-38	1A3R16
5905-254-7101	3-37	1A3R32	5905-279-1692		1A2R1
5905-254-7101	3-37	1A3R33	5905-279-1692		1A2R2
5905-254-7101	3-37	1A3R34	5905-279-1756	3-19	1A5A1R4
5905-254-7101	3-37	1A3R35	5905-279-1756	3-23	1A5A5R31
5905-254-9201	3-10	1A4A3A2R25	5905-279-1756	3-24	1A5A5R3
5905-254-9201	3-10	1A4A3A2R26	5905-279-1756	3-25	1A5A4R31
5905-256-0387	3-8	1A4A3A6R13	5905-279-1756	3-26	1A5A4R3
5905-256-0387	3-23	1A5A5R31	5905-279-1756	3-31	1A5A6R9
5905-256-0387	3-25	1A5A4R31	5905-279-1756	3-31	1A5A6R30
5905-256-0387	3-31	1A5A6R30	5905-279-1756	3-32	1A5A6R3
5905-256-0387	3-48	1A8R10	5905-279-1756	3-42	1A7R3
5905-256-0387	3-51	1A9R2	5905-279-1756	3-42	1A7R4
5905-256-0409	3-9	1A4A3A7R1	5905-279-1756	3-42	1A7R5
5905-256-0409	3-10	1A4A3A2R14	5905-279-1756	3-42	1A7R6
5905-256-0409	3-10	1A4A3A2R17	5905-279-1756	3-43	1A7R11
5905-256-0409	3-23	1A5A5R31	5905-279-1756	3-43	1A7R12
5905-256-0409	3-25	1A5A4R31	5905-279-1756	3-43	1A7R14
5905-256-0409	3-31	1A5A6R30	5905-279-1756	3-43	1A7R15



SECTION IV INDEX-FEDERAL STOCK NUMBER AND REFERENCE NUMBER CROSS REFERENCE  
TO FIGURE AND ITEM NUMBER OR REFERENCE DESIGNATION (CONTINUED)

FEDERAL STOCK NUMBER	FIGURE NUMBER	ITEM NUMBER OR REF. DESIGNATION	FEDERAL STOCK NUMBER	FIGURE NUMBER	ITEM NUMBER OR REF. DESIGNATION
5905-279-1869	3-14	1A4A4R4	5905-295-3410	3-6	1A4A3R9
5905-279-1869	3-43	1A7R27	5905-295-3410	3-7	1A4A3A3R7
5905-279-1871	3-12	1A4A2R15	5905-295-3410	3-12	1A4A2R15
5905-279-1898	3-10	1A4A3A2R24	5905-295-3410	3-23	1A5A5R30
5905-279-1918	3-38	1A3R37	5905-295-3410	3-24	1A5A5R9
5905-279-1976	3-34	1A10R2	5905-295-3410	3-24	1A5A5R13
5905-279-1976	3-38	1A3R11	5905-295-3410	3-25	1A5A4R30
5905-279-1976	3-38	1A3R12	5905-295-3410	3-26	1A5A4R9
5905-279-1976	3-38	1A3R25	5905-295-3410	3-26	1A5A4R13
5905-279-2019	3-5	1A4A1R2	5905-295-3410	3-38	1A3R2
5905-279-2029	3-23	1A5A5R2	5905-295-3410	3-53	1A6R1
5905-279-2029	3-23	1A5A5R5	5905-299-2012	3-48	1A8R9
5905-279-2303	3-34	1A10R6	5905-299-2014	3-6	1A4A3R5
5905-279-2303	3-38	1A3R1	5905-299-2014	3-53	1A6R11
5905-279-2529	3-14	1A4A4R5	5905-299-2016	3-6	1A4A3R14
5905-279-2529	3-14	1A4A4R20	5905-299-2016	3-32	1A5A6R27
5905-279-2529	3-14	1A4A4R33	5905-299-2024	3-53	1A6R5
5905-279-2628	3-5	1A4A1R17	5905-299-2024	3-53	1A6R14
5905-279-2643	3-20	1A5A7R25	5905-299-2025	3-24	1A5A5R14
5905-279-2643	3-34	1A10R5	5905-299-2025	3-26	1A5A4R14
5905-279-2658	3-10	1A4A3A2R24	5905-299-2027	3-34	1A10R8
5905-279-2658	3-14	1A4A4R59	5905-299-2301	3-6	1A4A3R9
5905-279-2658	3-23	1A5A5R6	5905-299-2033	3-6	1A4A3R2
5905-279-2658	3-31	1A5A6R6	5905-299-2039	3-19	1A5A1R5
5905-279-2669	3-27	1A5A2R2	5905-299-2049	3-11	1A4A3A8R5
5905-279-3499	3-27	1A5A2R2	5905-299-2054	3-38	1A3R6
5905-279-3527	3-14	1A4A4R63	5905-299-2058		1A5A7R21
5905-283-6941	3-17	1A4A5R29	5905-299-2058	3-20	1A5A7R20
5905-295-3403	3-5	1A4A1R1	5905-369-6923	3-6	1A4A3R13
5905-295-3410		1A6R8	5905-473-5251	3-14	1A4A4R6
5905-295-3410	3-6	1A4A3R7	5905-473-5251	3-43	1A7R28

SECTION IV INDEX-FEDERAL STOCK NUMBER AND REFERENCE NUMBER CROSS REFERENCE  
 TO FIGURE AND ITEM NUMBER OR REFERENCE DESIGNATION (CONTINUED)

FEDERAL STOCK NUMBER	FIGURE NUMBER	ITEM NUMBER OR REF. DESIGNATION	FEDERAL STOCK NUMBER	FIGURE NUMBER	ITEM NUMBER OR REF. DESIGNATION
5905-542-7637	3-38	1A3R7	5905-704-6193		1A2A1R3
5905-542-7637	3-38	1A3R8	5905-704-6193		1A2A1R4
5905-542-7638	3-38	1A3R14	5905-752-3157		1A4A2R22
5905-542-7639	3-20	1A5A7R1	5905-752-3335	3-9	1A4A3A7R4
5905-542-7639	3-20	1A5A7R2	5905-752-3653	3-38	1A3R5
5905-542-7641	3-29	1A5A3A1R9	5905-752-7450	3-37	1A3R18
5905-542-7641	3-29	1A5A3A1R10	5905-763-3599		1A2A1R3
5905-542-7641	3-29	1A5A3A2R10	5905-763-3599		1A2A1R4
5905-542-7641	3-30	1A5A3A2R9	5905-763-3600		1A2A1R3
5905-542-7643	3-45	1A7A4R205	5905-763-3600		1A2A1R4
5905-542-7666	3-35	1A12R2	5905-763-3601		1A2A1R3
5905-542-7666	3-35	1A12R3	5905-763-3601		1A2A1R4
5905-542-7666	3-35	1A12R4	5905-763-9208		1A2A1R3
5905-542-7667	3-48	1A8R1	5905-763-9208		1A2A1R4
5905-552-3560	3-40	1A7A1R106	5905-764-4969	3-38	1A3R9
5905-555-7917		1A5A4R33	5905-764-4969	3-38	1A3R10
5905-556-7917		1A5A5R33	5905-765-5470		1A2A1R3
5905-556-7917		1A5A6R31	5905-765-5470		1A2A1R4
5905-577-7427	3-17	1A4A5R7	5905-772-1053		1A2A1R3
5905-577-7427	3-17	1A4A5R8	5905-772-1053		1A2A1R4
5905-660-3974	3-40	1A7A1R109	5905-774-5166	3-21	1A5A7R16
5905-678-5096	3-21	1A5A7R15	5905-774-5166	3-52	1A6R19
5905-678-5320	3-20	1A5A7R3	5905-801-5430	3-11	1A4A3A8R1
5905-679-9351	3-5	1A4A1R8	5905-807-4201	3-53	1A6R18
5905-679-9351	3-5	1A4A1R14	5905-811-0673	3-54	1A6A1R2
5905-679-9486	3-43	1A7R16	5905-811-0673	3-54	1A6A1R6
5905-679-9486	3-43	1A7R21	5905-813-8640		1A2A1R3
5905-679-9509	3-35	1A12R1	5905-813-8640		1A2A1R4
5905-686-4529	3-54	1A6A1R5	5905-814-0738		1A2A1R3
5905-702-5826		1A2A1R5	5905-814-0738		1A2A1R4
5905-702-5826		1A2A1R6	5905-816-8554	3-9	1A4A3A7R7

SECTION IV INDEX-FEDERAL STOCK NUMBER AND REFERENCE NUMBER CROSS REFERENCE  
TO FIGURE AND ITEM NUMBER OR REFERENCE DESIGNATION (CONTINUED)

FEDERAL STOCK NUMBER	FIGURE NUMBER	ITEM NUMBER OR REF. DESIGNATION	FEDERAL STOCK NUMBER	FIGURE NUMBER	ITEM NUMBER OR REF. DESIGNATION
5905-816-8554	3-54	1A6A1R4	5905-902-5402		1A2A1R1
5905-818-0129	3-42	1A7R1	5905-902-5402		1A2A1R2
5905-818-0129	3-42	1A7R2	5905-914-4381	3-29	1A5A3A1R7
5905-818-0129	3-42	1A7R10	5905-914-4381	3-29	1A5A3A1R8
5905-029-2897		1A2A1R3	5905-914-4381	3-30	1A5A3A2R7
5905-829-2897		1A2A1R4	5905-914-4381	3-30	1A5A3A2R8
5905-834-2961	3-23	1A5A5R25	5905-925-1524		1A2A1P3
5905-834-2961	3-25	1A5A4R25	5905-925-1524		1A2A1R4
5905-837-7837	3-34	1A10R9	5905-942-9326	3-8	1A4A3A6R18
5905-837-7837	3-34	1A10R10	5905-942-9326	3-25	1A5A4R31
5905-839-4646	3-51	1A9R5	5905-942-9326	3-31	1A5A6R30
5905-844-8297	3-47	1A8R2	5905-949-0795	3-47	1A8R8
5905-848-8924	3-29	1A5A3A1R11	5905-950-5594	3-20	1A5A7R18
5905-848-8924	3-29	1A5A3A1R12	5905-950-6790		1A2A1R5
5905-848-8924	3-30	1A5A3A2R11	5905-950-6790		1A2A1R6
5905-848-8924	3-30	1A5A3A2R12	5905-950-6793		1A2A1R3
5905-857-2445		1A2A1R3	5905-950-6793		1A2A1R4
5905-857-2445		1A2A1R4	5905-951-4045	3-5	1A4A1R3
5905-859-7865	3-37	1A3R19	5905-951-4045	3-5	1A4A1R6
5905-879-0596		1A4A4R67	5905-951-4045	3-5	1A4A1R7
5905-882-3028	3-34	1A10R1	5905-951-4045	3-5	1A4A1R10
5905-883-9198		1A2A1R5	5905-951-4045	3-5	1A4A1R12
5905-883-9198		1A2A1R6	5905-951-4045	3-5	1A4A1R15
5905-892-7276		1A2A1R3	5905-951-8527	3-43	1A7R17
5905-892-7276		1A2A1R4	5905-951-8527	3-43	1A7R18
5905-892-7283		1A2A1R3	5905-951-8527	3-43	1A7R19
5905-892-7283		1A2A1R4	5905-951-8527	3-43	1A7R20
5905-892-7283	3-9	1A4A3A7R5	5905-951-8527	3-43	1A7R22
5905-894-3488		1A1R3	5905-951-8527	3-43	1A7R23
5905-901-6490	3-45	1A7A4R201	5905-951-8527	3-43	1A7R24
5905-901-6490	3-45	1A7A4R202	5905-951-8527	3-43	1A7R25

SECTION IV INDEX-FEDERAL STOCK NUMBER AND REFERENCE NUMBER CROSS REFERENCE  
TO FIGURE AND ITEM NUMBER OR REFERENCE DESIGNATION (CONTINUED)

FEDERAL STOCK NUMBER	FIGURE NUMBER	ITEM NUMBER OR REF. DESIGNATION	FEDERAL STOCK NUMBER	FIGURE NUMBER	ITEM NUMBER OR REF. DESIGNATION
5905-952-4716		1A2A1R5	5905-993-6011		1A2A1R6
5905-952-4716		1A2A1R6	5905-993-6012		1A2A1R5
5905-954-2517		1A5A7R17	5905-993-6012		1A2A1R6
5905-957-0453		1A2A1R3	5905-993-6012	3-48	1A8R7
5905-957-0453		1A2A1R4	5905-993-6341	3-10	1A4A3A2R11
5905-959-6008		1A2A1R3	5910-006-7106	3-31	1A5A6C6
5905-959-6008		1A2A1R4	5910-012-7734	3-49	1A1C2
5905-964-2219		1A2A1R3	5910-027-3054	3-38	1A3C18
5905-964-2219		1A2A1R4	5910-027-9964	3-23	1A5A5C8
5905-964-2376		1A2A1R5	5910-027-9964	3-25	1A5A4C8
5905-964-2376		1A2A1R6	5910-027-9964	3-31	1A5A6C6
5905-985-2409		1A2A1R3	5910-027-9966	3-27	1A5A2C3
5905-985-2409		1A2A1R4	5910-027-9976	3-10	1A4A3A2C26
5905-988-0160		1A2A1R5	5910-027-9976	3-10	1A4A3A2C27
5905-988-0160		1A2A1R6	5910-028-1308	3-54	1A6A1C11
5905-989-5579		1A2A1R3	5910-043-2939	3-17	1A4A5C20
5905-989-5579		1A2A1R4	5910-043-2939	3-53	1A6C5
5905-989-5577		1A2A1R3	5910-044-4036	3-17	1A4A5C20
5905-989-5577		1A2A1R4	5910-044-4895	3-34	1A10C1
5905-989-6488		1A2A1R3	5910-044-4895	3-34	1A10C2
5905-989-6488		1A2A1R4	5910-044-4958	3-54	1A6A1C10
5905-990-5153		1A2A1R5	5910-044-4959	3-54	1A6A1C10
5905-990-5153		1A2A1R6	5910-044-4961	3-5	1A4A1C4
5905-993-2261	3-53	1A6R29	5910-044-4963	3-23	1A5A5C8
5905-993-2263		1A4A3A2F9	5910-044-4963	3-25	1A5A4C8
5905-993-2268	3-10	1A4A3A2R28	5910-044-4963	3-31	1A5A6C6
5905-993-2268	3-10	1A4A3A2R29	5910-045-5315	3-27	1A5A2C18
5905-993-2268	3-38	1A3R26	5910-045-5432	3-53	1A6C21
5905-993-2268	3-38	1A3R28	5910-051-1997	3-54	1A6A1C10
5905-993-5961	3-20	1A5A7R12	5910-051-1998	3-54	1A6A1C10
5905-993-6011		1A2A1R5	5910-051-4590	3-2	1A4C45

SECTION IV INDEX-FEDERAL STOCK NUMBER AND REFERENCE NUMBER CROSS REFERENCE  
TO FIGURE AND ITEM NUMBER OR REFERENCE DESIGNATION (CONTINUED)

FEDERAL STOCK NUMBER	FIGURE NUMBER	ITEM NUMBER OR REF. DESIGNATION	FEDERAL STOCK NUMBER	FIGURE NUMBER	ITEM NUMBER OR REF. DESIGNATION
5910-057-4140	3-19	1A5A1C6	5910-071-1642	3-31	1A5A6C6
5910-057-5218	3-8	1A4A3A6C11	5910-079-5253	3-17	1A4A5C20
5910-057-5218	3-24	1A5A5C20	5910-080-3688	3-23	1A5A5C8
5910-057-5218	3-26	1A5A4C20	5910-080-3688	3-25	1A5A4C8
5910-057-5218	3-32	1A5A6C20	5910-080-3688	3-29	1A5A3A1C5
5910-060-9619		1A4A4C53	5910-080-3688	3-30	1A5A3A2C5
5910-060-9619	3-6	1A4A3C20	5910-080-3688	3-31	1A5A6C6
5910-060-9619	3-8	1A4A3A6C10	5910-080-3690	3-29	1A5A3A1C3
5910-060-9619	3-9	1A4A3A7C3	5910-080-3690	3-29	1A5A3A1C4
5910-060-9619	3-10	1A4A3A2C31	5910-080-3690	3-30	1A5A3A2C3
5910-060-9619	3-12	1A4A2C32	5910-080-3690	3-30	1A5A3A2C4
5910-060-9619	3-17	1A4A5C38	5910-082-4893	3-17	1A4A5C23
5910-060-9619	3-19	1A5A1C2	5910-082-4893	3-17	1A4A5C27
5910-060-9619	3-24	1A5A5C11	5910-082-4898	3-17	1A4A5C20
5910-060-9619	3-26	1A5A4C11	5910-192-2120	3-37	1A3C11
5910-060-9619	3-26	1A5A4C14	5910-192-2120	3-37	1A3C22
5910-060-9619	3-27	1A5A2C1	5910-192-2120	3-37	1A3C23
5910-060-9619	3-28	1A5A2C9	5910-192-2120	3-37	1A3C24
5910-060-9619	3-32	1A5A6C10	5910-195-5392	3-6	1A4A3C29
5910-060-9619	3-32	1A5A6C13	5910-195-5392	3-6	1A4A3C35
5910-061-5427	3-37	1A3C10	5910-195-8771		1A2A2C2
5910-061-5427	3-37	1A3C33	5910-195-8771		1A2A2C3
5910-061-7356	3-37	1A3C73	5910-195-8771		1A2A2C4
5910-061-7453	3-23	1A5A5C8	5910-195-8771		1A2A2C5
5910-061-7453	3-25	1A5A4C8	5910-195-8771		1A2A2C6
5910-061-7453	3-31	1A5A6C6	5910-195-8771		1A2A2C7
5910-062-9619	3-23	1A5A5C14	5910-195-8771		1A2A2C8
5910-063-8424	3-37	1A3C71	5910-195-8771		1A2A2C9
5910-069-0381	3-40	1A7A1C103	5910-195-8771		1A2A2C10
5910-071-1642	3-23	1A5A5C8	5910-195-8771		1A2A2C11
5910-071-1642	3-25	1A5A4C8	5910-244-1622	3-54	1A6A1C10

SECTION IV INDEX-FEDERAL STOCK NUMBER AND REFERENCE NUMBER CROSS REFERENCE  
TO FIGURE AND ITEM NUMBER OR REFERENCE DESIGNATION (CONTINUED)

FEDERAL STOCK NUMBER	FIGURE NUMBER	ITEM NUMBER OR REF. DESIGNATION	FEDERAL STOCK NUMBER	FIGURE NUMBER	ITEM NUMBER OR REF. DESIGNATION
5910-264-9442	3-38	1A3C17	5910-542-7518	3-12	1A4A2C23
5910-269-4613	3-23	1A5A5C16	5910-542-7518	3-12	1A4A2C30
5910-269-4613	3-25	1A5A4C16	5910-542-7518	3-12	1A4A2C29
5410-279-4122	3-53	1A6C27	5910-542-7518	3-12	1A4A2C31
5910-280-9297	3-17	1A4A5C22	5910-542-7522	3-24	1A5A5C17
5910-280-9297	3-17	1A4A5C35	5910-542-7522	3-26	1A5A4C17
5910-519-6124	3-6	1A4A3C31	5910-542-7551	3-17	1A4A5C2
5910-542-1427	3-6	1A4A3C3	5910-543-9197	3-19	1A5A1C8
5910-542-7365	3-34	1A10C3	5910-543-9552	3-15	1A4A4C25
5910-542-7367	3-43	1A7C22	5910-552-9868	3-2	1A4C23
5910-542-7368	3-34	1A10C4	5910-552-9868	3-2	1A4C25
5910-542-7371	3-23	1A5A5C24	5910-552-9868	3-2	1A4C26
5910-542-7371	3-25	1A5A4C24	5910-552-9868	3-2	1A4C28
			5910-552-9868	3-2	1A4C31
			5910-552-9868	3-2	1A4C32
5910-542-7373	3-40	1A7A1C104	5910-552-9868	3-2	1A4C35
5910-542-7373	3-41	1A7A1C102	5910-552-9868	3-2	1A4C36
5910-542-7373	3-45	1A7A4C201	5910-552-9868	3-2	1A4C38
5910-542-7377	3-37	1A3C30	5910-552-9868	3-6	1A4A3C37
5910-542-7379	3-37	1A3C31	5910-553-4994		1A5A7C36
5910-542-7387		1A5A6C29	5910-553-5036	3-5	1A4A1C13
5910-542-7387	3-6	1A4A3C40	5910-553-5036	3-5	1A4A1C14
5910-542-7427		1A4A4C7	5910-553-5036	3-5	1A4A1C15
5910-542-7427		1A4A4C19	5910-553-5036	3-19	1A5A1C7
5910-542-7517	3-12	1A4A2C14	5910-553-7289	3-17	1A4A5C35
5910-542-7518	3-12	1A4A2C6	5910-553-7289	3-31	1A5A6C16
5910-542-7518	3-12	1A4A2C8	5910-556-1425	3-2	1A4C41
5910-542-7518	3-12	1A4A2C10	5910-556-1425	3-2	1A4C42
5910-542-7518	3-12	1A4A2C11	5910-556-1425	3-2	1A4C44
5910-542-7518	3-12	1A4A2C12	5910-556-1425	3-37	1A3C72
5910-542-7518	3-12	1A4A2C15	5910-556-1425	3-38	1A3C4
			5910-556-1425	3-38	1A3C5

SECTION IV INDEX-FEDERAL STOCK NUMBER AND REFERENCE NUMBER CROSS REFERENCE  
 TO FIGURE AND ITEM NUMBER OR REFERENCE DESIGNATION (CONTINUED)

FEDERAL STOCK NUMBER	FIGURE NUMBER	ITEM NUMBER OR REF. DESIGNATION	FEDERAL STOCK NUMBER	FIGURE NUMBER	ITEM NUMBER OR REF. DESIGNATION
5910-556-1425	3-43	1A7C23	5910-615-4101	3-2	1A4C10
5910-556-1425	3-48	1A8C4	5910-615-4101	3-2	1A4C11
5910-556-1425	3-53	1A6C1	5910-615-4101	3-2	1A4C12
5910-556-1425	3-53	1A6C10	5910-615-4101	3-2	1A4C13
5910-556-1425	3-53	1A6C11	5910-615-4101	3-2	1A4C14
5910-556-1425	3-53	1A6C18	5910-615-4101	3-2	1A4C15
5910-577-1414	3-8	1A4A3A6C1	5910-615-4101	3-2	1A4C16
5910-577-6971	3-5	1A4A1C8	5910-615-4101	3-2	1A4C17
5910-577-6971	3-5	1A4A1C9	5910-615-4101	3-2	1A4C18
5910-577-6971	3-5	1A4A1C10	5910-615-4101	3-2	1A4C19
5910-577-6971	3-5	1A4A1C11	5910-615-4101	3-20	1A5A7C1
5910-581-9801	3-12	1A4A2C25	5910-615-4101	3-20	1A5A7C2
5910-581-9801	3-27	1A5A2C11	5910-615-4101	3-20	1A5A7C3
5910-581-9801	3-27	1A5A2C12	5910-615-4101	3-20	1A5A7C4
5910-583-1256	3-51	1A9C3	5910-615-4101	3-20	1A5A7C5
5910-583-1953	3-17	1A4A5C21	5910-615-4101	3-20	1A5A7C6
5910-613-4414	3-15	1A4A4C146	5910-615-4101	3-20	1A5A7C7
5910-615-0537	3-37	1A3C7	5910-615-4101	3-20	1A5A7C8
5910-615-4101		1A2C1	5910-615-4101	3-20	1A5A7C9
5910-615-4101		1A2C2	5910-615-4101	3-20	1A5A7C10
5910-615-4101		1A2C3	5910-615-4101	3-20	1A5A7C11
5910-615-4101		1A2C4	5910-615-4101	3-20	1A5A7C12
5910-615-4101	3-2	1A4C1	5910-615-4101	3-20	1A5A7C13
5910-615-4101	3-2	1A4C2	5910-615-4101	3-20	1A5A7C14
5910-615-4101	3-2	1A4C3	5910-615-4101	3-20	1A5A7C15
5910-615-4101	3-2	1A4C4	5910-615-4101	3-20	1A5A7C16
5910-615-4101	3-2	1A4C5	5910-615-4101	3-20	1A5A7C17
5910-615-4101	3-2	1A4C6	5910-615-4101	3-20	1A5A7C18
5910-615-4101	3-2	1A4C7	5910-615-4101	3-20	1A5A7C19
5910-615-4101	3-2	1A4C8	5910-615-4101	3-20	1A5A7C20
5910-615-4101	3-2	1A4C9	5910-615-4101	3-20	1A5A7C21

SECTION IV INDEX-FEDERAL STOCK NUMBER AND REFERENCE NUMBER CROSS REFERENCE  
 TO FIGURE AND ITEM NUMBER OR REFERENCE DESIGNATION (CONTINUED)

FEDERAL STOCK NUMBER	FIGURE NUMBER	ITEM NUMBER OR REF. DESIGNATION	FEDERAL STOCK NUMBER	FIGURE NUMBER	ITEM NUMBER OR REF. DESIGNATION
5910-615-4101	3-20	1A5A7C22	5910-615-4101	3-38	1A3C65
5910-615-4101	3-20	1A5A7C23	5910-615-4101	3-38	1A3C66
5910-615-4101	3-20	1A5A7C24	5910-615-4101	3-38	1A3C67
5910-615-4101	3-20	1A5A7C25	5910-615-4101	3-38	1A3C68
5910-615-4101	3-20	1A5A7C26	5910-615-4101	3-49	1A1C1
5910-615-4101	3-20	1A5A7C27	5910-615-4101	3-54	1A6A1C1
5910-615-4101	3-20	1A5A7C28	5910-615-4101	3-54	1A6A1C2
5910-615-4101	3-20	1A5A7C29	5910-615-4101	3-54	1A6A1C3
5910-615-4101	3-20	1A5A7C30	5910-617-3246	3-12	1A4A2C2
5910-615-4101	3-20	1A5A7C31	5910-617-3246	3-19	1A5A1C9
5910-615-4101	3-20	1A5A7C32	5910-617-3246	3-27	1A5A2C2
5910-615-4101	3-20	1A5A7C33	5910-617-3246	3-27	1A5A2C14
5910-615-4101	3-20	1A5A7C34	5910-617-3246	3-28	1A5A2C13
5910-615-4101	3-20	1A5A7C35	5910-617-3246	3-28	1A5A2C16
5910-615-4101	3-37	1A3C39	5910-617-3246	3-28	1A5A2C17
5910-615-4101	3-37	1A3C40	5910-644-0486	3-53	1A6C2
5910-615-4101	3-37	1A3C56	5910-649-0295	3-6	1A4A3C21
5910-615-4101	3-37	1A3C69	5910-649-0295	3-6	1A4A3C23
5910-615-4101	3-37	1A3C74	5910-649-0295	3-6	1A4A3C26
5910-615-4101	3-38	1A3C42	5910-649-0544	3-48	1A8C3
5910-615-4101	3-38	1A3C45	5910-655-0137	3-27	1A5A2C7
5910-615-4101	3-38	1A3C46	5910-655-0137	3-28	1A5A2C6
5910-615-4101	3-38	1A3C47	5910-655-0390	3-5	1A4A1C7
5910-615-4101	3-38	1A3C57	5910-655-0390	3-12	1A4A2C7
5910-615-4101	3-38	1A3C58	5910-663-4562	3-29	1A5A3A1C5
5910-615-4101	3-38	1A3C59	5910-663-4562	3-30	1A5A3A2C5
5910-615-4101	3-38	1A3C60	5910-663-4759		1A4A4C185
5910-615-4101	3-38	1A3C61	5910-663-4759	3-12	1A4A2C16
5910-615-4101	3-38	1A3C62	5910-663-4759	3-15	1A4A4C13
5910-615-4101	3-38	1A3C63	5910-663-4759	3-15	1A4A4C94
5910-615-4101	3-38	1A3C64	5910-663-5572	3-15	1A4A4C178



SECTION IV INDEX-FEDERAL STOCK NUMBER AND REFERENCE NUMBER CROSS REFERENCE  
TO FIGURE AND ITEM NUMBER OR REFERENCE DESIGNATION (CONTINUED)

FEDERAL STOCK NUMBER	FIGURE NUMBER	ITEM NUMBER OR REF. DESIGNATION	FEDERAL STOCK NUMBER	FIGURE NUMBER	ITEM NUMBER OR REF. DESIGNATION
5910-663-5572	3-17	1A4A5C38	5910-667-8866	3-15	1A4A4C106
5910-663-5780	3-6	1A4A3C15	5910-667-8866	3-15	1A4A4C107
5910-663-5780	3-28	1A5A2C8	5910-667-8866	3-15	1A4A4C110
5910-663-5850		1A4A3A6C8	5910-667-8866	3-15	1A4A4C115
5910-663-5850		1A4A3A6C9	5910-667-8866	3-15	1A4A4C116
5910-663-5850	3-8	1A4A3A6C5	5910-667-8866	3-15	1A4A4C117
5910-663-5850	3-19	1A5A1C10	5910-667-8866	3-15	1A4A4C123
5910-663-5850	3-29	1A5A3A1C3	5910-667-8866	3-15	1A4A4C133
5910-663-5850	3-29	1A5A3A1C4	5910-667-8866	3-15	1A4A4C159
5910-663-5850	3-30	1A5A3A2C3	5910-667-8866	3-15	1A4A4C160
5910-663-5850	3-30	1A5A3A2C4	5910-667-8866	3-15	1A4A4C161
5910-666-7228	3-15	1A4A4C61	5910-667-8866	3-15	1A4A4C162
5910-666-7228	3-15	1A4A4C109	5910-667-8866	3-15	1A4A4C163
5910-666-7905	3-15	1A4A4C11	5910-667-8866	3-15	1A4A4C164
5910-667-6637		1A4A4C39	5910-667-8866	3-15	1A4A4C165
5910-667-6637		1A4A4C41	5910-667-8866	3-15	1A4A4C166
5910-667-6637		1A4A4C43	5910-667-8866	3-15	1A4A4C167
5910-667-6637		1A4A4C60	5910-667-8866	3-15	1A4A4C168
5910-667-6637		1A4A4C87	5910-667-8866	3-15	1A4A4C169
5910-667-6637		1A4A4C125	5910-667-8866	3-15	1A4A4C172
5910-667-6637		1A4A4C141	5910-667-8866	3-15	1A4A4C173
5910-667-6637		1A4A4C149	5910-667-8866	3-15	1A4A4C175
5910-667-6637	3-6	1A4A3C30	5910-668-3647	3-37	1A3C20
5910-667-6637	3-6	1A4A3C36	5910-668-4728	3-5	1A4A1C2
5910-667-8866		1A4A4C103	5910-668-7223	3-46	1A11C1
5910-667-8866	3-15	1A4A4C67	5910-668-7488	3-54	1A6A1C10
5910-667-8866	3-15	1A4A4C90	5910-669-3356	3-54	1A6A1C10
5910-667-8866	3-15	1A4A4C96	5910-678-5079	3-6	1A4A3C14
5910-667-8866	3-15	1A4A4C97	5910-678-5079	3-12	1A4A2C24
5910-667-8866	3-15	1A4A4C98	5910-678-5079	3-15	1A4A4C62
5910-667-8866	3-15	1A4A4C101	5910-678-5306		1A4A4C183

SECTION IV INDEX-FEDERAL STOCK NUMBER AND REFERENCE NUMBER CROSS REFERENCE  
 TO FIGURE AND ITEM NUMBER OR REFERENCE DESIGNATION (CONTINUED)

FEDERAL STOCK NUMBER	FIGURE NUMBER	ITEM NUMBER OR REF. DESIGNATION	FEDERAL STOCK NUMBER	FIGURE NUMBER	ITEM NUMBER OR REF. DESIGNATION
5910-678-5306	3-6	1A4A3C5	5910-678-5306	3-15	1A4A4C179
5310-678-5306	3-6	1A4A3C9	5910-678-5327	3-53	1A6C7
5910-678-5306	3-6	1A4A3C10	5910-678-5327	3-54	1A6A1C7
5910-678-5306	3-6	1A4A3C13	5910-678-5334	3-53	1A6C4
5910-678-5306	3-6	1A4A3C16	5910-678-5334	3-53	1A6C6
5910-678-5306	3-6	1A4A3C17	5910-678-5335	3-53	1A6C13
5910-678-5306	3-6	1A4A3C18	5910-678-5335	3-53	1A6C14
5910-678-5306	3-15	1A4A4C1	5910-679-1993	3-15	1A4A4C5
5910-678-5306	3-15	1A4A4C4	5910-679-1993	3-15	1A4A4C8
5910-678-5306	3-15	1A4A4C17	5910-679-1993	3-15	1A4A4C15
5910-678-5306	3-15	1A4A4C23	5910-679-1993	3-15	1A4A4C21
5910-678-5306	3-15	1A4A4C44	5910-679-5335	3-53	1A6C15
5910-678-5306	3-15	1A4A4C45	5910-679-5335	3-53	1A6C16
5910-678-5306	3-15	1A4A4C47	5910-679-9322	3-38	1A3C9
5910-678-5306	3-15	1A4A4C63	5910-679-9388	3-8	1A4A3A6C7
5910-678-5306	3-15	1A4A4C92	5910-679-9388	3-8	1A4A3A6C13
5910-678-5306	3-15	1A4A4C95	5910-679-9388	3-23	1A5A5C23
5910-678-5306	3-15	1A4A4C99	5910-679-9388	3-25	1A5A4C23
5910-678-5306	3-15	1A4A4C100	5910-679-9397	3-15	1A4A4C74
5910-678-5306	3-15	1A4A4C102	5910-679-9473	3-27	1A5A2C4
5910-678-5306	3-15	1A4A4C104	5910-679-9491	3-40	1A7A1C105
5910-678-5306	3-15	1A4A4C108	5910-679-9502	3-34	1A10C5
5910-678-5306	3-15	1A4A4C111	5910-681-2362	3-17	1A4A5C35
5910-678-5306	3-15	1A4A4C112	5910-681-7140		1A4A4C131
5910-678-5306	3-15	1A4A4C116	5910-681-7140	3-6	1A4A3C42
5910-678-5306	3-15	1A4A4C122	5910-681-7140	3-6	1A4A3C44
5910-678-5306	3-15	1A4A4C132	5910-681-7140	3-9	1A4A3A7C2
5910-678-5306	3-15	1A4A4C134	5910-681-7140	3-23	1A5A5C5
5910-678-5306	3-15	1A4A4C135	5910-681-7140	3-25	1A5A4C5
5910-678-5306	3-15	1A4A4C142	5910-681-7140	3-29	1A5A3A1C3
5910-678-5306	3-15	1A4A4C174	5910-681-7140	3-29	1A5A3A1C4

SECTION IV INDEX-FEDERAL STOCK NUMBER AND REFERENCE NUMBER CROSS REFERENCE  
 TO FIGURE AND ITEM NUMBER OR REFERENCE DESIGNATION (CONTINUED)

FEDERAL STOCK NUMBER	FIGURE NUMBER	ITEM NUMBER OR REF. DESIGNATION	FEDERAL STOCK NUMBER	FIGURE NUMBER	ITEM NUMBER OR REF. DESIGNATION
5910-681-7140	3-30	1A5A3A2C3	5910-686-6929	3-25	1A5A4C4
5910-681-7140	3-30	1A5A3A2C4	5910-686-6929	3-25	1A5A4C10
5910-681-7140	3-31	1A5A6C5	5910-686-6929	3-26	1A5A4C28
5910-681-7617	3-6	1A4A3C32	5910-686-6929	3-31	1A5A6C3
5910-681-7617	3-6	1A4A3C34	5910-686-6929	3-31	1A5A6C9
5910-683-7478	3-15	1A4A4C26	5910-686-6929	3-31	1A5A6C12
5910-683-7478	3-17	1A4A5C38	5910-686-6929	3-31	1A5A6C25
5910-683-7478	3-24	1A5A5C27	5910-686-7725	3-20	1A5A7C37
5910-683-7478	3-26	1A5A4C27	5910-686-7725	3-20	1A5A7C38
5910-683-7478	3-32	1A5A6C24	5910-686-9055	3-12	1A4A2C19
5910-683-7985	3-17	1A4A5C11	5910-688-2993	3-10	1A4A3A2C1
5910-683-7985	3-17	1A4A5C17	5910-688-2993	3-29	1A5A3A1C1
5910-683-7985	3-17	1A4A5C26	5910-688-2993	3-29	1A5A3A1C2
5910-683-7985	3-17	1A4A5C30	5910-688-2993	3-30	1A5A3A2C1
5910-683-8008	3-27	1A5A2C5	5910-688-2993	3-30	1A5A3A2C2
5910-685-9700	3-8	1A4A3A6C4	5910-688-6221	3-12	1A4A2C28
5910-686-6919	3-6	1A4A3C12	5910-688-8701	3-8	1A4A3A6C14
5910-686-6929	3-9	1A4A3A7C6	5910-702-7381	3-10	1A4A3A2C18
5910-686-6929	3-9	1A4A3A7C8	5910-702-7381	3-23	1A5A5C3
5910-686-6929	3-9	1A4A3A7C9	5910-702-7381	3-23	1A5A5C9
5910-686-6929	3-9	1A4A3A7C11	5910-702-7381	3-23	1A5A5C13
5910-686-6929	3-9	1A4A3A7C13	5910-702-7381	3-23	1A5A5C26
5910-686-6929	3-9	1A4A3A7C16	5910-702-7381	3-23	1A5A5C29
5910-686-6929	3-10	1A4A3A2C14	5910-702-7381	3-25	1A5A4C3
5910-686-6929	3-10	1A4A3A2C15	5910-702-7381	3-25	1A5A4C9
5910-686-6929	3-10	1A4A3A2C17	5910-702-7381	3-25	1A5A4C13
5910-686-6929	3-10	1A4A3A2C19	5910-702-7381	3-25	1A5A4C26
5910-686-6929	3-10	1A4A3A2C22	5910-702-7381	3-25	1A5A4C29
5910-686-6929	3-23	1A5A5C4	5910-702-7381	3-31	1A5A6C2
5910-686-6929	3-23	1A5A5C10	5910-702-7381	3-31	1A5A6C8
5910-686-6929	3-24	1A5A5C28	5910-702-7381	3-31	1A5A6C11

SECTION IV INDEX-FEDERAL STOCK NUMBER AND REFERENCE NUMBER CROSS REFERENCE  
TO FIGURE AND ITEM NUMBER OR REFERENCE DESIGNATION (CONTINUED)

FEDERAL STOCK NUMBER	FIGURE NUMBER	ITEM NUMBER OR REF. DESIGNATION	FEDERAL STOCK NUMBER	FIGURE NUMBER	ITEM NUMBER OR REF. DESIGNATION
5910-702-7381	3-31	1A5A6C21	5910-725-9294		1A4A4C85
5910-702-7381	3-31	1A5A6C23	5910-725-9294	3-6	1A4A3C46
5910-702-7381	3-31	1A5A6C26	5910-726-0474	3-8	1A4A3A6C3
5910-712-6931	3-24	1A5A5C15	5910-726-2448		1A4A3C43
5910-712-6931	3-26	1A5A4C15	5910-726-2448		1A4A3C45
5910-714-3977	3-40	1A7A1C101	5910-726-2448	3-6	1A4A3C41
5910-717-0167	3-53	1A6C19	5910-726-5239	3-6	1A4A3C22
5910-717-0167	3-53	1A6C22	5910-726-5239	3-6	1A4A3C38
5910-717-0169	3-7	1A4A3A3C10	5910-727-3991	3-29	1A5A3A1C5
5910-717-0169	3-17	1A4A5C6	5910-727-3991	3-30	1A5A3A2C5
5910-717-0169	3-17	1A4A5C8	5910-728-1577		1A4A4C86
5910-717-0169	3-17	1A4A5C12	5910-728-1577	3-7	1A4A3A3C8
5910-717-0169	3-17	1A4A5C25	5910-728-1577	3-8	1A4A3A6C6
5910-717-0169	3-17	1A4A5C33	5910-728-1577	3-17	1A4A5C38
5910-717-0169	3-28	1A5A2C15	5910-752-4615	3-6	1A4A3C7
5910-717-0169	3-29	1A5A3A1C5	5910-754-6495	3-12	1A4A2C21
5910-717-0169	3-30	1A5A3A2C5	5910-755-9120	3-57	1A2A2C1
5910-725-1993	3-7	1A4A3A3C11	5910-755-9291	3-54	1A6A1C4
5910-725-1993	3-9	1A4A3A7C5	5910-760-7919	3-10	1A4A3A2C34
5910-725-1993	3-9	1A4A3A7C10	5910-762-2945		1A4A4C82
5910-725-1993	3-9	1A4A3A7C14	5910-762-2945		1A4A5C38
5910-725-1993	3-10	1A4A3A2C13	5910-762-2945	3-6	1A4A3C24
			5910-762-2945	3-6	1A4A3C25
5910-725-1993	3-10	1A4A3A2C20	5910-764-1271	3-53	1A6C9
5910-725-1993	3-12	1A4A2C17	5910-765-6223	3-17	1A4A5C20
5910-725-1993	3-12	1A4A2C27	5910-765-6226	3-10	1A4A3A3C9
5910-725-1993	3-17	1A4A5C15	5910-766-8790		1A4A4C2
5910-725-1993	3-29	1A5A3A1C3	5910-766-8790		1A4A4C9
5910-725-1993	3-29	1A5A3A1C4	5910-766-8790		1A4A4C14
5910-725-1993	3-30	1A5A3A2C3	5910-766-8790		1A4A4C73
5910-725-1993	3-30	1A5A3A2C4	5910-766-8790	3-15	1A4A4C121

SECTION IV INDEX-FEDERAL STOCK NUMBER AND REFERENCE NUMBER CROSS REFERENCE  
TO FIGURE AND ITEM NUMBER OR REFERENCE DESIGNATION (CONTINUED)

FEDERAL STOCK NUMBER	FIGURE NUMBER	ITEM NUMBER OR REF. DESIGNATION	FEDERAL STOCK NUMBER	FIGURE NUMBER	ITEM NUMBER OR REF. DESIGNATION
5910-766-8790	3-15	1A4A4C180	5910-804-7566		1A2A2C8
5910-766-8790	3-17	1A4A5C9	5910-804-7566		1A2A2C9
5910-766-8790	3-29	1A5A3A1C5	5910-804-7566		1A2A2C10
5910-766-8790	3-30	1A5A3A2C5	5910-806-3412	3-53	1A6C20
5910-771-5605	3-12	1A4A2C5	5910-810-8264	3-23	1A5A5C8
5910-771-9090	3-17	1A4A5C20	5910-810-8264	3-25	1A5A4C8
5910-772-1217	3-29	1A5A3A1C5	5910-810-8264	3-29	1A5A3A1C5
5910-772-1217	3-30	1A5A3A2C5	5910-810-8264	3-30	1A5A3A2C5
5910-777-6907	3-17	1A4A5C20	5910-810-8264	3-31	1A5A6C6
5910-777-6919	3-17	1A4A5C20	5910-811-5919	3-23	1A5A5C8
5910-777-6922	3-17	1A4A5C20	5910-811-5919	3-25	1A5A4C8
5910-781-7929	3-23	1A5A5C8	5910-811-5919	3-31	1A5A6C6
5910-781-7929	3-25	1A5A4C8	5910-812-4062	3-53	1A6C3
5910-781-7929	3-31	1A5A6C6	5910-813-0406	3-5	1A4A1C16
5910-781-7930	3-31	1A5A6C6	5910-814-6449		1A2A1C5
5910-800-0357	3-6	1A4A3C2	5910-814-6449		1A2A1C6
5910-800-0357	3-6	1A4A3C39	5910-814-9529	3-37	1A3C32
5910-800-0357	3-23	1A5A5C2	5910-815-3907	3-37	1A3C54
5910-800-0357	3-23	1A5A5C7	5910-815-3907	3-37	1A3C55
5910-800-0357	3-25	1A5A4C2	5910-816-0334	3-35	1A12C1
5910-800-0357	3-31	1A5A6C1	5910-816-0334	3-35	1A12C2
5910-800-0357	3-31	1A5A6C7	5910-816-8410	3-17	1A4A5C37
5910-803-2882	3-2	1A4C21	5910-816-9838		1A2A1C3
5910-803-2882	3-2	1A4C22	5910-816-9838		1A2A1C4
5910-803-2882	3-2	1A4C29	5910-818-0412	3-37	1A3C29
5910-803-2882	3-2	1A4C30	5910-819-1784		1A4A4C28
5910-803-2882	3-2	1A4C33	5910-819-1784	3-12	1A4A2C26
5910-803-2882	3-2	1A4C37	5910-819-7095	3-37	1A3C52
5910-803-2882	3-2	1A4C40	5910-819-8244	3-15	1A4A4C66
5910-803-2882	3-6	1A4A3C19	5910-819-8244	3-15	1A4A4C70
5910-804-7566		1A2A2C7	5910-822-5233		1A4A3C43

SECTION IV INDEX-FEDERAL STOCK NUMBER AND REFERENCE NUMBER CROSS REFERENCE  
 TO FIGURE AND ITEM NUMBER OR REFERENCE DESIGNATION (CONTINUED)

FEDERAL STOCK NUMBER	FIGURE NUMBER	ITEM NUMBER OR REF. DESIGNATION	FEDERAL STOCK NUMBER	FIGURE NUMBER	ITEM NUMBER OR REF. DESIGNATION
5910-822-5233	3-10	1A4A3A2C2	5910-823-1087		1A4A3A2C35
5910-822-5233	3-10	1A4A3A2C7	5910-823-1087		1A4A3A2C36
5910-822-5683		1A8C2	5910-823-1308	3-6	1A4A3C33
5910-822-5683	3-37	1A3C51	5910-823-1308	3-6	1A4A3C6
5910-822-5683	3-38	1A3C1	5910-823-1308	3-15	1A4A4C48
5910-822-5683	3-38	1A3C36	5910-824-8236	3-15	1A4A4C139
5910-822-5683	3-38	1A3C37	5910-824-8236	3-15	1A4A4C144
5910-822-5683	3-48	1A8C1	5910-824-8236	3-15	1A4A4C145
5910-822-7335	3-10	1A4A3A2C12	5910-824-9417	3-15	1A4A4C27
5910-823-1068	3-53	1A6C17	5910-825-3252	3-5	1A4A1C1
5910-823-1068	3-54	1A6A1C5	5910-825-3252	3-5	1A4A1C6
5910-823-1077		1A4A3A2C35	5910-832-5724		1A4A4C64
5910-823-1077		1A4A3A2C36	5910-832-5724	3-6	1A4A3C8
5910-823-1078	3-10	1A4A3A2C26	5910-832-5724	3-12	1A4A2C22
5910-823-1078	3-10	1A4A3A2C27	5910-835-2175	3-5	1A4A1C12
5910-823-1079	3-10	1A4A3A2C26	5910-835-2175	3-19	1A5A1C3
5910-823-1079	3-10	1A4A3A2C27	5910-835-2175	3-19	1A5A1C5
5910-823-1080	3-10	1A4A3A2C26	5910-835-2175	3-23	1A5A5C1
5910-823-1080	3-10	1A4A3A2C27	5910-835-2175	3-23	1A5A5C6
5910-823-1081	3-10	1A4A3A2C26	5910-835-2175	3-23	1A5A5C12
5910-823-1081	3-10	1A4A3A2C27	5910-835-2175	3-23	1A5A5C18
5910-823-1082		1A4A3A2C35	5910-835-2175	3-25	1A5A4C1
5910-823-1082		1A4A3A2C36	5910-835-2175	3-25	1A5A4C6
5910-823-1083		1A4A3A2C35	5910-835-2175	3-25	1A5A4C12
5910-823-1083		1A4A3A2C36	5910-835-2175	3-25	1A5A4C18
5910-823-1084		1A4A3A2C35	5910-835-2175	3-31	1A5A6C4
5910-823-1084		1A4A3A2C36	5910-835-2175	3-31	1A5A6C27
5910-823-1085		1A4A3A2C35	5910-836-0412	3-10	1A4A3A2C5
5910-823-1085		1A4A3A2C36	5910-836-0412	3-10	1A4A3A2C6
5910-823-1086		1A4A3A2C35	5910-836-0412	3-10	1A4A3A2C37
5910-823-1086		1A4A3A2C36	5910-836-1289	3-19	1A5A1C4

SECTION IV INDEX-FEDERAL STOCK NUMBER AND REFERENCE NUMBER CROSS REFERENCE  
TO FIGURE AND ITEM NUMBER OR REFERENCE DESIGNATION (CONTINUED)

FEDERAL STOCK NUMBER	FIGURE NUMBER	ITEM NUMBER OR REF. DESIGNATION	FEDERAL STOCK NUMBER	FIGURE NUMBER	ITEM NUMBER OR REF. DESIGNATION
5910-837-5109	3-38	1A3C41	5910-849-5725	3-17	1A4A5C36
5910-837-5109	3-38	1A3C43	5910-849-5727	3-17	1A4A5C5
5910-837-5109	3-38	1A3C44	5910-849-5727	3-17	1A4A5C29
5910-837-5109	3-38	1A3C48	5910-849-5727	3-17	1A4A5C34
5910-837-5677	3-12	1A4A2C26	5910-849-5727	3-17	1A4A5C38
5910-838-3556	3-37	1A3C50	5910-849-7257	3-10	1A4A3A2C28
5910-838-4860	3-37	1A3C70	5910-850-0541		1A4A4C33
5910-838-9421	3-10	1A4A3A2C29	5910-850-0541	3-15	1A4A4C12
5910-838-9421	3-10	1A4A3A2C30	5910-850-0541	3-17	1A4A5C31
5910-838-9421	3-38	1A3C2	5910-850-0541	3-38	1A3C16
5910-838-9421	3-38	1A3C3	5910-850-9066	3-6	1A4A3C11
5910-838-9421	3-38	1A3C6	5910-850-9074	3-10	1A4A3A2C32
5910-846-4858	3-37	1A3C49	5910-850-9074	3-10	1A4A3A2C33
5910-847-7288	3-6	1A4A3C44	5910-850-9074	3-12	1A4A2C1
5910-847-7288	3-7	1A4A3A3C1	5910-851-0687	3-54	1A6A1C6
5910-847-7288	3-7	1A4A3A3C3	5910-851-0687	3-54	1A6A1C9
5910-847-7288	3-7	1A4A3A3C6	5910-851-0687	3-54	1A6A1C10
5910-847-7288	3-7	1A4A3A3C7	5910-854-8543	3-23	1A5A5C8
5910-849-0714	3-27	1A5A2C3	5910-854-8543	3-25	1A5A4C8
5910-849-0714	3-29	1A5A3A1C3	5910-854-8543	3-29	1A5A3A1C5
5910-849-0714	3-29	1A5A3A1C4	5910-854-8543	3-30	1A5A3H2C5
5910-849-0714	3-30	1A5A3A2C3	5910-854-8543	3-31	1A5A6C6
5910-849-0714	3-30	1A5A3A2C4	5910-860-7747	3-17	1A4A5C3
5910-849-5725		1A4A5C4	5910-871-6504	3-57	1A2A2S1
5910-849-5725	3-17	1A4A5C1	5910-893-8875	3-15	1A4A4C75
5910-849-5725	3-17	1A4A5C7	5910-893-8875	3-15	1A4A4C76
5910-849-5725	3-17	1A4A5C10	5910-893-8953	3-15	1A4A4C32
5910-849-5725	3-17	1A4A5C13	5910-893-8953	3-15	1A4A4C37
5910-849-5725	3-17	1A4A5C14	5910-893-8953	3-15	1A4A4C38
5910-849-5725	3-17	1A4A5C16	5910-893-9766	3-17	1A4A5C35
5910-849-5725	3-17	1A4A532	5910-894-0917	3-6	1A4A3C27

SECTION IV INDEX-FEDERAL STOCK NUMBER AND REFERENCE NUMBER CROSS REFERENCE  
TO FIGURE AND ITEM NUMBER OR REFERENCE DESIGNATION (CONTINUED)

FEDERAL STOCK NUMBER	FIGURE NUMBER	ITEM NUMBER OR REF. DESIGNATION	FEDERAL STOCK NUMBER	FIGURE NUMBER	ITEM NUMBER OR REF. DESIGNATION
5910-899-3164		1A3C12	5910-899-6542		1A12C35
5910-899-6542		1A12C5	5910-899-6542		1A12C36
5910-899-6542		1A12C6	5910-899-6542		1A12C37
5910-899-6542		1A12C7	5910-899-6542		1A12C38
5910-899-6542		1A12C8	5910-899-6542		1A12C39
5910-899-6542		1A12C9	5910-899-6542		1A12C40
5910-899-6542		1A12C10	5910-899-6542		1A12C41
5910-899-6542		1A12C11	5910-899-6542		1A12C42
5910-899-6542		1A12C12	5910-899-6542		1A12C43
5910-899-6542		1A12C13	5910-899-6542		1A12C44
5910-899-6542		1A12C14	5910-899-6542		1A12C45
5910-899-6542		1A12C15	5910-899-6542		1A12C46
5910-899-6542		1A12C16	5910-899-6542		1A12C47
5910-899-6542		1A12C17	5910-899-6542		1A12C48
5910-899-6542		1A12C18	5910-899-8127	3-5	1A4A1C5
5910-899-6542		1A12C19	5910-901-8796	3-12	1A4A2C13
5910-899-6542		1A12C20	5910-901-8796	3-14	1A4A4C171
5910-899-6542		1A12C21	5910-902-2360		1A6C6
5910-899-6542		1A12C22	5910-902-4551		1A4A3A3C14
5910-899-6542		1A12C23	5910-902-4551		1A4A3A3C17
5910-899-6542		1A12C24	5910-902-4551		1A4A3A6C17
5910-899-6542		1A12C25	5910-902-4551	3-8	1A4A3A6C14
5910-899-6542		1A12C26	5910-903-6951		1A4A3A2C35
5910-899-6542		1A12C27	5910-903-6951		1A4A3A2C36
5910-899-6542		1A12C28	5910-903-9880	3-29	1A5A3A1C3
5910-899-6542		1A12C29	5910-903-9880	3-29	1A5A3A1C4
5910-899-6542		1A12C30	5910-903-9880	3-30	1A5A3A2C3
5910-899-6542		1A12C31	5910-903-9880	3-30	1A5A3A2C4
5910-899-6542		1A12C32	5910-904-2921		1A4A3A3C6
5910-899-6542		1A12C33	5910-904-2921		1A4A3A3C7
5910-899-6542		1A12C34	5910-904-2921		1A4A3A3C11



SECTION IV INDEX-FEDERAL STOCK NUMBER AND REFERENCE NUMBER CROSS REFERENCE  
TO FIGURE AND ITEM NUMBER OR REFERENCE DESIGNATION (CONTINUED)

FEDERAL STOCK NUMBER	FIGURE NUMBER	ITEM NUMBER OR REF. DESIGNATION	FEDERAL STOCK NUMBER	FIGURE NUMBER	ITEM NUMBER OR REF. DESIGNATION
5910-913-6383	3-37	1A3C21	5910-952-9257	3-17	1A4A5C19
5910-913-6383	3-37	1A3C25	5910-954-5504	3-23	1A5A5C8
5910-913-6383	3-37	1A3C26	5910-954-5504	3-25	1A5A4C8
5910-913-6383	3-37	1A3C27	5910-960-7347	3-29	1A5A3A1C5
5910-913-6383	3-37	1A3C28	5910-960-7347	3-30	1A5A3A2C5
5910-919-3952	3-54	1A6A1C10	5910-978-0993		1A4A3C41
5910-925-8882	3-37	1A3C53	5910-978-0993		1A4A3C42
5910-926-9776	3-12	1A4A2C26	5910-978-6417	3-12	1A4A2C3
5910-927-2735	3-5	1A4A1C3	5910-978-6417	3-12	1A4A2C9
5910-932-2738	3-6	1A4A3C4	5910-978-6417	3-12	1A4A2C20
5910-932-2738	3-6	1A4A3C40	5910-984-4144		1A5A3A1C3
5910-932-2738	3-9	1A4A3A7C1	5910-984-4144		1A5A3A1C4
5910-936-1522	3-9	1A4A3A7C7	5910-984-4144		1A5A3A2C3
5910-936-1522	3-9	1A4A3A7C12	5910-984-4144		1A5A3A2C4
5910-936-1522	3-9	1A4A3A7C15	5910-984-4144	3-19	1A5A1C1
5910-936-1522	3-10	1A4A3A2C8	5910-984-5253		1A4A4C118
5910-936-1522	3-10	1A4A3A2C10	5910-984-5253		1A4A4C119
5910-936-7370		1A4A4C148	5910-984-5253	3-15	1A4A4C177
5910-936-7370	3-15	1A4A4C93	5910-984-5253	3-17	1A4A5C38
5910-938-1013	3-37	1A3C8	5910-984-5253	3-24	1A5A5C25
5910-939-7510		1A5A4C30	5910-984-5253	3-26	1A5A4C25
5910-939-7510		1A5A5C30	5910-984-5253	3-32	1A5A6C14
5910-939-7510		1A5A6C28	5910-984-5253	3-32	1A5A6C22
5910-939-7510		1A5A6C30	5910-984-5253	3-38	1A3C19
5910-949-7366	3-2	1A4C34	5910-984-8375	3-12	1A4A2C4
5910-949-7366	3-2	1A4C43	5910-984-8375	3-12	1A4A2C18
5910-951-2415	3-6	1A4A3C26	5910-988-4314	3-29	1A5A3A1C5
5910-951-6723	3-29	1A5A3A1C3	5910-988-4314	3-30	1A5A3A2C5
5910-951-6723	3-29	1A5A3A1C4	5910-988-4718		1A4A4C184
5910-951-6723	3-30	1A5A3A2C3	5910-988-7897		1A4A4C59
5910-951-6723	3-30	1A5A3A2C4	5910-988-7897		1A4A4C186
5910-952-9257	3-17	1A4A5C18	5910-990-4111	3-28	1A5A2C10

SECTION IV INDEX-FEDERAL STOCK NUMBER AND REFERENCE NUMBER CROSS REFERENCE  
 TO FIGURE AND ITEM NUMBER OR REFERENCE DESIGNATION (CONTINUED)

FEDERAL STOCK NUMBER	FIGURE NUMBER	ITEM NUMBER OR REF. DESIGNATION	FEDERAL STOCK NUMBER	FIGURE NUMBER	ITEM NUMBER OR REF. DESIGNATION
5910-990-5413	3-23	1A5A5C8	5915-828-9058		1A4A3A3FL2
5910-990-5413	3-25	1A5A4C8	5915-863-5932	3-12	1A4A2FL1
5910-990-5413	3-29	1A5A3A1C5	5920-027-0801	3-36	1A3XF1
5910-990-5413	3-30	1A5A3A2C5	5920-243-3788	3-35	1A12F1
5910-990-5413	3-31	1A5A6C6	5920-280-4465	3-36	1A3F1
5910-990-6293	3-51	1A9C1	5920-280-4465	3-44	1A7A4F201
5910-990-6293	3-51	1A9C2	5920-281-0224	3-36	1A3F1
5910-990-6796	3-38	1A3C15	5920-518-1793	3-33	1A10F1
5910-992-2070	3-24	1A5A5C21	5920-519-7733	3-35	1A12F1
5910-992-2070	3-24	1A5A5C22	5920-552-0269	3-49	1A1XF1
5910-992-2070	3-26	1A5A4C21	5920-552-0269	3-49	1A1XF2
5910-992-2070	3-26	1A5A4C22	5920-636-0957	3-35	1A12F3
5910-992-2070	3-32	1A5A6C18	5920-655-4133	3-33	1A10XF1
5910-992-2070	3-32	1A5A6C19	5920-655-4133	3-35	1A12XF1
5910-993-0098	3-29	1A5A3A1C3	5920-655-4133	3-46	1A11XF1
5910-993-0098	3-29	1A5A3A1C4	5920-669-6859	3-35	1A12F2
5910-993-0098	3-30	1A5A3A2C3	5920-686-0025		1A13F1
5910-993-0098	3-30	1A5A3A2C4	5920-686-0025		1A13F2
5910-993-2380		1A4A4C88	5920-811-7678	3-34	1A10TB1
5910-993-2380	3-15	1A4A4C46	5920-850-6091		1A11F1
5910-998-1606		1A2A1C1	5920-855-4260		1A11F1
5910-998-1606		1A2A1C2	5920-929-1999		1A7A4E201
5915-583-1963	3-9	1A4A3A7FL1	5930-050-2680	3-21	1A5A7S4
5915-383-1964	3-25	1A5A4FL1	5930-050-2681	3-36	1A3S3
5915-583-1964	3-30	1A5A3A2FL1	5930-050-2681	3-36	1A3S2
5915-615-0565	3-31	1A5A6FL1	5930-060-2226	3-57	1A2S3B
5915-615-3952	3-23	1A5A5FL1	5930-060-2227	3-57	1A2S3A
5915-615-3952	3-29	1A5A3A1FL1	5930-078-2755	3-55	1A13A3S1
5915-679-9363	3-6	1A4A3FL1	5930-108-6980	3-52	1A6S4
5915-679-9383	3-7	1A4A3A3FL1	5930-239-9088	3-37	1A3S8
5915-679-9390	3-8	1A4A3A6FL1	5930-269-9610		1A12MP1

SECTION IV INDEX-FEDERAL STOCK NUMBER AND REFERENCE NUMBER CROSS REFERENCE  
 TO FIGURE AND ITEM NUMBER OR REFERENCE DESIGNATION (CONTINUED)

FEDERAL STOCK NUMBER	FIGURE NUMBER	ITEM NUMBER OR REF. DESIGNATION	FEDERAL STOCK NUMBER	FIGURE NUMBER	ITEM NUMBER OR REF. DESIGNATION
59300-548-8338	3-35	1A12S1	5930-726-2067	3-17	1A4A5CB1
5930-577-0135	3-3	1A4S2	5930-755-5834	3-26	1A3S1
5930-615-7897	3-36	1A3S9	5930-755-5835	3-38	1A3S4
5930-629-8335	3-14	1A4A4S8	5930-797-7838	3-38	1A3S11
5930-629-8337	3-14	1A4A4S12	5930-797-7838	3-38	1A3S12
5930-629-8339	3-14	1A4A4S1	5930-823-0146	3-49	1A1S1
5930-636-1584	3-38	1A3S10	5930-901-1782	3-21	1A5A7S1
5930-655-1223	3-52	1A6S3	5935-057-2690	3-14	1A4A4P1
5930-655-1508	3-21	1A5A7S5	5935-057-2690	3-23	1A5A5P1
5930-655-1508	3-57	1A2S2	5935-057-2690	3-25	1A5A4P1
5930-655-1582	3-33	1A10S1	5935-057-2690	3-31	1A5A6P1
5930-678-4050	3-57	1A2A2S2	5935-057-7591	3-14	1A4A4P2
5930-678-4052	3-57	1A2S1	5935-204-5833	3-46	1A11J1
5930-678-5336	3-53	1A6S1	5935-204-7705	3-2	1A4J17
5930-678-5337	3-53	1A6S2	5935-204-7705	3-38	1A3J6
5930-679-9336		1A3MP5	5935-204-7705	3-43	1A7J8
5930-679-9340	3-37	1A3S7	5935-222-9828	3-16	1A4A4XV1
5930-679-9349	3-3	1A4S1	5935-222-9828	3-16	1A4A4XV3
5930-679-9411	3-14	1A4A4S6	5935-222-9828	3-16	1A4A4XV6
5930-679-9411	3-14	1A4A4S9	5935-222-9828	3-53	1A6XV1
5930-679-9460	3-21	1A5A7S2	5935-222-9828	3-53	1A6XV2
5930-679-9487	3-43	1A7S1	5935-230-1561	3-50	1A9J1
5930-679-9487	3-47	1A8S1	5935-232-3758	3-6	1A4A3XV1
5930-679-9498	3-51	1A9S1	5935-232-3758	3-6	1A4A3XV2
5930-679-9507	3-46	1A11S1	5935-232-3758	3-6	1A4A3XV3
5930-686-2648	3-37	1A3S5	5935-257-8683	3-6	1A4A3J7
5930-687-1886	3-6	1A4A3J4	5935-260-0516	3-48	1A8XV1
5930-687-1886	3-6	1A4A3J5	5935-260-0516	3-48	1A8XV2
5930-687-1886	3-6	1A4A3J6	5935-283-1269	3-42	1A7J6
5930-687-1886	3-6	1A4A3J8			
5930-687-1886	3-6	1A4A3J9			

SECTION IV INDEX-FEDERAL STOCK NUMBER AND REFERENCE NUMBER CROSS REFERENCE  
 TO FIGURE AND ITEM NUMBER OR REFERENCE DESIGNATION (CONTINUED)

FEDERAL STOCK NUMBER	FIGURE NUMBER	ITEM NUMBER OR REF. DESIGNATION	FEDERAL STOCK NUMBER	FIGURE NUMBER	ITEM NUMBER OR REF. DESIGNATION
5935-283-2910		1A13A2W1P1	5935-577-8713	3-1	1A4J6
5935-283-2910		1A13A2W1P2	5935-577-8713	3-20	1A5A7J3
5935-283-2910	3-58	1A2P4	5935-577-8713	3-20	1A5A7J4
5935-284-3931	3-35	1A12J1	5935-577-8713	3-20	1A5A7J6
5935-284-3931	3-38	1A3J3	5935-577-8713	3-20	1A5A7J7
5935-296-8720	3-2	1A4J16	5935-577-8776		1A14P1
5935-296-8720	3-43	1A7J9	5935-577-8776		1A14P2
5935-296-8771		1A13A2W11P1	5935-577-8776		1A2P5
5935-296-8771		1A13A2W17P1	5935-577-8776	3-58	1A2P3
5935-296-8771		1A13A2W19P1	5935-581-1811		1A13A2W9P1
5935-296-8792		1A13A2W16P1	5935-581-1811		1A13A2W9P2
5935-296-8792		1A13A2W18P1	5935-615-2183	3-12	1A4A2XY1
5935-296-8792		1A13A2W22P1	5935-615-3914	3-5	1A4A1J1
5935-296-8792		1A13A2W24P1	5935-615-3914	3-5	1A4A1J2
5935-502-7716		1A13A2W14P1	5935-615-3914	3-5	1A4A1J3
5935-504-3161	3-22	1A5A7J12	5935-615-3914	3-19	1A5A1J1
5935-504-3161	3-34	1A10J1	5935-615-3914	3-19	1A5A1J2
5935-504-3161	3-51	1A9J3	5935-615-3914	3-29	1A5A3A1J1
5935-504-3161	3-58	1A2J8	5935-615-3914	3-29	1A5A3A1J2
5935-518-7419	3-22	1A5A7J13	5935-615-3914	3-30	1A5A3A2J1
5935-518-7419	3-34	1A10J2	5935-615-3914	3-30	1A5A3A2J2
5935-518-8696	3-42	1A7J5	5935-615-8555		1A4A4J16
5935-538-3069	3-6	1A4A3E30	5935-615-8555	3-6	1A4A3J3
5935-538-3069	3-14	1A4A4E22	5935-615-8555	3-6	1A4A3J12
5935-538-3069	3-47	1A8J3	5935-615-8555	3-6	1A4A3J13
5935-539-0851		1A2J9	5935-615-8555	3-9	1A4A3A7J1
5935-543-8640		1A13A2W26P1	5935-615-8555	3-9	1A4A3A7J2
5935-552-3850	3-6	1A4A3J1	5935-615-8555	3-10	1A4A3A2J1
5935-577-8713	3-2	1A4J3	5935-615-8555	3-10	1A4A3A2J2
5935-577-8713	3-2	1A4J4	5935-615-8555	3-14	1A4A4J1
5935-577-8713	3-2	1A4J5	5935-615-8555	3-14	1A4A4J3

SECTION IV INDEX-FEDERAL STOCK NUMBER AND REFERENCE NUMBER CROSS REFERENCE  
TO FIGURE NUMBER OR REFERENCE DESIGNATION (CONTINUED)

FEDERAL STOCK NUMBER	FIGURE NUMBER	ITEM NUMBER OR REF. DESIGNATION	FEDERAL STOCK NUMBER	FIGURE NUMBER	ITEM NUMBER OR REF. DESIGNATION
5935-615-8555	3-14	1A4A4J5	5935-729-7312	3-6	1A4A3XV4
5935-615-8555	3-14	1A4A4J6	5935-729-7312	3-20	1A5A7XV1
5935-615-8555	3-14	1A4A4J7	5935-729-7312	3-38	1A3XV1
5935-615-8555	3-14	1A4A4J8	5935-729-7312	3-38	1A3XV2
5935-615-8555	3-14	1A4A4J9	5935-729-8618	3-53	1A6J1
5935-615-8555	3-14	1A4A4J10	5935-810-3767	3-38	1A3J1
5935-615-8555	3-14	1A4A4J11	5935-810-3767	3-49	1A1J1
5935-615-8555	3-14	1A4A4J12	5935-816-9923	3-41	1A7A1XQ101
5935-615-8555	3-14	1A4A4J13	5935-835-0508		1A1P3
5935-615-8555	3-14	1A4A4J14	5935-835-0508		1A1P4
5935-615-8555	3-14	1A4A4J15	5935-835-0508		1A1P5
5935-615-8555	3-16	1A4A4J2	5935-835-0508		1A1P6
5935-615-8555	3-16	1A4A4J4	5935-835-0508		1A13A2W2P1
5935-617-6837	3-6	1A4A3J2	5935-835-0508		1A13A2W2P2
5935-617-6837	3-36	1A3J4	5935-835-0508		1A13A2W3P1
5935-651-2698	3-6	1A4A3E22	5935-835-0508		1A13A2W3P2
5935-655-0724		1A13A2W12P1	5935-835-0508		1A13A2W4P1
5935-655-0724		1A13A2W15P1	5935-835-0508		1A13A2W4P2
5935-655-0725		1A13A2W21P1	5935-835-0508		1A13A2W5P1
5935-655-0725		1A13A2W23P1	5935-835-0508		1A13A2W5P2
5935-655-3355		1A13A2W13P1	5935-835-0508		1A13A2W6P1
5935-655-3355		1A13A2W20P1	5935-835-0508		1A13A2W6P2
5935-660-3558	3-20	1A5A7J5	5935-835-0508		1A13A2W7P1
5935-681-4305	3-22	1A5A7J11	5935-835-0508		1A13A2W7P2
5935-681-4305	3-48	1A8J4	5935-835-0508		1A13A2W8P1
5935-683-7657	3-36	1A3J5	5935-835-0508		1A13A2W8P2
5935-683-7892		1A13A2CP1	5935-835-0508		1A13A2W10P1
5935-686-3635	3-6	1A4A3P1	5935-835-0508		1A13A2W10P2
5935-722-3190		1A13A2W1P1	5935-835-0508		1A13A2W27P1
5935-722-3190		1A13A2W1P2	5935-835-0508		1A13A2W27P2
5935-722-3190	3-58	1A2P4	5935-840-5485	3-37	1A3XK1

SECTION IV INDEX-FEDERAL STOCK NUMBER AND REFERENCE NUMBER CROSS REFERENCE  
TO FIGURE AND ITEM NUMBER OR REFERENCE DESIGNATION (CONTINUED)

FEDERAL STOCK NUMBER	FIGURE NUMBER	ITEM NUMBER OR REF. DESIGNATION	FEDERAL STOCK NUMBER	FIGURE NUMBER	ITEM NUMBER OR REF. DESIGNATION
5935-853-7596			5935-974-5418		
5935-853-7596	3-2	1A4J10	5935-974-5418	3-58	1A2A2J4
5935-853-7596	3-2	1A4J11	5935-987-3551	3-38	1A3XV3
5935-853-7596	3-2	1A4J12	5935-987-3551	3-38	1A3XV4
5935-853-7596	3-2	1A4J13	5935-989-4399	3-2	1A4J1
5935-853-7596	3-2	1A4J14	5935-989-4399	3-2	1A4J7
5935-853-7596	3-2	1A4J15	5935-993-2181	3-2	1A4J2
5935-853-7596	3-22	1A5A7J8	5935-993-2181	3-20	1A5A7J1
5935-853-7596	3-22	1A5A7J9	5935-993-2181	3-20	1A5A7J2
5935-853-7596	3-22	1A5A7J10	5935-993-2181	3-20	1A5A7J14
5935-853-7596	3-43	1A7J7	5940-782-8942	3-17	1A4A5E1
5935-853-7596	3-48	1A8J1	5940-782-8942	3-17	1A4A5E3
5935-853-7596	3-48	1A8J2	5940-782-8942	3-17	1A4A5E4
5935-853-7596	3-49	1A1J2	5940-782-8942	3-17	1A4A5E7
5935-853-7596	3-51	1A9J2	5940-782-8942	3-17	1A4A5E9
5935-853-7596	3-53	1A6J2	5940-782-8942	3-17	1A4A5E10
5935-853-7596	3-53	1A6J3	5940-854-8717		1A1E3
5935-961-5106	3-16	1A4A4XV2	5940-854-8717		1A1E4
5935-961-5106	3-16	1A4A4XV4	5940-854-8717		1A1E5
5935-961-5106	3-16	1A4A4XV5	5945-080-5561	3-12	1A4A2K1
5935-961-5106	3-16	1A4A4XV7	5945-080-5561	3-12	1A4A2K2
5935-961-5106	3-16	1A4A4XV8	5945-230-2105	3-37	1A3K2
5935-961-5106	3-16	1A4A4XV9	5945-232-7665	3-35	1A12K1
5935-961-5106	3-16	1A4A4XV10	5945-259-0984	3-38	1A3K1
5935-974-5418	3-38	1A3J2	5945-448-5833	3-49	1A1K2
5935-974-5418	3-56	1A14J1	5945-448-5836	3-49	1A1K1
5935-974-5418	3-58	1A2J1	5945-542-7041	3-2	1A4K1
5935-974-5418	3-58	1A2J2	5945-542-7041	3-16	1A4A4K2
5935-974-5418	3-58	1A2J9	5945-577-7273	3-14	1A4A4K1
5935-974-5418	3-58	1A2J10	5945-679-9456	3-20	1A5A7K1
5935-974-5418	3-58	1A2J11	5945-679-9457	3-20	1A5A7K2

SECTION IV INDEX-FEDERAL STOCK NUMBER AND REFERENCE NUMBER CROSS REFERENCE  
 TO FIGURE AND ITEM NUMBER OR REFERENCE DESIGNATION (CONTINUED)

FEDERAL STOCK NUMBER	FIGURE NUMBER	ITEM NUMBER OR REF. DESIGNATION	FEDERAL STOCK NUMBER	FIGURE NUMBER	ITEM NUMBER OR REF. DESIGNATION
5945-679-9554	3-38	1A3K3	5950-583-0918	3-25	1A5A4T4
5945-679-9554	3-43	1A7K1	5950-583-0918	3-31	1A5A6T5
5945-679-9554	3-53	1A6K1	5950-583-0919	3-23	1A5A5T1
5945-740-2595	3-51	1A9K1	5950-583-0919	3-25	1A5A4T1
5950-044-5027	3-10	1A4A3A2T2	5950-583-0919	3-31	1A5A6T1
5950-044-5027	3-10	1A4A3A2T3	5950-583-0919	3-31	1A5A6T2
5950-055-9626	3-23	1A5A5T2	5950-583-0922	3-7	1A4A3A3T1
5950-055-9626	3-25	1A5A4T2	5950-583-0950	3-23	1A5A5L1
5950-080-5710	3-31	1A5A6T3	5950-583-0950	3-25	1A5A4L1
5950-237-1531		1A2A1L1	5950-583-0950	3-31	1A5A6L1
5950-237-1531		1A2A1L2	5950-583-0953	3-37	1A3L9
5950-237-1531	3-38	1A3L5	5950-583-0966	3-17	1A4A5T2
5950-237-1531	3-38	1A3L6	5950-583-0976		1A7L1
5950-237-1531	3-38	1A3L7	5950-583-0976	3-42	1A7L2
5950-279-2658	3-25	1A5A4R6	5950-583-0981	3-19	1A5A1T1
5950-387-0489	3-17	1A4A5L2	5950-583-0982	3-8	1A4A3A6T1
5950-387-0489	3-17	1A4A5L3	5950-583-0999	3-29	1A5A3A1T1
5950-444-8793	3-10	1A4A3A2L1	5950-583-0999	3-30	1A5A3A2T1
5950-444-8793	3-10	1A4A3A2L2	5950-594-1217		1A4A4L33
5950-474-5716	3-10	1A4A3A2T1	5950-594-1217	3-5	1A4A1L1
5950-474-6346	3-10	1A4A3A2T4	5950-594-1217	3-14	1A4A4L32
5950-505-0259	3-42	1A7T6	5950-594-1217	3-17	1A4A5L6
5950-519-8787	3-51	1A9T1	5950-594-1217	3-29	1A5A3A1L1
5950-583-0904		1A4A3A8E23	5950-594-1217	3-29	1A5A3A1L2
5950-583-0904		1A4A3A8E24	5950-594-1217	3-30	1A5A3A2L1
5950-583-0904		1A4A3A8E25	5950-594-1217	3-30	1A5A3A2L2
5950-583-0904		1A4A3A8E26	5950-615-0595	3-9	1A4A3A7L2
5950-583-0904		1A4A3A8E27	5950-615-0595	3-10	1A4A3A2L3
5950-583-0904	3-13	1A4A4E24	5950-615-0596	3-6	1A4A3L3
5950-583-0917	3-19	1A5A1T2	5950-615-0606	3-27	1A5A2L4
5950-583-0918	3-23	1A5A5T4	5950-615-0607	3-37	1A3L8

SECTION IV INDEX-FEDERAL STOCK NUMBER AND REFERENCE NUMBER CROSS REFERENCE  
TO FIGURE AND ITEM NUMBER OR REFERENCE DESIGNATION (CONTINUED)

FEDERAL STOCK NUMBER	FIGURE NUMBER	ITEM NUMBER OR REF. DESIGNATION	FEDERAL STOCK NUMBER	FIGURE NUMBER	ITEM NUMBER OR REF. DESIGNATION
5950-615-0727	3-24	1A5A5T3	5950-679-9461	3-20	1A5A7T2
5950-615-0727	3-26	1A5A4T3	5950-679-9461	3-20	1A5A7T3
5950-615-0727	3-32	1A5A6T4	5950-679-9461	3-20	1A5A7T4
5950-615-4792	3-17	1A4A5T3	5950-679-9461	3-42	1A7T2
5950-615-5029	3-9	1A4A3A7T1	5950-679-9461	3-42	1A7T3
5950-615-9619	3-9	1A4A3A7L1	5950-679-9488	3-42	1A7T1
5950-615-9619	3-10	1A4A3A2L4	5950-679-9488	3-42	1A7T4
5950-617-8693	3-5	1A4A1T3	5950-679-9488	3-42	1A7T5
5950-617-8694	3-5	1A4A1T1	5950-679-9488	3-47	1A8T1
5950-617-8695	3-5	1A4A1T2	5950-679-9490	3-42	1A7T7
5950-626-9995	3-12	1A4A221	5950-679-9493	3-40	1A7A1T102
5950-645-5866	3-17	1A4A5T1	5950-679-9494	3-45	1A7A4T201
5950-645-5866	3-34	1A10L2	5950-679-9500	3-51	1A9T2
5950-647-7136	3-34	1A10L1	5950-679-9503	3-34	1A10L3
5950-647-9291		1A4A5L7	5950-679-9504	3-33	1A10T1
5950-647-9291	3-6	1A4A3L1	5950-679-9508	3-35	1A12L1
5950-647-9291	3-6	1A4A3L6	5950-679-9511	3-35	1A12T1
5950-651-5323	3-9	1A4A3A7T2	5950-679-9539	3-57	1A2A1T1
5950-655-0253	3-51	1A9L1	5950-683-3139	3-40	1A7A1T101
5950-655-0844	3-17	1A4A5L5	5950-683-3437	3-19	1A5A1L1
5950-676-7095	3-27	1A5A2L1	5950-683-3437	3-19	1A5A1L2
5950-678-4048		1A2A2L2	5950-683-3437	3-27	1A5A2L5
5950-678-5331	3-54	1A6A1L1	5950-683-3437	3-28	1A5A2L6
5950-679-9333	3-37	1A3L10	5950-683-3454	3-28	1A5A2L2
5950-679-9334	3-37	1A3L11	5950-683-3461	3-12	1A4A2L1
5950-679-9341	3-37	1A3T1	5950-683-3461	3-12	1A4A2L3
5950-679-9345	3-2	1A4L1	5950-683-3461	3-27	1A5A2L3
5950-679-9345	3-2	1A4L17	5950-683-7977	3-12	1A4A2T1
5950-679-9450	3-17	1A4A5L1	5950-686-6425	3-14	1A4A4L21
5950-679-9451	3-17	1A4A5L4	5950-686-6425	3-14	1A4A4L22
5950-679-9461	3-20	1A5A7T1	5950-686-6425	3-14	1A4A4L23



SECTION IV INDEX-FEDERAL STOCK NUMBER AND REFERENCE NUMBER CROSS REFERENCE  
TO FIGURE AND ITEM NUMBER OR REFERENCE DESIGNATION (CONTINUED)

FEDERAL STOCK NUMBER	FIGURE NUMBER	ITEM NUMBER OR REF. DESIGNATION	FEDERAL STOCK NUMBER	FIGURE NUMBER	ITEM NUMBER OR REF. DESIGNATION
5950-686-6425	3-14	1A4A4L24	5950-990-0092	3-38	1A3L1
5950-686-6425	3-14	1A4A4I25	5950-991-3367		1A4A3L7
5950-686-6425	3-14	1A4A4I34	5950-991-3367	3-2	1A4L4
5950-686-6759	3-23	1A5A5L2	5950-991-3367	3-2	1A4L6
5950-686-6759	3-25	1A5A4L2	5950-991-3367	3-2	1A4L7
5950-701-5926		1A4A4L36	5950-991-3367	3-2	1A4I9
5950-754-6944	3-53	1A6L1	5950-991-3367	3-2	1A4L10
5950-754-6944	3-53	1A6L2	5955-678-1958	3-12	1A4A2Y2
5950-758-4278		1A4A4T2	5955-679-9449	3-17	1A4A5HR1
5950-796-3120	3-2	1A4L3	5955-685-8698	3-12	1A4A2Y1
5950-796-3120	3-2	1A4L5	5955-686-7228	3-12	1A4A2Y3
5950-796-3120	3-2	1A4L8	5955-686-7230	3-12	1A4A2Y4
5950-796-3120	3-2	1A4L11	5956-678-5479	3-53	1A6T1
5950-796-3120	3-38	1A3L3	5960-045-8639	3-6	1A4A3V1
5950-807-3425	3-6	1A4A3I9	5960-045-8639	3-6	1A4A3V3
5950-810-5556		1A4A4T2A	5960-045-8639	3-16	1A4A4V9
5950-820-1367	3-22	1A12L2	5960-088-4211	3-6	1A4A3E19
5950-823-3222	3-2	1A4L12	5960-088-4211	3-6	1A4A3E20
5950-823-3222	3-2	1A4L13	5960-088-4211	3-6	1A4A3E21
5950-826-0179		1A4A4L35	5960-134-6004	3-16	1A4A4V2
5950-826-0179		1A4A4L37	5960-134-6004	3-16	1A4A4V4
5950-833-6629	3-51	1A9T3	5960-134-6004	3-16	1A4A4V5
5950-845-6929		1A2A1L1	5960-134-6004	3-16	1A4A4V7
5950-845-6929		1A2A1L2	5960-134-6004	3-16	1A4A4V8
5950-845-6929	3-38	1A3L5	5960-134-6004	3-16	1A4A4V10
5950-845-6929	3-38	1A3L6	5960-188-6584	3-6	1A4A3V4
5950-845-6929	3-38	1A3L7	5960-230-5226	3-7	1A4A3A3V1
5950-850-8716	3-15	1A4A4E28	5960-230-5226	3-7	1A4A3A3V2
5950-878-2442	3-37	1A3L12	5960-230-5226	3-8	1A4A3A6V1
5950-986-3369	3-37	1A3L4	5960-230-5226	3-12	1A4A4V1
5950-986-3369	3-57	1A2A2L1	5960-230-5226	3-12	1A4A2V2

SECTION IV INDEX-FEDERAL STOCK NUMBER AND REFERENCE NUMBER CROSS REFERENCE  
TO FIGURE AND ITEM NUMBER OR REFERENCE DESIGNATION (CONTINUED)

FEDERAL STOCK NUMBER	FIGURE NUMBER	ITEM NUMBER OR REF. DESIGNATION	FEDERAL STOCK NUMBER	FIGURE NUMBER	ITEM NUMBER OR REF. DESIGNATION
5960-230-5226	3-12	1A4A2V3	5960-564-4772	3-16	1A4A4E5
5960-230-5226	3-12	1A4A2V4	5960-564-4772	3-16	1A4A4E7
5960-230-5226	3-24	1A5A5V3	5960-564-4772	3-16	1A4A4E8
5960-230-5226	3-26	1A5A4V3	5960-564-4772	3-16	1A4A4E10
5460-230-5241	3-27	1A5A2V1	5960-615-0243	3-16	1A4A4V6
5960-230-5241	3-28	1A5A2V3	5960-615-0243	3-37	1A3V1
5960-256-9989		1A5A4V1	5960-615-0243	3-37	1A3V2
5960-256-9989	3-19	1A5A1V1	5960-617-5790		1A8E9
5960-256-9989	3-23	1A5A5V1	5960-636-2218	3-53	1A6V2
5960-256-9989	3-24	1A5A5V2	5960-686-7353	3-6	1A4A3E16
5960-256-9989	3-24	1A5A5V4	5960-686-7500		1A3E1
5960-256-9989	3-26	1A5A4V2	5960-686-7500		1A3E2
5960-256-9989	3-26	1A5A4V4	5960-686-7500	3-16	1A4A4E6
5960-256-9989	3-31	1A5A6V1	5960-775-3080	3-37	1A3E5
5960-256-9989	3-32	1A5A6V2	5960-775-3080	3-37	1A3E6
5960-256-9989	3-32	1A5A6V3	5960-792-7432	3-47	1A8V1
5960-256-9989	3-32	1A5A6V4	5960-846-6619	3-53	1A6V1
5960-261-8679	3-11	1A4A3A8V1	5960-858-5172	3-6	1A4A3E15
5960-261-8679	3-27	1A5A2V2	5960-858-5172	3-6	1A4A3E18
5960-262-0210	3-16	1A4A4V1	5960-858-5172	3-16	1A4A4E9
5960-262-0210	3-16	1A4A4V3	5960-860-7710		1A5A7E1
5960-262-0210	3-21	1A5A7V1	5960-860-7710	3-16	1A4A4E1
5960-262-3002	3-6	1A4A3V2	5960-860-7710	3-16	1A4A4E3
5960-264-1028		1A5A4E1	5960-860-7710	3-2	1A6E1
5960-264-1028		1A5A5E1	5960-860-7710	3-52	1A6E2
5960-264-1028	3-31	1A5A6E1	5960-985-9019	3-38	1A3V3
5960-556-1332	3-47	1A8V2	5960-985-9019	3-38	1A3V4
5960-564-4772		1A8E6	5961-023-2701	3-8	1A4A3A6Q1
5960-564-4772	3-6	1A4A3E17	5961-023-2701	3-8	1A4A3A6Q2
5960-564-4772	3-16	1A4A4E2	5961-023-2701	3-8	1A4A3A6Q3
5960-564-4772	3-16	1A4A4E4	5961-023-2701	3-9	1A4A3A7Q1

SECTION IV INDEX-FEDERAL STOCK NUMBER AND REFERENCE NUMBER CROSS REFERENCE  
TO FIGURE AND ITEM NUMBER OR REFERENCE DESIGNATION (CONTINUED)

FEDERAL STOCK NUMBER	FIGURE NUMBER	ITEM NUMBER OR REF. DESIGNATION	FEDERAL STOCK NUMBER	FIGURE NUMBER	ITEM NUMBER OR REF. DESIGNATION
5961-023-2701	3-9	1A4A3A7Q2	5961-552-9852	3-6	1A4A3CR6
5961-023-2701	3-9	1A4A3A7Q3	5961-553-6320	3-53	1A6CR1
5961-023-2701	3-10	1A4A3A2Q3	5961-553-7012	3-24	1A5A5Q2
5961-023-2701	3-10	1A4A3A2Q4	5961-553-7012	3-24	1A5A5Q3
5961-023-2701	3-10	1A4A3A2Q5	5961-553-7012	3-26	1A5A4Q2
5961-023-2701	3-10	1A4A3A2Q6	5961-553-7012	3-26	1A5A4Q3
5961-023-2701	3-17	1A4A5Q13	5961-553-7012	3-32	1A5A6Q2
5961-060-7587	3-11	1A4A3A8CR1	5961-553-7012	3-32	1A5A6Q3
5961-060-7587	3-11	1A4A3A8CR2	5961-556-2091		1A4A3A7CR2
5961-284-6516	3-5	1A4A1CR1	5961-556-2091	3-10	1A4A3A2CR1
5961-284-6516	3-6	1A4A3CR7	5961-556-2091	3-10	1A4A3A2CR2
5961-284-6516	3-8	1A4A3A6CR1	5961-556-2091	3-10	1A4A3A2CR5
5961-284-6516	3-8	1A4A3A6CR2	5961-556-2091	3-10	1A4A3A2CR6
5961-284-6516	3-8	1A4A3A6CR3	5961-581-9888	3-17	1A4A5Q1
5961-284-6516	3-37	1A3CR4	5961-581-9888	3-17	1A4A5Q2
5961-284-6516	3-53	1A6CR2	5961-581-9888	3-17	1A4A5Q4
5961-284-6516	3-53	1A6CR3	5961-615-0590	3-29	1A5A3A1CR1
5961-284-6516	3-53	1A6CR5	5961-615-0590	3-30	1A5A3A2CR1
5961-284-6516	3-53	1A6CR6	5961-679-9435	3-14	1A4A4CR1
5961-284-6516	3-54	1A6A1CR1	5961-688-6316	3-34	1A1OCR1
5961-542-7005	3-40	1A7A1Q102	5961-688-6316	3-34	1A1OCR5
5961-542-7005	3-45	1A7A4Q201	5961-688-6316	3-34	1A1OCR8
5961-542-7005	3-45	1A7A4Q202	5961-688-6316	3-35	1A12CR1
5961-543-0490	3-37	1A3CR2	5961-688-6316	3-35	1A12CR2
5961-543-0490	3-37	1A3CR3	5961-688-6316	3-35	1A12CR3
5961-543-0490	3-37	1A3CR5	5961-688-6316	3-35	1A12CR4
5961-552-9852	3-6	1A4A3CR1	5961-688-6316	3-35	1A12CR5
5961-552-9852	3-6	1A4A3CR2	5961-688-6316	3-35	1A12CR6
5961-552-9852	3-6	1A4A3CR3	5961-688-6316	3-35	1A12CR7
5961-552-9852	3-6	1A4A3CR4	5961-688-6316	3-35	1A12CR8
5961-552-9852	3-6	1A4A3CR5	5961-688-6316	3-35	1A12CR9

SECTION IV INDEX-FEDERAL STOCK NUMBER AND REFERENCE NUMBER CROSS REFERENCE  
TO FIGURE AND ITEM NUMBER OR REFERENCE DESIGNATION (CONTINUED)

FEDERAL STOCK NUMBER	FIGURE NUMBER	ITEM NUMBER OR REF. DESIGNATION	FEDERAL STOCK NUMBER	FIGURE NUMBER	ITEM NUMBER OR REF. DESIGNATION
5961-688-6316	3-35	1A12CR10	5961-688-6316	3-35	1A12CR41
5961-688-6316	3-35	1A12CR11	5961-688-6316	3-35	1A12CR42
5961-688-6316	3-35	1A12CR12	5961-688-6316	3-35	1A12CR43
5961-688-6316	3-35	1A12CR13	5961-688-6316	3-35	1A12CR44
5961-688-6316	3-35	1A12CR14	5961-688-6316	3-37	1A3CR1
5961-688-6316	3-35	1A12CR15	5961-688-6316	3-51	1A9CR1
5961-688-6316	3-35	1A12CR16	5961-688-6316	3-51	1A9CR2
5961-688-6316	3-35	1A12CR17	5961-688-6316	3-51	1A9CR3
5961-688-6316	3-35	1A12CR18	5961-688-6316	3-51	1A9CR4
5961-688-6316	3-35	1A12CR19	5961-735-1433	3-34	1A10CR6
5961-688-6316	3-35	1A12CR20	5961-735-1433	3-34	1A10CR7
5961-688-6316	3-35	1A12CR21	5961-779-3241	3-17	1A4A5CR3
5961-688-6316	3-35	1A12CR22	5961-800-1084	3-40	1A7A1Q101
5961-688-6316	3-35	1A12CR23	5961-818-4487	3-12	1A4A2Q1
5961-688-6316	3-35	1A12CR24	5961-818-4487	3-12	1A4A2Q2
5961-688-6316	3-35	1A12CR25	5961-818-4487	3-24	1A5A5Q1
5961-688-6316	3-35	1A12CR26	5961-818-4487	3-26	1A5A4Q1
5961-688-6316	3-35	1A12CR27	5961-818-4487	3-32	1A5A6Q1
5961-688-6316	3-35	1A12CR28	5961-833-2249	3-17	1A4A5Q5
5961-688-6316	3-35	1A12CR29	5961-833-2249	3-17	1A4A5Q6
5961-688-6316	3-35	1A12CR30	5961-833-2249	3-17	1A4A5Q7
5961-688-6316	3-35	1A12CR31	5961-833-2249	3-17	1A4A5Q8
5961-688-6316	3-35	1A12CR32	5961-833-2249	3-17	1A4A5Q9
5961-688-6316	3-35	1A12CR33	5961-833-2249	3-17	1A4A5Q10
5961-688-6316	3-35	1A12CR34	5961-833-2249	3-17	1A4A5Q11
5961-688-6316	3-35	1A12CR35	5961-833-2249	3-17	1A4A5Q12
5961-688-6316	3-35	1A12CR36	5961-837-1924		1A4A5CR2
5961-688-6316	3-35	1A12CR37	5961-837-1924	3-17	1A4A5CR1
5961-688-6316	3-35	1A12CR38	5961-840-5466	3-20	1A5A7CR2
5961-688-6316	3-35	1A12CR39	5961-840-5466	3-20	1A5A7CR3
5961-688-6316	3-35	1A12CR40	5961-866-0476		1A4A4CR2
			5961-866-0476		1A4A4CR3

SECTION IV INDEX-FEDERAL STOCK NUMBER AND REFERENCE NUMBER CROSS REFERENCE  
 TO FIGURE AND ITEM NUMBER OR REFERENCE DESIGNATION (CONTINUED)

FEDERAL STOCK NUMBER	FIGURE NUMBER	ITEM NUMBER OR REF. DESIGNATION	FEDERAL STOCK NUMBER	FIGURE NUMBER	ITEM NUMBER OR REF. DESIGNATION
5961-866-0476	3-5	1A4A1CR3	5961-892-0620	3-34	1A1OCR9
5961-866-0476	3-5	1A4A1CR4	5961-912-4907		1A2A1CR1
5961-866-0476	3-5	1A4A1CR5	5961-912-4907		1A2A1CR2
5961-866-0476	3-5	1A4A1CR6			
5961-866-0476	3-5	1A4A1CR7	5961-978-7660	3-53	1A6CR4
5961-866-0476	3-5	1A4A1CR8	5961-989-6706	3-54	1A6A1Q1
5961-866-0476	3-9	1A4A3A7CR1	5965-624-4134	3-55	1A13A3M1
5961-866-0476	3-10	1A4A3A2CR3	5965-678-5305	3-55	1A13A3HT1
5961-866-0476	3-10	1A4A3A2CR4	5965-822-8549	3-57	1A2IS1
5961-866-0476	3-20	1A5A7CR1	5985-679-9529	3-22	1A2K1
5961-866-0476	3-20	1A5A7CR4	5985-990-9603		1A2A2
5961-866-0476	3-20	1A5A7CR5	5995-823-3068		1A13A2W4
5961-866-0476	3-20	1A5A7CR6	5995-889-0673		1A13A2W2
5961-866-0476	3-20	1A5A7CR7	5995-889-0673		1A13A2W5
5961-866-0476	3-24	1A5A5CR1	5995-889-0673		1A13A2W6
5961-866-0476	3-24	1A5A5CR2	5995-889-0673		1A13A2W7
5961-866-0476	3-25	1A5A4CR1	5995-889-0673		1A13A2W8
5961-866-0476	3-26	1A5A4CR2	5995-935-0340		1A13A2W1
5961-866-0476	3-28	1A5A2CR1	5995-935-0342		1A13A2W9
5961-866-0476	3-31	1A5A6CR2	5999-734-1349	3-11	1A4A3A6TB1
5961-866-0476	3-32	1A5A6CR1	5999-790-0584	3-14	1A4A4TB1
5961-866-0476	3-32	1A5A6CR3	5999-790-0585	3-8	1A4A3A6TB1
5961-866-0476	3-37	1A3CR6	5999-790-0586	3-27	1A5A2TB2
5961-882-5988	3-5	1A4A1Q1	5999-790-0587	3-28	1A5A2TB1
5961-882-5988	3-5	1A4A1Q2	5999-790-0589		1A5A3A1TB1
5961-882-5988	3-5	1A4A1Q3	5999-790-0590	3-9	1A4A3A7TB1
5961-882-5988	3-5	1A4A1Q4	5999-790-0594	3-19	1A5A1TB1
5961-882-5988	3-5	1A4A1Q5	5999-790-0598	3-5	1A4A1TB2
5961-882-5988	3-5	1A4A1Q6	5999-790-0641	3-5	1A4A1TB1
5961-882-5988	3-5	1A4A1Q7	5999-790-4082	3-17	1A4A5E15
5961-883-5305	3-17	1A4A5Q3	5999-793-0192	3-41	1A7A1TB101

SECTION IV INDEX-FEDERAL STOCK NUMBER AND REFERENCE NUMBER CROSS REFERENCE  
TO FIGURE AND ITEM NUMBER OR REFERENCE DESIGNATION (CONTINUED)

FEDERAL STOCK NUMBER	FIGURE NUMBER	ITEM NUMBER OR REF. DESIGNATION	FEDERAL STOCK NUMBER	FIGURE NUMBER	ITEM NUMBER OR REF. DESIGNATION
5999-793-0194	3-12	1A4A2TB1	6240-155-8714	3-52	1A6DS1
5999-795-7293	3-12	<del>1A4A2TB2</del>	6240-179-1811	3-49	1A1DS2
6105-679-9396	3-14	1A4A4B1	6240-223-9100	<del>3-36</del>	1A3DS1
6210-023-8555	3-36	1A3XDS1	6625-649-3228	3-47	1A8M1
6210-023-8555	3-49	1A1XDS1	6625-678-5478	3-52	<del>1A6M1</del>
6210-023-8555	3-52	1A6XDS1	6625-679-9458	3-21	1A5A7M1
6210-023-8555	3-52	1A6XDS2	6625-679-9555	3-3	<del>1A4M1</del>
6210-061-2633		1A12DS2	6625-729-6906	3-57	<del>1A2M1</del>
6210-067-8377	3-35	1A12XDS1	6625-812-9785	3-36	<del>1A3M1</del>
<del>6210-067-8381</del>	3-33	1A10X11			
6210-299-3025		1A3DS4	<u>REFERENCE NO.</u>	<u>MFG. CODE</u>	<u>FIG. NO.</u>
<del>6210-583-9434</del>	3-33	1A10DS1	A013354	82877	3-46
6210-583-9437		1A6DS3	A10250	<del>70674</del>	
6210-688-5543		<del>1A1E1</del>	A10250	<del>70674</del>	3-42
6210-761-6371		1A6DS4	<del>A10760</del>	<del>70674</del>	3-20
6210-813-2725	3-3	1A4XDS1	<del>A10760</del>	70674	3-20
6210-813-2725	3-3	1A4XDS2	A10760	<del>70674</del>	3-20
6210-813-2725		1A4XDS3	<del>A10760</del>	<del>70674</del>	3-42
6210-813-2725		<del>1A4XDS4</del>	<del>A10760</del>	<del>70674</del>	3-42
6210-814-3204	3-3	1A4E1	<del>A10760</del>	<del>70674</del>	3-42
6210-814-3204	3-3	<del>1A4E2</del>	<del>A10796</del>	<del>70674</del>	3-53
6210-814-3204		1A4E3	<del>A14475</del>	<del>70674</del>	3-51
6210-814-3204		<del>1A4E4</del>	<del>A8344</del>	<del>70674</del>	3-51
6240-143-3060	3-35	1A12DS1	<del>A8482</del>	<del>70674</del>	3-34
6240-155-7836	3-3	1A4DS1	A9771	<del>70674</del>	3-42
6240-155-7836	3-3	1A4DS2	A9848-1	72914	3-3
6240-155-7836		1A4DS3	A9848-1	72914	3-3
6240-155-7836		1A4DS4	A9848-1	72914	
6240-155-8706	3-33	1A10I1	A9848-1	72914	1A4E4
6240-155-8706	3-52	1A6DS2	A9849-1	<del>72914</del>	3-3
6240-155-8714	3-49	1A1DS1	A9849-1	72914	3-3
					1A4XDS1
					1A4XDS2

SECTION IV INDEX-FEDERAL STOCK NUMBER AND REFERENCE NUMBER CROSS REFERENCE  
TO FIGURE AND ITEM NUMBER OR REFERENCE DESIGNATION (CONTINUED)

FEDERAL STOCK NUMBER	FIGURE NUMBER	ITEM NUMBER OR REF. DESIGNATION	FEDERAL STOCK NUMBER	FIGURE NUMBER	ITEM NUMBER OR REF. DESIGNATION
<u>REFERENCE NO.</u>	MFG. CODE	FIG. NO. <u>REFERENCE DESIGNATION</u>	<u>REFERENCE NO.</u>	MFG. CODE	FIG. NO. <u>REFERENCE DESIGNATION</u>
A9849-1	72914	1A4XDS3	CK15AX223M	81349	1A5A5C30
A98494	72914	<del>1A4XDS4</del>	CK15AX223M	81349	1A5A6C28
BB61-102TW6X	71590	3-15 1A4A4C61	CK15AX223M	81349	1A5A6C30
BB61-102TW6X	71590	3-15 1A4A4C109	CK16AX473M	81349	3-27 1A5A2C18
BC3433	97315	3-40 1A7A1T101	CK60AW102M	81349	3-10 1A4A3A2C29
BS217	99800	3-14 1A4A4L21	CK60AW102M	81349	3-10 1A4A3A2C30
BS217	99800	3-14 1A4A4L22	CK60AW102M	81349	3-38 1A3C2
BS217	99800	3-14 1A4A4L23	CK60AW102M	81349	3-38 1A3C3
BS217	99800	3-14 1A4A4L24	CK60AW102M	81349	3-38 1A3C6
BS217	99800	3-14 1A4A4L25	CK61AW222M	81349	1A12C5
BS217	99800	3-14 1A4A4L34	CK61AW222M	81349	1A12C6
B2103	19500	3-38 1A3K1	CK61AW222M	81349	1A12C7
CBUH605i	80694	3-51 1A9T2	CK61AW222M	81349	1A12C8
CB11RE511J	81349	1A2A1C3	CK61AW222M	81349	1A12C9
CB11BE511J	81349	1A2A1C4	CK61AW222M	81349	1A12C10
CC22RH100D	81349	1A4A4C58	CK61AW222M	81349	1A12C11
CC22RH240G	81349	1A4A4C140	CK61AW222M	81349	1A12C12
CC22SH050D	81349	1A4A4C42	CK61AW222M	81349	1A12C13
CC22SH200J	81349	1A4JA4C130	CK61AW222M	81349	1A12c14
CC30LH430F	81349	1A2A1C5	CK61AW222M	81349	1A12C15
CC30LH430F	81349	1A2A1C6	CK61AW222M	81349	1A12C16
CC33PG820F	81349	3-17 1A4A5C3	CK61AW222M	81349	1A12C17
CE13C240K	81349	3-37 1A3C53	CK61AW222M	81349	1A12C18
CK06CW103K	81349	3-6 1A4A3C44	CK61AW222M	81349	1A12C19
CK06CW103K	81349	3-7 1A4A3A3C1	CK61AW222M	81349	1A12C20
CK06CW103K	81349	3-7 1A4A3AC3	CK61AW222M	81349	1A12C21
CK06CW103K	81349	3-7 1A4A3A3C6	CK61AW222M	81349	1A12C22
CK06CW103K	81349	3-7 1A4A3A3C7	CK61AW222M	81349	1A12C23
CK13AX332M	81349	3-17 1A4A5C23	CK61AW222M	81349	1A12C24
CK13AX332M	81349	3-17 1A4A5C27	CK61AW222M	81349	1A12C26
CK15AX223M	81349	1A5A4C30	CK61AW222M	81349	1A12C26

SECTION IV INDEX-FEDERAL STOCK NUMBER AND REFERENCE NUMBER CROSS REFERENCE  
TO FIGURE AND ITEM NUMBER OR REFERENCE DESIGNATION (CONTINUED)

FEDERAL STOCK NUMBER	FIGURE NUMBER	ITEM NUMBER OR REF. DESIGNATION	FEDERAL STOCK NUMBER	FIGURE NUMBER	ITEM NUMBER OR REF. DESIGNATION
<u>REFERENCE NO.</u>	MFG. CODE	FIG. NO. REFERENCE DESIGNATION	<u>REFERENCE NO.</u>	MFG. CODE	FIG. No. REFERENCE DESIGNATION
CK61AW222M	81349	1A12C27	CK70AW102M	81349	1A2A2C8
CK61AW222M	81349	1A12C28	CK70AW102M	81349	1A2A2C9
CK61AW222M	81349	1A12C29	CK70AW102M	81349	1A2A2C10
CK61AW222M	81349	1A12C30	CL21CK020TP3	81349	3-28 1A5A2C10
CK61AW222M	81349	1A12C31	CL23CR100TN3	81349	3-5 1A47A1C16
CK61AW222M	81349	1A12C32	CL24BJ4R5TP3	81349	3-19 1A5A1C6
CK61AW222M	81349	1A12C33	CL24BQ010SP3	81349	3-12 1A4A2C5
CK61AW222M	81349	1A12C34	CL25BJ180TP3	81349	3-8 1A4A3A6C11
CK61AW222M	81349	1A12C35	CL25BJ180TP3	81349	3-24 1A5A5C20
CK61AW222M	81349	1A12C36	CL25BJ180TP3	81349	3-26 1A5A4C20
CK61AW222M	81349	1A12C37	CL25BJ180TP3	81349	3-32 1A5A6C20
CK61AW222M	81349	1A12C38	CL25BQ04SP3	81349	3-23 1A5A5C16
CK61AW222M	81349	1A12C39	CL25BQ04SP3	81349	3-25 1A5A4C16
CK61AW222M	81349	1A12C40	CL27BG200UN3	81349	3-17 1A4A5C18
CK61AW222M	81349	1A12C41	CL27BG200UN3	81349	3-17 1A4A5C19
CK61AW222M	81349	1A12C42	CL34BQOR5MP3	81349	3-19 1A5A1C4
CK61AW222M	81349	1A12C43	CM05E560G03	81349	3-54 1A6A1C8
CK61AW222M	81349	1A12C44	CM05E750G03	81349	3-31 1A5A6C6
CK61AW222M	81349	1A12C45	CM05E820G03	81349	3-23 1A5A5C8
CK61AW222M	81349	1A12C46	CM05E820G03	81349	3-25 1A5AC8
CK61AW222M	81349	1A12C47	CM05E820G03	81349	3-31 1A5A6C6
CK61AW222M	81349	1A12C48	CM05F121G03	81349	3-23 1A5A5C8
CK62AW472M	81349	3-53 1A6C17	CM05F12103	81349	3-25 1A5A4C8
CK62AW472M	81346	3-54 1A6A1C5	CM5F910G03	81349	3-23 1A5A5C8
CK63AW103M	81349	1A8C2	CM05F910G03	81349	?-25 1A5A4C8
CK63AW103M	81349	3-37 1A3C51	CM05F910G03	81349	3-31 1A5A6C6
CK63AW103M	81349	3-38 1A3C1	CM06FD472G03	81349	3-17 1A4A5C20
CK63AW103M	81349	3-38 1A3C36	CM06F202G03	81349	3-53 1A6C20
CK63AW103M	81349	3-38 1A3C37	CM06F471G03	81349	3-53 1A6C19
CK63AW103M	81349	3-48 1A8C1	CM06F471G03	81349	3-53 1A6C22
CK70AW102M	81349	1A2A2C7	CM06F681G03	81349	3-53 1A6C21



SECTION IV INDEX-FEDERAL STOCK NUMBER CROSS REFERENCE  
TO FIGURE AND ITEM NUMBER AND REFERENCE DESIGNATION (CONTINUED)

FEDERAL STOCK NUMBER	FIGURE NUMBER		ITEM NUMBER OR REF. DESIGNATION	FEDERAL STOCK NUMBER	FIGURE NUMBER		ITEM NUMBER OR REF. DESIGNATION
	MFG. CODE	FIG. NO.	REFERENCE DESIGNATION		REFERENCE NO.	MFG. CODE	FIG. NO.
CM07F203J03	81349	3-2	1A4C45	CZ24BKB224	81349	3-2	1A4C29
CM07F682G03	81349		1A6C8	CZ24BKB224	81349	3-2	1A4C30
CM07F682G03	81349	3-53	1A6C5	CZ24BKB224	81349	3-2	1A4C33
CM07F682G03	81349	3-53	1A6C9	CZ24BKB224	81349	3-2	1A4C37
CM15E511G	72136	3-38	1A3C18	CZ24BKB224	81349	3-2	1A4C40
CM20E202G-500WV	72136	3-5	1A4A1C3	CZ24BKB224	81349	3-6	1A4A3C19
CM20E242G	72136	3-5	1A4A1C2	CZ24BKF103	81349	3-38	1A3C41
CM35E752G0	72136	3-5	1A4A1C5	CZ24BKF103	81349	3-38	1A3C43
CM35F133G03-100v	72136	3-5	1A4A1C4	CZ24BKF103	81349	3-38	1A3C44
CM35F203G03-100V	72136	3-5	1A4A1C8	CZ24BKF103	81349	3-38	1A3C48
CM35F203G03-100V	72136	3-5	1A4A1C9	C3100E3R	81640	3-49	1A1S1
CM35F203G03-100V	72136	3-5	1A4A1C10	C64969-1G	82090	3-57	1A2A203
CM35F203G03-100V	72136	3-5	1A4A1C11	C64969-1G	82090	3-57	1A2A204
CR1070C130F3	01526	3-37	1A3S8	DA15S	71468	3-2	1A4J2
CSR7W4000-5	00213		1A4A4R67	DAF15s	71468	3-20	1A5A7J1
CU987GCR110A	80058		1A2A1	DAF15S	71468	3-20	1A5A7J2
CY16C102J	81349	3-17	1A4A5C1	DAF15S	71468	3-20	1A5A7J14
CY16C102J	81349	3-17	1A4A5C4	DA049-123B	71590		1A4A4C183
CY16C102J	81349	3-17	1A4A5C7	DA049-123B	71590	3-6	1A4A3C5
CY16C102J	81349	3-17	1A4A5C10	DA049-123B	71590	3-6	1A4A3C9
CY16C102J	81349	3-17	1A4A5C13	DA049-123B	71590	3-6	1A4A3C10
CY16C102J	81349	3-17	1A4A5C14	DA049-123B	71590	3-6	1A4A3C13
CY16C102J	81349	3-17	1A4A5C16	DA049-123B	71590	3-6	1A4A3C16
CY16C102J	81349	3-17	1A4A5C32	DA049-123B	71590	3-6	1A4A3C17
CY16C102J	81349	3-17	1A4A5C36	DA049-123B	71590	3-6	1A4A3C18
CY16C68J	81349	3-17	1A4A5C5	DA049-123B	71590	3-15	1A4A4C1
CY16C681J	81349	3-17	1A4A5C29	DA049-123B	71590	3-15	1A4A4C4
CY16C681J	81349	3-17	1A4A5C34	DA049-123B	71590	3-15	1A4A4C17
CY16C681J	81349	3-17	1A4A5C38	DA049-123B	71590	3-15	1A4A4C23
CZ24BKB224	81349	3-2	1A4C21	DA049-123B	71590	3-15	1A4A4C44
CZ24BKB224	81349	3-2	1A4C22	DA049-123B	71590	3-15	1A4A4C45
				DA049-123B	71590	3-15	1A4A4C47

SECTION IV INDEX FEDERAL STOCK NUMBER AND REFERENCE NUMBER CROSS REFERENCE  
TO FIGURE AND ITEM NUMBER OR REFERENCE DESIGNATION (CONTINUED)

FEDERAL STOCK NUMBER	FIGURE NUMBER		ITEM NUMBER OR REF. DESIGNATION	FEDERAL STOCK NUMBER	FIGURE NUMBER		ITEM NUMBER OR REF. DESIGNATION
	MPG. CODE	FIG. NO.	REFERENCE DESIGNATION		MPG. CODE	FIG. NO.	REFERENCE DESIGNATION
REFERENCE NO.				REFERENCE NO.			
DA049-123B	71590	3-15	1A4A4C63	DA933-013	71590	3-54	1A6A1C10
DA049-123B	71590	3-15	1A4A4C92	DA933-027	71590	3-54	1A6A1C10
DA049-123B	71590	3-15	1A4A4C95	DA934-008	71590	3-6	1A4A3C29
DA049-123B	71590	3-15	1A4A4C99	DA934-008	71590	3-6	1A4A3C35
DA049-123B	71590	3-15	1A4A4C100	DCF37S	71468	3-2	1A4J1
DA049-123B	71590	3-15	1A4A4C102	DCF37S	71468	3-2	1A4J7
DA049-123B	71590	3-15	1A4A4C104	DC37T	71468	3-6	1A4A3P1
DA049-123B	71590	3-15	1A4A4C108	DC37P10	71785	3-14	1A4A4P2
DA049-123B	71590	3-15	1A4A4C111	DM0073	99800	3-17	1A4A5L2
DA049-123B	71590	3-15	1A4A4C112	DM0073	99800	3-17	1A4A5L3
DA049-123B	71590	3-15	1A4A4C116	DM10C150J	72136	3-37	1A3C71
DA049-123B	71590	3-15	1A4A4C122	DM15E101F0300 WV4CR	72136	3-23	1A5A5C8
DA049-123B	71590	3-15	1A4A4C132	DM5E101F0300 WV4CR	72136	3-25	1A5A4C8
DA049-123B	71590	3-15	1A4A4C134	DM5E101F0300 WV4CR	72136	3-31	1A5A6C6
DA049-123B	71590	3-15	1A4A4C135	DM15E1050F0500 WV4CR	72136	3-23	1A5A5C8
DA049-123B	71590	3-15	1A4A4C142	DM5E105F0500 WV4CR	72136	3-25	1A5A4C8
DA049-123B	71590	3-15	1A4A4C174	DM5E1050F0500 WV4CR	72136	3-29	1A5A3A1C5
DA049-123B	71590	3-15	1A4A4C179	DM15E1050F0500 WV4CR	72136	3-30	1A5A3A2C5
DA15P	71468	3-14	1A4A4P1	DM5E1050F0500 WV4CR	72136	3-31	1A5A6C6
DA15P	71468	3-23	1A5A5P1	DM5E1070F0300 WV4CR	72136	3-23	1A5A5C8
DA15P	71468	3-25	1A5A4P1	DM15E1070F0300 WV4CR	72136	3-25	1A5A4C8
DA15P	71468	3-31	1A5A6P1	DM15E1070F0300 WV4CR	72136	3-29	1A5A3A1C5
DA855-007	71590	3-37	1A3C70	DM15E107F0300 WV4CR	72136	3-30	1A5A3H2C5
DA858-003	71590	3-37	1A3C20	DM15E1070F0300 WV4CR	72136	3-31	1A5A6C6
DA931-001	71590	3-54	1A6A1C10	DM15E1070F0300 WV4CR	72136	3-29	1A5A3A1C5
DA931-003	71590	3-54	1A6A1C10	DM15E107F0300 WV4CR	72136	3-30	1A5A3H2C5
DA931-004	71590	3-54	1A6A1C10	DM15E1070F0300 WV4CR	72136	3-31	1A5A6C6
DA932-001	71590	3-54	1A6A1C10				
DA933-010	71590	3-54	1A6A1C10				
DA933-011	71590	3-54	1A6A1C10				
DA933-012	71590	3-54	1A6A1C10				

SECTION IV INDEX-FEDERAL STOCK NUMBER AND REFERENCE NUMBER CROSS REFERENCE  
TO FIGURE AND ITEM NUMBER OR REFERENCE DESIGNATION (CONTINUED)

FEDERAL STOCK NUMBER	FIGURE NUMBER	ITEM NUMBER OR REF. DESIGNATION		FEDERAL STOCK NUMBER	FIGURE NUMBER	ITEM NUMBER OR REF. DESIGNATION	
<u>REFERENCE NO.</u>	<u>MFG. CODE</u>	<u>FIG. NO.</u>	<u>REFERENCE DESIGNATION</u>	<u>REFERENCE NO.</u>	<u>MFG. CODE</u>	<u>FIG. NO.</u>	<u>REFERENCE DESIGNATION</u>
DM15E1110F0300 WV4CR	72136	3-23	1A5A5C3	DM15E2520G0500 WV4CR	72136	3-29	1A5A3A1C4
DM15E1110F0300 WV4CR	72136	3-25	1A5A4C8	DM15E2520G0500 WV4CR	72136	3-30	1A5A3A2C3
DM15E111050300 WV4CR	72136	3-31	1A5A6C6	DM15E2520G0500 WV4CR	72136	3-30	1A5A3A2C4
DM15E114CGD500 WV4CR	72136	3-23	1A5A5C8	DM15E261F0500 WV4CR	72136	3-27	1A5A2C3
DM15E114CG0500 WV4CR	72136	3-25	1A5A4C8	DM15E261F0500 WV4CR	72136	3-29	1A5A3A1C3
DM15E114CG0500 WV4CR	72136	3-29	1A5A3A1C5	DM15E261F0500 WV4CR	72136	3-29	1A5A3A1C4
DM15E114CG0500 WV4CR	72136	3-30	1A5A3A2C5	DM15E261F0500 WV4CR	72136	3-30	1A5A3A2C3
DM15E114CG0500 WV4CR	81349	3-31	1A5A6C6	DM15E261F0500 WV4CR	72136	3-30	1A5A3A2C4
DM15E1270F0500 WV4CR	72136	3-29	1A5A3A1C5	DM15E261F0300 WV4CR	72136	3-29	1A5A3A1C3
DM15E1270F0500 WV4CR	72136	3-30	1A5A3A2C5	DM15E2670F0300 WV4CR	72136	3-29	1A5A3A1C4
DM15E1330F0500 WV4CR	72136	3-29	1A5A3A1C5	DM15E2670F0300 WV4CR	72136	3-30	1A5A3A2C3
DM15E1330F0500 WV4CR	72136	3-30	1A5A3A2C5	DM15E2670F0300 WV4CR	72136	3-30	1A5A3A2C4
DM15E191F0500 WV4CR	72136	3-29	1A5A3A1C3	DM15E2671F0300 WV4CR	72136	3-27	1A5A2C3
DM15E191F0500 WV4CR	72136	3-29	1A5A3A1C4	DM15E790G0500 WV4CR	72136	3-31	1A5A6C6
DM15E191F0500 WV4CR	72136	3-30	1A5A3A2C3	DM15E860G0500 WV4CR	72136	3-23	1A5A5C8
DM15E191F0500 WV4CR	72136	3-30	1A5A3A2C4	DM15E860G0500 WV4CR	72136	3-25	1A5A4C8
DM15E2320G0500 WV4CR	72136	3-29	1A5A3A1C3	DM15E860G0500 WV4CR	72136	3-31	1A5A6C6
DM15E2320G0500 WV4CR	72136	3-29	1A5A3A1C4	DM15E890G0500 WV4CR	72136	3-23	1A5A5C8
DM15E2320G0500 WV4CR	72136	3-30	1A5A3A2C3	DM15E890G0500 WV4CR	72136	3-25	1A5A4C8
DM15E2320G0500 WV4CR	72136	3-30	1A5A3A2C4	DM15E890G0500 WV4CR	72136	3-31	1A5A6C6
DM15E2520G0500 WV4CR	72136	3-29	1A5A3A1C3	DM15E960G0500 WV4CR	72136	3-23	1A5A5C8

SECTION IV INDEX-FEDERAL STOCK NUMBER AND REFERENCE NUMBER CROSS REFERENCE  
 TO FIGURE AND ITEM NUMBER OR REFERENCE DESIGNATION (CONTINUED)

FEDERAL STOCK NUMBER	FIGURE NUMBER	ITEM NUMBER OR REF. DESIGNATION	FEDERAL STOCK NUMBER	FIGURE NUMBER	ITEM NUMBER OR REF. DESIGNATION
<u>REFERENCE No.</u>	<u>MFG. CODE</u>	<u>FIG. NO.</u> <u>REFERENCE DESIGNATION</u>	<u>REFERENCE NO.</u>	<u>MFG. CODE</u>	<u>FIG. NO.</u> <u>REFERENCE DESIGNATION</u>
DM15E960F0500 WV4CR	72136	3-25 1A5A4C8	D28454	56289	3-43 1A7C22
DM15E960F0500 WV4CR	72136	3-29 1A5A3A1C5	EB43G5	01121	3-23 1A5A5R25
DM15E960F0500 WV4CR	72136	3-30 1A5A3A2C5	EB43G5	01121	3-25 1A5A4R25
DM15E960F0500 WV4CR	72136	3-31 1A5A6C6	E10265A	80008	3-33 1A10T1
DM15FE590F500WV	72136	3-12 1A4A2C26	E10267	80008	3-37 1A3T1
DM20F202F500WV	72136	3-10 1A4A3A2C5	FA4213	07263	3-29 1A5A3A1CR1
DM20F202F500WV	72136	3-10 1A4A3A2C6	FA4213	07263	3-30 1A5A3A2CR1
DM20F202F500WV	72136	3-10 1A4A3A2C37	FHL12G	81349	3-49 1A1XF1
DM20F222G500WV	72136	3-54 1A6A1C6	FHL12G	81349	3-49 1A1XF2
DM20F222G500WV	72136	3-54 1A6A1C9	FS19299	71450	3-40 1A7A1R109
DM20F392G500WV	72136	3-53 1A6C7	FTSM1	98291	3-17 1A4A5E1
DM20F392G500WV	72136	3-54 1A5A1C7	FTSM1	98291	3-17 1A4A5E3
DM20F681G500WV	72136	1A4A4C50	FTSM1	98291	3-17 1A4A5E4
DM30F103K03	72136	3-17 1A4A5C20	FTSM1	98291	3-17 1A4A5E7
DM30F512K03	72136	3-17 1A4A5C20	FTSM1	98291	3-17 1A4A5E9
DM30F562K03	72136	3-17 1A4A5C20	F02A250V1-2AS	81349	3-36 1A3F1
DM30F622K03	72136	3-17 1A4A5C20	F02A250V1AS	81349	3-36 1A3F1
DM30F682K03	72136	3-17 1A4A5C20	F02A250V1AS	81349	3-44 1A7A4F201
DM30F752K03	72136	3-17 1A4A5C20	F02A250V3AS	81349	3-33 1A10F1
DM30F822K03	72136	3-17 1A4A5C20	F02B125V2AS	81349	1A11F1
DM30F912K03	72136	3-17 1A4A5C20	F02B250V1AS	81349	1A11F1
D25433	56289	3-53 1A6C13	F02B250V3-8AS	81349	3-35 1A12F2
D25433	56289	3-53 1A6C14	F03A250V15AS	81349	3-35 1A12F1
D25433	56289	3-53 1A6C15	F03A250V8AS	81349	3-35 1A12F1
D25433	56289	3-53 1A6C16	F219MILL6085A	70417	3-3 1A4MP42
D25846	56289	3-37 1A3C52	F219MILL6085A	70417	3-3 1A4MP45
D27150	56289	3-34 1A10C3	F346-4MILL6085A	70417	3-3 1A4MP2
D27153	56289	3-34 1A10C5	F346-4MILL6085A	70417	3-3 1A4MP4
D28407	56289	3-34 1A10C4	F346-4MILL6085A	70417	3-3 1A4MP11
			F347-4MILL6085A	70417	3-3 1A4MP3

SECTION IV INDEX-FEDERAL STOCK NUMBER AND REFERENCE NUMBER CROSS REFERENCE  
TO FIGURE AND ITEM NUMBER AND REFERENCE DESIGNATION (CONTINUED)

FEDERAL STOCK NUMBER	FIGURE NUMBER		ITEM NUMBER OR REF. DESIGNATION		FEDERAL STOCK NUMBER	FIGURE NUMBER		ITEM NUMBER OR REF. DESIGNATION	
	MPG. CODE	FIG. NO.	FIG. NO.	REFERENCE DESIGNATION		MPG. CODE	FIG. NO.	FIG. NO.	REFERENCE DESIGNATION
REFERENCE NO.					REFERENCE NO.				
F60C500V1A	81349		3-35	1A12F3	JA21069	71450		3-45	1A7A4R205
F60C500V20A	81349			1A13F1	JA21070	71450		3-20	1A5A7R4
F60C500V20A	81349			1A13F2	JA21071	71450		3-20	1A5A7R3
GA1-OUUFFORM5PCT	78488		3-15	1A4A4C32	JA21072	71450		3-20	1A5A7R2
GA1-OUUFFORM5PCT	78488		3-15	1A4A4C37	JH21376	71450		3-53	1A6R18
GA1-OUUFFORM5PCT	78488		3-15	1A4A4C38	JJJ68227	01121		3-43	1A7R16
GA1-OUUFFORM5PCT	78488		3-15	1A4A4C66	JJJ68227	01121		3-43	1A7R21
GA1-OUUFFORM5PCT	78488		3-15	1A4A4C70	JJ034	81349		3-42	1A7J6
GA2-OUUFFORM5PCT	78488		3-15	1A4A4C139	JN17-255A	56289		3-37	1A3C49
GA2-OUUFFORM5PCT	78488		3-15	1A4A4C144	JS5	91929			1A12MP1
GA2-OUUFFORM5PCT	78488		3-15	1A4A4C145	KB22199	71450		3-47	1A8R2
GA2-OUUFFORM5PCT	78488		3-15	1A4A4C146	KB22200	71450		3-47	1A8R8
GA3-OUUFFORM5PCT	78488		3-15	1A4A4C27	KCM15C180G-500WV	72136		3-8	1A4A3A6C8
GA3-9UUFFORM5PCT	78488		3-15	1A4A4C5	KCM15C180G-500WV	72136		3-8	1A4A3A6C9
GA3-9UUFFORM5PCT	78488		3-15	1A4A4C8	KCM15C180G-500WV	72136		3-8	1A4A3A6C10
GA3-9UUFFORM5PCT	78488		3-15	1A4A4C15	KCM15E181F-500WV	72136			1A4A3A3C15
GA3-9UUFFORM5PCT	78488		3-15	1A4A4C21	KCM15E181F-500WV	72136			1A4A3A3C16
GA5-1UUFFORM5PCT	78488			1A4A4C184	KCM15E181F-500WV	72136			1A4A3A3C18
GS3905	93929		3-49	1A1K2	KCM15E181F-500WV	72136			1A4A3A6C15
G5687	12615			1A4A4C65	KCM15E181F-500WV	72136			1A4A3A6C16
HD2123	73293		3-14	1A4A4CR1	KCM15E181F-500WV	72136			1A4A3A6C18
HKLJRWZZ	71400		3-33	1A10XF1	KCM15E240G500WV	72136			1A4A3A3C8
NKLJRWZZ	71400		3-35	1A12XF1	KCM15E240G500WV	72136			1A4A3A3C9
HKLJRWZZ	71400		3-46	1A11XF1	KCM15E240G500WV	72136			1A4A3A3C10
HL1131-5PCT	91637		3-34	1A10R9	KKM12S	81312		3-20	1A5A7J5
HL1131-5PCT	91637		3-34	1A10R10	KS22938	71450		3-42	1A7R1
HP8N	09922			1A13AZH1	KS22938	71450		3-42	1A7R2
R169U	80058		3-1	1A13A3	KS22938	71450		3-42	1A7R10
JA21067	71450		3-21	1A5A7R15	K022661	71450		3-37	1A3R19
JA21068	71450		3-21	1A5A7R16	K6S	81312		3-42	1A7J1
JA21068	71450		3-52	1A6R19	K6S	81312		3-42	1A7J2

SECTION IV INDEX-FEDERAL STOCK NUMBER AND REFERENCE NUMBER CROSS REFERENCE  
TO FIGURE AND ITEM NUMBER OR REFERENCE DESIGNATION (CONTINUED)

FEDERAL STOCK NUMBER	FIGURE			FEDERAL STOCK NUMBER	FIGURE		
	NUMBER	ITEM NUMBER OR REF. DESIGNATION	REFERENCE No.		NUMBER	ITEM NUMBER OR REF. DESIGNATION	REFERENCE No.
REFERENCE No.	<u>MFG. CODE</u>	<u>FIG. NO.</u>	<u>REFERENCE DESIGNATION</u>	<u>REFERENCE No.</u>	<u>MFG. CODE</u>	<u>FIG. NO.</u>	<u>REFERENCE DESIGNATION</u>
K6S	81312	3-42	1A7J3	MS35168-88E	96906		1A1P3
K6S	81312	3-42	1A7J4	MS35168-88E	96906		1A1P4
LT4K040	81349		1A4A4L36	MS35168-88E	96906		1A1P5
LT7K205	81349		1A4A3L7	MS35168-88E	96906		1A1P6
LT7K205	81349	3-2	1A4L4	MS35168-88E	96906		1A13A2W2P1
LT7K205	81349	3-2	1A4L6	MS35168-88E	96906		1A13A2W2P2
LT7K205	81349	3-2	1A4L7	MS35168-88E	96906		1A13A2W3P1
LT7K205	81349	3-2	1A4L9	MS35168-88E	96906		1A13A2W3P2
LT7K205	81349	3-2	1A4L10	MS35168-88E	96906		1A13A2W4P1
LT7K207	81349	3-38	1A3L1	MS35168-88E	96906		1A13A2W4P2
LT7K209	81349	3-17	1A4A5L5	MS35168-88E	96906		1A13A2W5P1
LT7K210	81349	3-2	1A4L13	MS35168-88E	96906		1A13A2W5P2
LT7K210	81349	3-2	1A4L12	MS35168-88E	96906		1A13A2W6P1
MF1-450PPM19-6K	19701	3-5	1A4A1R5	MS35168-88E	96906		1A13A2W6P2
MF1-450PPM23-7K	19701	3-5	1A4A1R8	MS35168-88E	96906		1A13A2W7P1
MF1-450PPM23-7K	19701	3-5	1A4A1R14	MS35168-88E	96906		1A13A2W7P2
MG1165-1	77342	3-20	1A5A7K2	MS35168-88E	96906		1A13A2W8P1
MG15567-1	96906	3-35	1A12DS1	MS35168-88E	96906		1A13A2W8P2
MS15571-2	96906	3-33	1A10I1	MS35168-88E	96906		1A13A2W10P1
MS15571-2	96906	3-52	1A6DS2	MS35168-88E	96906		1A13A2W10P2
MS15571-4	96906	3-49	1A1DS1	MS35168-88E	96906		1A13A2W27P1
MS15571-4	96906	3-52	1A6DS1	MS35168-88E	96906		1A13A2W27P2
MS25100-23	96906	3-21	1A5A7S5	MS35179-1094A	96906		1A1J3
MS25100-23	96906	3-57	1A2S2	MS35179-1094A	96906	3-2	1A4J10
MS25237-327	96906	3-3	1A4DS1	MS35179-1094A	96906	3-2	1A4J11
MS25237-327	96906	3-3	1A4DS2	MS35179-1094A	96906	3-2	1A4J12
MS25237-327	96906		1A4DS3	MS35179-1094A	96906	3-2	1A4J13
MS25237-327	96906		1A4DS4	MS35179-1094A	96906	3-2	1A4J14
MS3102A14S5S	96906	3-50	1A9J1	MS35179-1094A	96906	3-2	1A4J15
MS35059-23	96906	3-33	1A10S1	MS35179-1094A	96906	3-22	1A5A7J8
MS35059-31	96906	3-36	1A3S9	MS35179-1094A	96906	3-22	1A5A7J9

SECTION IV INDEX-FEDERAL STOCK NUMBER AND REFERENCE NUMBER CROSS REFERENCE  
TO FIGURE AND ITEM NUMBER OR REFERENCE DESIGNATION (CONTINUED)

FEDERAL STOCK NUMBER	FIGURE NUMBER			ITEM NUMBER OR REF. DESIGNATION			FEDERAL STOCK NUMBER	FIGURE NUMBER			ITEM NUMBER OR REF. DESIGNATION		
	REFERENCE NO.	MFG. CODE	FIG. NO.	REFERENCE DESIGNATION	REFERENCE NO.	MFG. CODE		FIG. NO.	REFERENCE DESIGNATION	REFERENCE NO.	MFG. CODE	FIG. NO.	REFERENCE DESIGNATION
MS35179-1094A	96906		3-22	1A5A7J10	NFTH3P1L	14655		3-2	1A4C36				
MS35179-1094A	96906		3-43	1A7J7	NFTH3P1L	14655		3-2	1A4C38				
MS35179-1094A	96906		3-48	1A8J1	NFTH3P1L	14655		3-6	1A4A3C37				
MS35179-1094A	96906		3-48	1A8J2	NS5W0104	81350		3-56	1A14E1				
MS35179-1094A	96906		3-49	1A1J2	NS5W0104	81350		3-56	1A14E2				
MS35179-1094A	96906		3-51	1A9J2	NS5W0104	81350		3-56	1A14E3				
MS35179-1094A	96906		3-53	1A6J2	NS5W0104	81350		3-56	1A14E4				
MS35179-1094A	96906		3-53	1A6J3	PD52709	72136		3-53	1A6C4				
MS35217-55	96906			1A13A1H2	PD52709	72136		3-53	1A6C6				
MS35338-82	96906			1A13H2	PX86XA6-5	45722			1A13H1				
MS35338-84	96906			1A13H1	PR7AY	77342		3-35	1A12K1				
MS51957-30	96906			1A13A2H2	P107069	56289		3-12	1A4A2C6				
MS51957-80	96906			1A13H5	P107069	56289		3-12	1A4A2C8				
MS51959-51	96906			1A13A2H4	P107069	56289		3-12	1A4A2C10				
MS51959-81	96906			1A13H6	P107069	56289		3-12	1A4A2C11				
MOD535VU	82386		3-52	1A6M1	P107069	56289		3-12	1A4A2C12				
M23-1000M	53021		3-38	1A3C15	P107069	56289		3-12	1A4A2C15				
M42000	53021		3-6	1A4A3C22	P107069	56289		3-12	1A4A2C23				
M42000	53021		3-6	1A4A3C38	P107069	56289		3-12	1A4A2C29				
NCN6-2-2-1	07886			1A10TB3	P107069	56289		3-12	1A4A2C30				
NE2	08805		3-49	1A1DS2	P107069	56289		3-12	1A4A2C31				
NE51	08805		3-36	1A3DS1	P107100	56289		3-12	1A4A2C14				
NFTH1P1L	14655			1A4A3C41	P313-0082-000	77250			1A13H7				
NFTH1P1L	14655			1A4A3C42	P50922	56289		3-46	1A11C1				
NFTH3P1L	14655		3-2	1A4C23	RC07GF153K	81349		3-54	1A6A1R7				
NFTH3P1L	14655		3-2	1A4C25	RC07GF223K	81349		3-54	1A6A1R3				
NFTH3P1L	14655		3-2	1A4C26	RC20GFK100J	81349		3-10	1A4A3A2R24				
NFTH3P1L	14655		3-2	1A4C28	RC20GF100J	81349		3-14	1A4A4R57				
NFTH3P1L	14655		3-2	1A4C31	RC20GF101J	81349		3-6	1A4A3R3				
NFTH3P1L	14655		3-2	1A4C32	RC20GF101	81349		3-10	1A4A3A2R24				
NFTH3P1L	14655		3-2	1A4C35	RC20GF101J	81349		3-17	1A4A5R2				

SECTION IV INDEX-FEDERAL STOCK NUMBER AND REFERENCE NUMBER CROSS REFERENCE  
TO FIGURE AND ITEM NUMBER OR REFERENCE DESIGNATION (CONTINUED)

FEDERAL STOCK NUMBER				FEDERAL STOCK NUMBER				
REFERENCE NO.	FIGURE NUMBER	ITEM NUMBER OR REF. DESIGNATION	REFERENCE NO.	FIGURE NUMBER	ITEM NUMBER OR REF. DESIGNATION	REFERENCE NO.	FIGURE NUMBER	ITEM NUMBER OR REF. DESIGNATION
	MFG. CODE	FIG. NO.	REFERENCE DESIGNATION		MFG. CODE	FIG. NO.	REFERENCE DESIGNATION	
RC20GF101J	81349	3-23	1A5A5R21	RC20GF103K	81349	3-6	1A4A3R28	
RC20GF101J	81349	3-23	1A5A5R31	RC20GF103K	81349	3-6	1A4A3R31	
RC20GF101J	81349	3-25	1A5A4R21	RC20GF103K	81349	3-7	1A4A3A3R5	
RC20GF101J	81349	3-29	1A5A3A1R1	RC20GF103K	81349	3-7	1A4A3A3R9	
RC20GF101J	81349	3-29	1A5A3A1R2	RC20GF103K	81349	3-8	1A4A3A6R10	
RC20GF101J	81349	3-30	1A5A3A2R1	RC20GF103K	81349	3-8	1A4A3A6R15	
RC20GF101J	81349	3-30	1A5A3A2R2	RC20GF103K	81349	3-8	1A4A3A6R16	
RC20GF101J	81349	3-31	1A5A6R20	RC20GF103K	81349	3-9	1A4A3A7R9	
RC20GF101J	81349	3-37	1A3R17	RC20GF103K	81349	3-10	1A4A3A2R7	
RC20GF101J	81349	3-38	1A3R13	RC20GF103K	81349	3-12	1A4A2R7	
RC20GF101J	81349	3-38	1A3R24	RC20GF103K	81349	3-12	1A4A2R15	
RC20GF101J	81349	3-40	1A7A1R108	RC20GF103K	81349	3-14	1A4A4R29	
RC20GF102J	81349	3-17	1A4A5R30	RC20GF103K	81349	3-14	1A4A4R36	
RC20GF102K	81349		1A4A5R25	RC20GF103K	81349	3-17	1A4A5R20	
RC20GF102K	81349	3-6	1A4A3R11	RC20GF103K	81349	3-23	1A5A5R27	
RC20GF102K	81349	3-8	1A4A3A6R20	RC20GF103K	81349	3-25	1A5A4R27	
RC20GF102K	81349	3-14	1A4A4R1					
RC20GF102K	81349	3-14	1A4A4R2	RC20GF103K	81349	3-31	1A5A6R25	
RC20GF102K	81349	3-14	1A4A4R11	RC20GF103K	81349	3-31	1A5A6R26	
RC20GF102K	81349	3-14	1A4A4R12	RC20GF103K	81349	3-53	1A6R26	
RC20GF102K	81349	3-14	1A4A4R17	RC20GF104K	81349		1A5A7R13	
RC20GF102K	81349	3-14	1A4A4R25	RC20GF104K	81349	3-8	1A4A3A6R3	
RC20GF102K	81349	3-14	1A4A4R40	RC20GF104K	81349	3-10	1A4A3A2R27	
RC20GF102K	81349	3-14	1A4A4R56	RC20GF104K	81349	3-12	1A4A2R10	
RC20GF102K	81349	3-17	1A4A5R17	RC20GF104K	81349	3-12	1A4A2R14	
RC20GF102K	81349	3-17	1A4A5R39	RC20GF104K	81349	3-12	1A4A2R16	
RC20GF102K	81349	3-24	1A5A5R1	RC20GF104K	81349	3-14	1A4A4R19	
RC20GF102K	81349	3-26	1A5A4R1	RC20GF104K	81349	3-14	1A4A4R21	
RC20GF102K	81349	3-32	1A5A6R1	RC20GF104K	81349	3-14	1A4A4R24	
RC20GF103K	81349	3-27	1A5A2R2	RC20GF104K	81349	3-14	1A4A4R27	
RC20GF103K	81349	3-6	1A4A3R6	RC20GF104K	81349	3-14	1A4A4R32	
RC20GF103K	81349	3-6	1A4A3R10					



SECTION IV INDEX-FEDERAL STOCK NUMBER AND REFERENCE NUMBER CROSS REFERENCE  
TO FIGURE AND ITEM NUMBER OR REFERENCE DESIGNATION (CONTINUED)

FEDERAL STOCK NUMBER	FIGURE NUMBER		ITEM NUMBER OR REF. DESIGNATION	FEDERAL STOCK NUMBER	FIGURE NUMBER		ITEM NUMBER OR REF. DESIGNATION
	MFG. CODE	FIG. NO.	REFERENCE DESIGNATION		MFG. CODE	FIG. NO.	REFERENCE DESIGNATION
RC20GF104K	81349	3-17	1A4A5R19	RC20GF151K	81349	3-25	1A5A4R31
RC20GP104K	81349	3-17	1A4A5R27	RC20GF151K	81349	3-26	1A5A4R3
RC20GF104K	81349	3-17	1A4A5R32	RC20GF151K	81349	3-31	1A5A6R9
RC20GF104K	81349	3-23	1A5A5R10	RC20GF151K	81349	3-31	1A5A6R30
RC20GF104K	81349	3-25	1A5A4R10	RC20GF151K	81349	3-32	1A5A6R7
RC20GF104K	81349	3-31	1A5A6R23	RC20GF151K	81349	3-42	1A7R3
RC20GF104K	81349	3-37	1A3R29	RC20GF151K	81349	3-42	1A7R4
RC20GF104K	81349	3-53	1A6R6	RC20GF151K	81349	3-42	1A7R5
RC20GF104K	81349	3-53	1A6R9	RC20GF151K	81349	3-42	1A7R6
RC20GF105K	81349	3-14	1A4A4R34	RC20GF151K	81349	3-43	1A7R11
RC20GF105K	81349	3-19	1A5A1R3	RC20GF151K	81349	3-43	1A7R12
RC20GF105K	81349	3-20	1A5A7R7	RC20GF151K	81349	3-43	1A7R14
RC20GF105K	81349	3-23	1A5A5R26	RC20GF151K	81349	3-43	1A7R15
RC20GF105K	81349	3-25	1A5A4R26	RC20GF152K	81349	3-7	1A4A3A3R10
RC20GF105K	81349	3-27	1A5A2R1	RC20GF153J	81349	3-2	1A4R5
RC20GF105K	81349	3-48	1A8R3	RC20GF153J	81349	3-6	1A4A3R4
RC20GF113J	81349	3-27	1A5A2R2	RC20GF153J	81349	3-6	1A4A3R22
RC20GF121K	81349	3-14	1A4A4R4	RC20GF153J	81349	3-6	1A4A3R29
RC20GF121K	81349	3-43	1A7R27	RC20GF153J	81349	3-7	1A4A3A3R11
RC20GF123J	81349	3-27	1A5A2R2	RC20GF153J	81349	3-8	1A4A3A6R14
RC20GF123K	81349	3-8	1A4A3A6R5	RC20GF153J	81349	3-9	1A4A3A7R14
RC20GF123K	81349	3-53	1A6R25	RC20GF153J	81349	3-12	1A4A2R12
RC20GF124K	81349	3-8	1A4A3A6R8	RC20GF153J	81349	3-27	1A5A2R2
RC20GF124K	81349	3-12	1A4A2R15	RC20GF153J	81349	3-28	1A5A2R7
RC20GF133J	81349	3-27	1A5A2R2	RC20GF153J	81349	3-28	1A5A2R10
RC20GF134J	81349	3-12	1A4A2R15	RC20GF154K	81349		1A5A4R32
RC20GF150J	81349	3-6	1A4A3R20	RC20GF154K	81349		1A5A5R32
RC20GF150J	81349	3-53	1A6R21	RC20GF154K	81349		1A5A6R32
RC20GF151K	81349	3-19	1A5A1R4	RC20GF154K	81349	3-12	1A4A2R15
RC20GF151K	81349	3-23	1A5A5R31	RC20GF154K	81349	3-14	1A4A4R35
RC20GF151K	81349	3-24	1A5A5R3	RC20GF154K	81349	3-24	1A5A5R16

SECTION IV INDEX-FEDERAL STOCK NUMBER AND REFERENCE NUMBER CROSS REFERENCE  
TO FIGURE AND ITEM NUMBER OR REFERENCE DESIGNATION (CONTINUED)

FEDERAL STOCK NUMBER	FIGURE NUMBER		ITEM NUMBER OR REF. DESIGNATION		FEDERAL STOCK NUMBER	FIGURE NUMBER		ITEM NUMBER OR REF. DESIGNATION	
	REFERENCE NO.	MFG. CODE	FIG. NO.	REFERENCE DESIGNATION		REFERENCE NO.	MFG. CODE	FIG. NO.	REFERENCE DESIGNATION
RC20GF154K	81349		3-26	1A5A4R16	RC20GF220K	81349	3-23	1A5A5R22	
RC20GF154K	81349		3-32	1A5A6R15	RC20GF220K	81349	3-23	1A5A5R23	
RC20GF163J	81349		3-27	1A5A2R2	RC20GF220K	81349	3-25	1A5A4R22	
RC20GF164J	81349		3-12	1A4A2R15	RC20GF220K	81349	3-25	1A5A4R23	
RC20GF181K	81349		3-23	1A5A5R31	RC20GF220K	81349	3-31	1A5A6R21	
RC20GF181K	81349		3-25	1A5A4R31	RC20GF220K	81349	3-31	1A5A6R22	
RC20GF181K	81349		3-31	1A5A6R30	RC20GF221K	81349	3-9	1A4A3A7R1	
RC07GF182K	81349		3-9	1A4A3A7R6	RC20GF221K	81349	3-10	1A4A3A2R14	
RC20GF183J	81349		3-27	1A5A2R2	RC20GF221K	81349	3-10	1A4A3A2R17	
RC20GF183K	81349		3-5	1A4A1R16	RC20GF221K	81349	3-23	1A5A5R31	
RC20GF183K	81349		3-9	1A4A3A7R2	RC20GF221K	81349	3-25	1A5A4R31	
RC20GF183K	81349		3-10	1A4A3A2R13	RC20GF221K	81349	3-31	1A5A6R30	
RC20GF183K	81349		3-10	1A4A3A2R16	RC20GF222K	81349		1A4A5R40	
RC20GF183K	81349		3-10	1A4A3A2R21	RC20GF222K	81349	3-6	1A4A3R15	
RC20GF183K	81349		3-12	1A4A2R15	RC20GF222K	81349	3-6	1A4A3R18	
RC20GF183K	81349		3-12	1A4A2R19	RC20GF222K	81349	3-8	1A4A3A6R11	
RC20GF183K	81349		3-14	1A4A4R7	RC20GF222K	81349	3-12	1A4A2R20	
RC20GF183K	81349		3-14	1A4A4R18	RC20GF222K	81349	3-17	1A4A5R37	
RC20GF183K	81349		3-14	1A4A4R26	RC20GF222K	81349	3-29	1A5A3A1R14	
RC20GF183K	81349		3-17	1A4A5R36	RC20GF222K	81349	3-30	1A5A3A2R14	
RC20GF183K	81349		3-32	1A5A6R12	RC20GF222K	81349	3-45	1A7A4R203	
RC20GF184K	81349			1A5A4R32	RC20GF223J	81349	3-27	1A5A2R2	
RC20GF184K	81349			1A5A5R32	RC20GF222K	81349	3-45	1A7A4R204	
RC20GF184K	81349			1A5A6R32	RC20GF223K	81349		1A4A3R33	
RC20GF184K	81349		3-10	1A4A3A2R6	RC20GF223K	81349		1A4A3A6R17	
RC20GF184K	81349		3-12	1A4A2R15	RC20GF223K	81349	3-8	1A4A3A6R12	
RC20GF184K	81349		3-23	1A5A5R15	RC20GF223K	81349	3-14	1A4A4R55	
RC20GF184K	81349		3-25	1A5A4R15	RC20GF223K	81349	3-23	1A5A5R2	
RC20GF184K	81349		3-31	1A5A6R14	RC20GF223K	81349	3-23	1A5A5R5	
RC20GF184K	81349		3-53	1A6R16	RC20GF223K	81349	3-25	1A5A4R2	
RC20GF203J	81349		3-27	1A5A2R2	RC20GF223K	81349	3-25	1A5A4R5	

SECTION IV INDEX-FEDERAL STOCK NUMBER AND REFERENCE NUMBER CROSS REFERENCE  
TO FIGURE AND ITEM NUMBER OR REFERENCE DESIGNATION (CONTINUED)

FEDERAL STOCK NUMBER	FIGURE NUMBER		ITEM NUMBER OR REF. DESIGNATION	FEDERAL STOCK NUMBER	FIGURE NUMBER		ITEM NUMBER OR REF. DESIGNATION
	REFERENCE NO.	MFG. CODE	FIG. NO.		REFERENCE DESIGNATION	REFERENCE NO.	MFG. CODE
RC20GF223K	81349	3-27	1A5A2R4	RC20GF274K	81349	3-53	1A6R10
RC20GF223K	81349	3-31	1A5A6R2	RC20GF331K	81349	3-6	1A4A3R8
RC20GF223K	81349	3-31	1A5A6R5	RC20GF331K	81349	3-6	1A4A3R16
RC20GF223K	81349	3-53	1A6R7	RC20GF331K	81349	3-6	1A4A3R17
RC20GF224K	81349	3-7	1A4A3A3R1	RC20GF331K	81349	-23	1A5A5R12
RC20GF224K	81349	3-17	1A4A5R34	RC20GF331K	81349	3-25	1A5A4R12
RC20GF224K	81349	3-19	1A5A1R1	RC20GF331K	81349	3-25	1A5A4R31
RC20GF224K	81349	3-19	1A5A1R2	RC20GF331K	81349	3-29	1A5A3A1R13
RC20GF224K	81349	3-20	1A5A7R5	RC20GF331K	81349	3-30	1A5A3A2R13
RC20GF225K	81349	3-5	1A4A1R1	RC20GF331K	81349	3-31	1A5A6R30
RC20GF243J	81349	3-27	1A5A2R2	RC20GF333J	81349	3-27	1A5A2R2
RC20CF270K	81349	3-10	1A4A3A2R24	RC20GF333K	81349	3-9	1A4A3A7R13
RC20GF271K	81349	3-14	1A4A4R38	RC20GF333K	81349	3-12	1A4A2R2
RC20GF271K	81349	3-23	1A5A5R31	RC20GF333K	81349	3-12	1A4A2R15
RC20GF271K	81349	3-25	1A5A4R31	RC20GF333K	81349	3-24	1A5A5R28
RC20CF271K	81349	3-31	1A5A6R30	RC20GF333K	81349	3-26	1A5A4R28
RC20GF271K	81349	3-51	1A9R1	RC20GF333K	81349	3-40	1A7A1R102
RC20GF272J	81349	3-5	1A4A1R18	RC20GF333K	81349	3-53	1A6R3
RC20GF272K	81349	3-11	1A4A3A8R2	RC20GF334K	81349	3-12	1A4A2R4
RC20GF272K	81349	3-11	1A4A3A8R3	RC20GF334K	81349	3-12	1A4A2R5
RC20GF272K	81349	3-17	1A4A5R21	RC20GF334K	81349	3-12	1A4A2R15
RC20GF273J	81349	3-27	1A5A2R2	RC20GF334K	81349	3-31	1A5A6R24
RC20GF273K	81349	3-5	1A4A1R11	RC20GF334K	81349	3-40	1A7A1R110
RC20GF273K	81349	3-12	1A4A2R15	RC20GF335K	81349	3-14	1A4A4R60
RC20GF273K	81349	3-12	1A4A2R17	RC20CF390K	81349	3-10	1A4A3A2R24
RC20GF273K	81349	3-32	1A5A6R8	RC20GF390K	81349	3-38	1A3R3
RC20GF273K	81349	3-37	1A3R23	RC20GF391K	81349	3-23	1A5A5R31
RC20GF273K	81349	3-53	1A6R28	RC20GF391K	81349	3-25	1A5A4R31
RC20GF274K	81349	3-9	1A4A3A7R12	RC20GF391K	81349	3-31	1A5A6R30
RC20GF274K	81349	3-12	1A4A2R15	RC20GF391K	81349	3-43	1A7R8
RC20GF274K	81349	3-37	1A3R39	RC20GF391K	81349	3-43	1A7R9

SECTION IV INDEX-FEDERAL STOCK NUMBER AND REFERENCE NUMBER CROSS REFERENCE  
TO FIGURE AND ITEM NUMBER OR REFERENCE DESIGNATION (CONTINUED)

FEDERAL STOCK NUMBER	FIGURE NUMBER		ITEM NUMBER OR REF. DESIGNATION	FEDERAL STOCK NUMBER	FIGURE NUMBER		ITEM NUMBER OR REF. DESIGNATION
	MFG. CODE	FIG. NO.	REFERENCE DESIGNATION		REFERENCE NO.	MFG. CODE	FIG. NO.
RC20GF391K	81349	3-53	1A6R4	RC20GF471K	81349	3-31	1A5A6R30
RC20GF391K	81349	3-53	1A6R15	RC20GF471K	81349	3-49	1A1R1
RC20GF392K	81349	3-14	1A4A4R58	RC20GF472J	81349	3-17	1A4A5R28
RC20GF393J	81349	3-27	1A5A2R2	RC20GF472K	81349		1A4A4R66
RC20GF393K	81349		1A4A5R24	RC20GF472K	81349	3-12	1A4A2R1
RC20GF393K	81349	3-7	1A4A3A3R4	RC20GF472K	81349	3-17	1A4A5R3
RC20GF393K	81349	3-12	1A4A2R15	RC20GF472K	81349	3-17	1A4A5R13
RC20GF393K	81349	3-17	1A4A5R14	RC20GF472K	81349	3-17	1A4A5R15
RC20GF393K	81349	3-17	1A4A5R16	RC20GF472K	81349	3-17	1A4A5R18
RC20GF393K	81349	3-31	1A5A6R13	RC20GF472K	81349	3-17	1A4A5R23
RC20GF393K	81349	3-53	1A6R2	RC20GF472K	81349	3-17	1A4A5R26
RC20GF433J	81349	3-27	1A5A2R2	RC20GF472K	81349	3-17	1A4A5R31
RC20GF470K	81349	3-10	1A4A3A2R24	RC20GF472K	81349	3-17	1A4A5R33
RC20GF470K	81349	3-14	1A4A4R13	RC20GF472K	81349	3-17	1A4A5R35
RC20GF470K	81349	3-17	1A4A5R5	RC20GF472K	81349	3-25	1A7A1R103
RC20GF470K	81349	3-28	1A5A2R8	RC20GF472K	81349	3-40	1A7A1R105
RC20GF470K	81349	3-48	1A8R4	RC20GF472K	81349	3-10	1A4A3A2R25
RC20GF471K	81349	3-7	1A4A3A3R3	RC20GF473J	81349	3-10	1A4A3A2R26
RC20GF471K	81349	3-7	1A4A3A3R8	RC20GF473K	81349		1A4A3A2R25
RC20GF471K	81349	3-12	1A4A2R6	RC20GF473K	81349		1A4A3A2R26
RC20GF471K	81349	3-12	1A4A2R18	RC20GF473K	81349		1A6R8
RC20GF471K	81349	3-23	1A5A5R31	RC20GF473K	81349	3-6	1A4A3R7
RC20GF471K	81349	3-25	1A5A4R31	RC20GF473K	81349	3-6	1A4A3R9
RC20GF471K	81349	3-29	1A5A3A1R3	RC20GF473K	81349	3-7	1A4A3A3R7
RC20GF471K	81349	3-29	1A5A3A1R4	RC20GF473K	81349	3-12	1A4A2R15
RC20GF471K	81349	3-29	1A5A3A1R5	RC20GF473K	81349	3-23	1A5A5R30
RC20GF471K	81349	3-29	1A5A3A1R6	RC20GF473K	81349	3-24	1A5A5R9
RC20GF471K	81349	3-30	1A5A3A2R3	RC20GF473K	81349	3-24	1A5A5R13
RC20GF471K	81349	3-30	1A5A3A2R4	RC20GF473K	81349	3-25	1A5A4R30
RC20GF471K	81349	3-30	1A5A3A2R5	RC20GF473K	81349	3-26	1A5A4R9
RC20GF471K	81349	3-30	1A5A3A2R6	RC20GF473K	81349	3-26	1A5A4R13

TM 11-5820-555-24P  
SECTION IV INDEX-FEDERAL STOCK NUMBER AND REFERENCE NUMBER CROSS REFERENCE  
TO FIGURE AND ITEM NUMBER OR REFERENCE DESIGNATION (CONTINUED)

FEDERAL STOCK NUMBER	FIGURE NUMBER		ITEM NUMBER OR REF. DESIGNATION		FEDERAL STOCK NUMBER	FIGURE NUMBER		ITEM NUMBER OR REF. DESIGNATION	
	REFERENCE NO.	MFG. CODE	FIG. NO.	REFERENCE DESIGNATION		REFERENCE No.	MFG. CODE	FIG. NO.	REFERENCE DESIGNATION
RC20GF473K	81349	3-38	1A3R2		RC20GF563J	81349	3-28	1A5A2R12	
RC20GF473K	81349	3-53	1A6R1		RC20GF563J	81349	3-40	1A7A1R101	
RC20GF474K	81349	3-12	1A4A2R15		RC20GF564K	81349	3-12	1A4A2R15	
RC20GF474K	81349	3-14	1A4A4R3		RC20GF564K	81349	3-36	1A3R36	
RC20GF474K	81349	3-14	1A4A4R8		RC20GF680K	81349	3-9	1A4A3A7R3	
RC20GF474K	81349	3-14	1A4A4R10		RC20GF680K	81349	3-10	1A4A3A2R19	
RC20GF474K	81349	3-14	1A4A4R23		RC20GF680K	81349	3-10	1A4A3A2R24	
RC20GF474K	81349	3-14	1A4A4R31		RC20GF680K	81349	3-14	1A4A4R9	
RC20GF474K	81349	3-14	1A4A4R37		RC20GF680K	81349	3-14	1A4A4R15	
RC20GF474K	81349	3-20	1A5A7R6		RC20GF680K	81349	3-14	1A4A4R22	
RC20GF474K	81349	3-20	1A5A7R10		RC20GF680K	81349	3-14	1A4A4R30	
RC20GF512J	81349	3-5	1A4A1R2		RC20GF680K	81349	3-14	1A4A4R62	
RC20GF560K	81349	3-10	1A4A3A2R24		RC20GF681K	81349	3-8	1A4A3A6R13	
RC20GF561K	81349	3-23	1A5A5R31		RC20GF681K	81349	3-23	1A5A5R31	
RC20GF561K	81349	3-43	1A7R26		RC29GF681K	81349	3-25	1A5A4R31	
RC20GF562K	81349	3-9	1A4A3A7R10		RC20GF681K	81349	3-31	1A5A6R30	
RC20GF562K	81349	3-9	1A4A3A7R8		RC20GF681K	81349	3-48	1A8R10	
RC20GF562K	81349	3-10	1A4A3A2R8		RC20GF681K	81349	3-51	1A9R2	
RC20GF562K	81349	3-10	1A4A3A2R12		RC20GF682K	81349	3-6	1A4A3R21	
RC20GF562K	81349	3-10	1A4A3A2R18		RC20GF682K	81349	3-8	1A4A3A6R7	
RC20GF562K	81349	3-12	1A4A2R8		RC20GF682K	81349	3-9	1A4A3A7R15	
RC20GF562K	81349	3-17	1A4A5R22		RC20GF682K	81349	3-10	1A4A3A2R15	
RC20GF562K	81349	3-28	1A5A2R11		RC20GF682K	81349	3-12	1A4A2R9	
RC20GF563J	81349	3-8	1A4A3A6R4		RC20GF682K	81349	3-12	1A4A2R21	
RC20GF563J	81349	3-10	1A4A3A2R30		RC20GF682K	81349	3-17	1A4A5R4	
RC20GF563J	81349	3-12	1A4A2R13		RC20GF682K	81349	3-24	1A5A5R17	
RC20GF563J	81349	3-20	1A5A7R22		RC20GF682K	81349	3-26	1A5A4R17	
RC20GF563J	81349	3-20	1A5A7R23		RC20GF682K	81349	3-32	1A5A6R16	
RC20GF563J	81349	3-20	1A5A7R24		RC20GF682K	81349	3-40	1A7A1R104	
RC20GF563J	81349	3-23	1A5A5R24		RC20GF682K	81349	3-53	1A6R27	
RC20GF563J	81349	3-25	1A5A4R24		RC20GF683J	81349	3-12	1A4A2R3	

SECTION IV INDEX-FEDERAL STOCK NUMBER AND REFERENCE NUMBER CROSS REFERENCE  
TO FIGURE AND ITEM NUMBER OR REFERENCE DESIGNATION (CONTINUED)

FEDERAL STOCK NUMBER	FIGURE NUMBER		ITEM NUMBER OR REF. DESIGNATION	FEDERAL STOCK NUMBER	FIGURE NUMBER		ITEM NUMBER OR REF. DESIGNATION
	REFERENCE NO.	MFG. CODE	FIG. NO. REFERENCE DESIGNATION		REFERENCE NO.	MFG. CODE	FIG. NO. REFERENCE DESIGNATION
RC20GF683J	81349	3-12	1A4A2R11	RC32GF102K	81349	3-14	1A4A4R6
RC20GF683J	81349	3-12	1A4A2R15	RC32GF102K	81349	3-43	1A7R28
RC20GF683J	81349	3-31	1A5A6R29	RC32GF123K	81349	3-34	1A1OR8
RC20GF683J	81349	3-32	1A5A6R11	RC32GF151K	81349		1A5A7R21
RC20GF683J	81349	3-37	1A3R22	RC32GF151K	81349	3-20	1A5A7R20
RC20GF683J	81349	3-54	1A6A1R1	RC32GF153K	81349	3-24	1A5A5R14
RC20GF753J	81349	3-12	1A4A2R15	RC32GF153K	81349	3-26	1A5A4R14
RC20GF820K	81349	3-10	1A4A3A2R24	RC32GF183K	81349	3-53	1A6R5
RC20GF820K	81349	3-14	1A4A4R59	RC32GF183K	81349	3-53	1A6R14
RC20GF820K	81349	3-23	1A5A5R6	RC32GF202J	81349	3-23	1A5A5R19
RC20GF820K	81349	3-25	1A5A4R6	RC32GF202J	81349	3-25	1A5A4R19
RC20GF820K	81349	3-31	1A5A6R6	RC32GF202J	81349	3-31	1A5A6R18
RC20GF821K	81349	3-10	1A4A3A2R10	RC32GF220K	81349	3-17	1A4A5R1
RC20GF821K	81349	3-10	1A4A3A2R31	RC32GF220K	81349	3-53	1A6R13
RC20GF821K	81349	3-20	1A5A7R8	RC32GF221K	81349	3-38	1A3R6
RC20GF821K	81349	3-20	1A5A7R9	RC32GF223K	81349	3-6	1A4A3R13
RC20GF821K	81349	3-27	1A5A2R5	RC32GF271K	81349	3-5	1A4A1R17
RC20GF821K	81349	3-53	1A6R20	RC32GF272K	81349	3-43	1A7R7
RC20GF822K	81349	3-7	1A4A3A3R6	RC32GF331J	81349	3-11	1A4A3A8R6
RC20GF823K	81349	3-6	1A4A3R32	RC32GF333K	81349	3-6	1A4A3R23
RC20GF823K	81349	3-7	1A4A3A3R2	RC32GF392K	81349	3-19	1A5A1R5
RC20GF823K	81349	3-12	1A4A2R15	RC32GF393K	81349	3-6	1A4A3R14
RC20GF823K	81349	3-37	1A3R21	RC32GF393K	81349	3-32	1A5A6R27
RC20GF823K	81349	3-53	1A6R12	RC32GF471K	81349	3-3	1A4R1
RC20GF823K	81349	3-53	1A6R17	RC32GF471K	81349	3-3	1A4R2
RC20GF824K	81349	3-27	1A5A2R3	RC32GF471K	81349		1A4R3
RC20GF825K	81349		1A5A7R19	RC32GF471K	81349		1A4R4
RC32GF100K	81349		1A2R1	RC32GF473K	81349	3-6	1A4A3R5
RC32GF100K	81349		1A2R2	RC32GF473K	81349	3-53	1A6R11
RC32GF101K	81349	3-20	1A5A7R25	RC32GF561K	81349	3-11	1A4A3A8R5
RC32GF101K	81349	3-34	1A1OR5	RC32GF562K	81349	3-23	1A5A5R4

SECTION IV INDEX-FEDERAL STOCK NUMBER AND REFERENCE NUMBER CROSS REFERENCE  
TO FIGURE AND ITEM NUMBER OR REFERENCE DESIGNATION (CONTINUED)

FEDERAL STOCK NUMBER	FIGURE NUMBER		ITEM NUMBER OR REF. DESIGNATION	FEDERAL STOCK NUMBER	FIGURE NUMBER		ITEM NUMBER OR REF. DESIGNATION
	REFERENCE NO.	MFG. CODE	FIG. NO. REFERENCE DESIGNATION		REFERENCE NO.	MFG. CODE	FIG. NO. REFERENCE DESIGNATION
RC32GF562K	81349	3-23	1A5A5R7	RC42GF222K	81349	3-14	1A4A4R5
RC32GF562K	81349	3-23	1A5A5R29	RC42GF222K	81349	3-14	1A4A4R20
RC32GF562K	81349	3-25	1A5A4R4	RC42GF222K	81349	3-14	1A4A4R33
RC32GF562K	81349	3-25	1A5A4R7	RC42GF274K	81349	3-38	1A3R37
RC32GF562K	81349	3-25	1A5A4R29	RC42GF331K	81349		1A9R4
RC32GF562K	81349	3-31	1A5A6R4	RC42GF332K	81349	3-14	1A4A4R39
RC32GF562K	81349	3-31	1A5A6R7	RC42GF333K	81349	3-34	1A10R4
RC32GF562K	81349	3-31	1A5A6R28	RC42GF391K	81349	3-23	1A5A5R20
RC32GF562K	81349	3-32	1A5A6R10	RC42GF391K	81349	3-25	1A5A4R20
RC32GF562K	81349	3-48	1A8R9	RC42GF391K	81349	3-31	1A5A6R19
RC32GF680K	81349	3-53	1A6R30	RC42GF392K	81349	3-14	1A4A4R28
RC32GF682K	81349	3-6	1A4A3R2	RC42GF470K	81349	3-14	1A4A4R63
RC32GF822K	81349	3-6	1A4A3R9	RC42GF472J	81349	3-37	1A3R20
RC42GF101K	81349	3-34	1A10R2	RC42GF560K	81349	3-38	1A3R1
RC42GF101K	81349	3-38	1A3R11	RC42GF562K	81349	3-34	1A10R6
RC42GF101K	81349	3-38	1A3R12	RC42GF683K	81349	3-38	1A3R48
RC42GF101K	81349	3-38	1A3R25	RC42GF822K	81349	3-38	1A3R4
RC42GF103K	81349		1A5A7R31	RF0235	94375		1A13A2W1P1
RC42GF104J	81349	3-34	1A10R3	RF0235	94375		1A13A2W1P2
RC42GF104J	81349	3-37	1A3R15	RF0235	94375	3-58	1A2P4
RC42GF104J	81349	3-37	1A3R30	RN20X12R1F	81349		1A2A1R1
RC42GF104J	81349	3-37	1A3R31	RN20X12R1F	81349		1A2A1R2
RC42GF104J	81349	3-37	1A3R32	RN56D6191F	81349		1A2A1R3
RC42GF104J	81349	3-37	1A3R33	RN56D6191F	81349		1A2A1R4
RC42GF104J	81349	3-37	1A3R34	RN60C5110F	81349	3-29	1A5A3A1R11
RC42GF104J	81349	3-37	1A3R35	RN60C5110F	81349	3-29	1A5A3A1R12
RC42GF123K	81349	3-34	1A10R7	RN60C5110F	81349	3-30	1A5A3A2R11
RC42GF153K	81349		1A4A4R65	RN60C5110F	81349	3-30	1A5A3A2R12
RC42GF153K	81349	3-14	1A4A4R16	RN65D1001F	81349		1A2A1R5
RC42GF181K	81349	3-51	1A9R3	RN65D1001F	81349		1A2A1R6
RC42GF182K	81349		1A13R1	RN65D1002F	81349		1A2A1R3

SECTION IV INDEX-FEDERAL STOCK NUMBER AND REFERENCE NUMBER CROSS REFERENCE  
TO FIGURE AND ITEM NUMBER OR REFERENCE DESIGNATION (CONTINUED)

FEDERAL STOCK NUMBER	FIGURE NUMBER		ITEM NUMBER OR REF. DESIGNATION		FEDERAL STOCK NUMBER	FIGURE NUMBER		ITEM NUMBER OR REF. DESIGNATION	
	REFERENCE NO.	MFG. CODE	FIG. NO.	REFERENCE DESIGNATION		REFERENCE NO.	MFG. CODE	FIG. NO.	REFERENCE DESIGNATION
RN65D1002F	81349			1A2A1R4	RN65D2612F	81349	3-5		1A4A1R9
RN65D1002F	81349		3-10	1A4A3A2R5	RN65D2612F	81349	3-5		1A4A1R13
RN65D1002F	81349		3-48	1A8R6	RN65D2870F	81349	3-9		1A4A3A7R11
RN65D1051F	81349			1A2A1R5	RN65D3010F	81349	3-43		1A7R17
RN65D1051F	81349			1A2A1R6	RN65D3010F	81349	3-43		1A7R18
RN65D1101F	81349			1A2A1R5	RN65D3010F	81349	3-43		1A7R19
RN65D1101F	81349			1A2A1R6	RN65D3010F	81349	3-43		1A7R20
RN65D1102F	81349		3-38	1A3R27	RN65D3010F	81349	3-43		1A7R22
RN65D1151F	81349			1A2A1R5	RN65D3010F	81349	3-43		1A7R23
RN65D1151F	81349			1A2A1R6	RN65D3010F	81349	3-43		1A7R24
RN65D1211F	81349			1A2A1R5	RN65D3010F	81349	3-43		1A7R25
RN65D1211F	81349			1A2A1R6	RN65D4221F	81349			1A4A3A2F9
RN65D1271F	81349			1A2A1R5	RN65D4640F	81349	3-10		1A4A3A2R4
RN65D1271F	81349			1A2A1R6	RN65D4641F	81349	3-5		1A4A1R3
RN65D1331F	81349			1A2A1R5	RN65D4641F	81349	3-5		1A4A1R6
RN65D1331F	81349			1A2A1R6	RN65D4641F	81349	3-5		1A4A1R7
RN65D1332F	81349		3-53	1A6R24	RN65D4641F	81349	3-5		1A4A1R10
RN65D1401F	81349			1A2A1R5	RN65D4641F	81349	3-5		1A4A1R12
RN65D1401F	81349			1A2A1R6	RN65D4641F	81349	3-5		1A4A1R15
RN65D1471F	81349			1A2A1R5	RN65D4642F	81349	3-53		1A6R29
RN65D1471F	81349			1A2A1R6	RN65D4751F	81349			1A2A1R3
RN65D1471F	81349		3-48	1A8R7	RN65D4751F	81349			1A2A1R4
RN65D1541F	81349			1A2A1R5	RN65D4871F	81349			1A2A1R3
RN65D1541F	81349			1A2A1R6	RN65D4871F	81349			1A2A1R4
RN65D1783F	81349			1A5A7R17	RN65D4991F	81349			1A2A1R3
RN65D2151F	81349		3-20	1A5A7R11	RN65D4991F	81349			1A2A1R4
RN65D2152F	81349		3-10	1A4A3A2R28	RN65D5111F	81349			1A2A1R3
RN65D2152F	81349		3-10	1A4A3A2R29	RN65D5111F	81349			1A2A1R4
RN65M2152F	81349		3-38	1A3R26	RN65D5231F	81349			1A2A1R3
RN65D2152F	81349		3-38	1A3R28	RN65D5231F	81349			1A2A1R4
RN65D2612F	81349		3-5	1A4A1R4	RN65D5361F	81349			1A2A1R3



SECTION IV INDEX-FEDERAL STOCK NUMBER AND REFERENCE NUMBER CROSS REFERENCE  
TO FIGURE AND ITEM NUMBER OR REFERENCE DESIGNATION (CONTINUED)

FEDERAL STOCK NUMBER	FIGURE NUMBER	ITEM NUMBER OR REF. DESIGNATION	FEDERAL STOCK NUMBER	FIGURE NUMBER	ITEM NUMBER OR REF. DESIGNATION
REFERENCE NO.	MFG. CODE	FIG. NO. REFERENCE DESIGNATION	REFERENCE NO.	MFG. CODE	FIG. NO. REFERENCE DESIGNATION
RN65D5361F	81349	1A2A1R4	RN65D7501F	81349	3-9 1A4A3A7R5
RN65D5491F	81349	1A2A1R3	RN65D7681F	81349	1A2A1R3
RN65D5491F	81349	1A2A1R4	RN65D7681F	81349	1A2A1R4
RN65D5621F	81349	1A2A1R3	RN65D7871F	81349	1A2A1R3
RN65D5621F	81349	1A2A1R4	RN65D7871F	81349	1A2A1R4
RN65D5761F	81349	1A2A1R3	RN65D8061F	81349	1A2A1R3
RN65D5761F	81349	1A2A1R4	RN65D8061F	81349	1A2A1R4
RN65D5901F	81349	1A2A1R3	RN65D8250F	81349	3-53 1A6R22
RN65D5901F	81349	1A2A1R4	RN65D8251F	81349	1A2A1R3
RN65D6041F	81349	1A2A1R3	RN65D8251F	81349	1A2A1R4
RN65D6041F	81349	1A2A1R4	RN65D8451F	81349	1A2A1R3
RN65D6191F	81349	3-11 1A4A3A8R7	RN65D8451F	81349	1A2A1R4
RN65D6341F	81349	1A2A1R3	RN65D8661F	81349	1A2A1R3
RN65D6341F	81349	1A2A1R4	RN65DB661F	81349	1A2A1R4
RN65D6491F	81349	1A2A1R3	RN65D8871F	81349	1A2A1R3
BN65D6491F	81349	1A2A1R4	RN65D8871F	81349	1A2A1R4
RN65W6491F	81349	3-53 1A6R23	RN65D9091F	81349	1A2A1R3
RN65D6651F	81349	1A2A1R3	RN65D9091F	81349	1A2A1R4
RN65D6651F	81349	1A2A1R4	RN65D9311F	81349	1A2A1R3
RN65D6811F	81349	1A2A1R3	RN65D9311F	81349	1A2A1R4
RN65D6811F	81349	1A2A1R4	RN65D9531F	81349	1A2A1R3
RN65D6811F	81349	3-48 1A8R5	RN65D9531F	81349	1A2A1R4
RN65D6981F	81349	1A2A1R3	RN65D9761F	81349	1A2A1R3
RN65D6981F	81349	1A2A1R4	RN65D9761F	81349	1A2A1R4
RN65D7151F	81349	1A2A1R3	RN70D1541F	81349	3-38 1A3R9
RN65D7151F	81349	1A2A1R4	RN70D1541F	81349	3-38 1A3R10
RN65D7321F	81349	1A2A1R3	RN70D2613F	81349	3-20 1A5A7R12
RN65D7321F	81349	1A2A1R4	RN70D5113F	81349	3-20 1A5A7R18
RN65D7500F	81349	3-10 1A4A3A2R11	RN80B1151F	81349	3-48 1A8R1
RN65D7501F	81349	1A2A1R3	RSM2-150ROG	91637	3-40 1A7A1R106
RN65D7501F	81349	1A2A1R4	RSM2R0700G	91637	3-38 1A3R14

SECTION IV INDEX-FEDERAL STOCK NUMBER AND REFERENCE NUMBER CROSS REFERENCE  
TO FIGURE AND ITEM NUMBER OR REFERENCE DESIGNATION (CONTINUED)

FEDERAL STOCK NUMBER	FIGURE NUMBER		ITEM NUMBER OR REF. DESIGNATION		FEDERAL STOCK NUMBER	FIGURE NUMBER		ITEM NUMBER OR REF. DESIGNATION	
	REFERENCE NO.	MFG. CODE	FIG. NO.	REFERENCE DESIGNATION		REFERENCE NO.	MFG. CODE	FIG. NO.	REFERENCE DESIGNATION
RS2-2R000F	91637	3-38	1A3R7		R842-24	01686	3-30	1A5A3A2R9	
RS2-2R000F	91637	3-38	1A3R8		R842-24	01686	3-29	1A5A3A2R10	
RS2C5R000J	91637	3-17	1A4A5R6		SCDM15C180G	72136		1A5A3A6C6	
RS5-75000G	91637	3-17	1A4A5R29		SCDM15C180G	72136		1A4A3A6C7	
RTMT12-2M	91663		1A1E3		SCDM15C180G	72136		1A4A3A6C11	
RTMT12-2M	91663		1A1E4		SCDM15C240G	72136		1A4A3A3C6	
RTMT12-2M	91663		1A1E5		SCDM15C240G	72136		1A4A3A3C7	
NAYS253B	81349	3-37	1A3R49		SCDM15C240G	72136		1A4A3A3C11	
RW29V2R4	81349	3-51	1A9R5		SCM15F181F	72136		1A4A3A3C14	
RW30V8R2	81349	3-34	1A10R1		SCM15F181F	72136		1A4A3A3C17	
RW30V821	81349		1A1R3		SCM15F181F	72136		1A4A3A6C17	
RW31V152	81349	3-38	1A3R5		SCM15F181F	72136	3-8	1A4A3A6C14	
RW31V632	81349	3-38	1A3R16		SCM15F910F	72136		1A4A3A3C12	
RW35V183	81349	3-35	1A12R2		SCM15F910F	72136		1A4A3A3C13	
RW35V183	81349	3-35	1A12R3		SCM15F910F	72136		1A4A3A6C12	
RW35V183	81349	3-35	1A12R4		SCM15F910F	72136	3-8	1A4A3A6C13	
RW59V100	81349	3-17	1A4A5R7		SDA3K01103M	53021	3-12	1A4A2C28	
RW59V100	81349	3-17	1A4A5R8		SDA3K01334K	53021	3-2	1A4C34	
RW67V201	81349	3-49	1A1R2		SDA3K01334K	53021	3-2	1A4C43	
RW69V471	81349	3-38	1A3R40		SDA3K01473M	53021	3-20	1A5A7C37	
RW69V471	81349	3-38	1A3R41		SDA3K01473M	53021	3-20	1A5A7C38	
RW69V471	81349	3-38	1A3R42		SDA3K02682M	53021	3-12	1A4A2C3	
RW69V471	81349	3-38	1A3R43		SDA3K02682M	53021	3-12	1A4A2C9	
RW69V471	81349	3-38	1A3R44		SDA3K02682M	53021	3-12	1A4A2C20	
RW69V471	81349	3-38	1A3R45		SDBIK01103J	53021	3-17	1A4A5C22	
RW69V471	81349	3-38	1A3R46		SDBIK01103J	53021	3-17	1A4A5C35	
RW69V471	81349	3-38	1A3R47		SDBIK01103M	53021	3-5	1A4A1C12	
RI342-1-78-1PCT	15909	3-45	1A7A4R201		SDBIK01103M	53021	3-19	1A5A1C3	
RI342-1-78-1PCT	15909	3-45	1A7A4R202		SDBIK01103M	53021	3-19	1A5A1C5	
B842-24	01686	3-29	1A5A3A1R9		SDBIK01103M	53021	3-23	1A5A5C1	
R842-24	01686	3-29	1A5A3A1R10		SDBIK01103M	53021	3-23	1A5A5C6	

SECTION IV INDEX-FEDERAL STOCK NUMBER AND REFERENCE NUMBER CROSS REFERENCE  
TO FIGURE AND ITEM NUMBER OR REFERENCE DESIGNATION (CONTINUED)

FEDERAL STOCK NUMBER	FIGURE NUMBER		ITEM NUMBER OR REF. DESIGNATION		FEDERAL STOCK NUMBER	FIGURE NUMBER		ITEM NUMBER OR REF. DESIGNATION	
	REFERENCE NO.	MFG. CODE	FIG. NO.	REFERENCE DESIGNATION		REFERENCE NO.	MFG. CODE	FIG. NO.	REFERENCE DESIGNATION
SDB1K01103M	53021	3-23	1A5A5C12		SDB1K03472J	53021	3-17	1A4A5C35	
SDB1K01103M	53021	3-23	1A5A5C18		SDB1K06102M	53021	3-24	1A5A5C15	
SDB1K01103M	53021	3-25	1A5A4C1		SDB1K06102M	53021	3-26	1A5A4C15	
SDB1K01103M	53021	3-25	1A5A4C6		SDB1K06222M	53021	3-5	1A4A1C1	
SDB1K01103M	53021	3-25	1A5A4C12		SDB1K06222M	53021	3-5	1A4A1C6	
SDB1K01103M	53021	3-25	1A5A4C18		SKT1	98291	3-6	1A4A3E30	
SDB1K01103M	53021	3-31	1A5A6C4		SKT1	98291	3-14	1A4A4E22	
SDB1K01103M	53021	3-31	1A5A6C27		SKT1	98291	3-47	1A8J3	
SDB1K01104M	53021	3-5	1A4A1C13		SKT10BLU	98291	3-36	1A3J5	
SDB1K01104M	53021	3-5	1A4A1C14		SKT10WHT	98291	3-6	1A4A3J2	
SDB1K01104M	53021	3-5	1A4A1C15		SKT10WHT	98291	3-36	1A3J4	
SDB1K01104M	53021	3-19	1A5A1C7		SKT2BC	98291	3-5	1A4A1J1	
SDB1K01153M	53021	3-5	1A4A1C7		SKT2BC	98291	3-5	1A4A1J2	
SDB1K01153M	53021	3-12	1A4A2C7		SKT2BC	98291	3-5	1A4A1J3	
SDB1K01473J	53021	3-17	1A4A5C2		SKT2BC	98291	3-19	1A5A1J1	
SDB1K01473M	53021	3-28	1A5A2C6		SKT2BC	98291	3-19	1A5A1J2	
SDB1K01473M	53021	3-27	1A5A2C7		SKT2BC	98291	3-29	1A5A3A1J1	
SDB1K01822K	53021	3-17	1A4A5C37		SKT2BC	98291	3-29	1A5A3A1J2	
SDB1K02104M	53021	3-19	1A5A1C8		SKT2BC	98291	3-30	1A5A3A2J1	
SDB1K02333M	53021	3-12	1A4A2C2		SKT2BC	98291	3-30	1A5A3A2J2	
SDB1K02333M	53021	3-19	1A5A1C9		SKT4IWHT	98291	3-12	1A4A2J1	
SDB1K02333M	53021	3-27	1A5A2C2		SKT4IWHT	98291	3-23	1A5A5J1	
SDB1K02333M	53021	3-27	1A5A2C14		SKT4IWHT	98291	3-23	1A5A5J2	
SDB1K02333M	53021	3-28	1A5A2C13		SKT4IWHT	98291	3-25	1A5A4J1	
SDB1K02333M	53021	3-28	1A5A2C16		SKT4IWHT	98291	3-25	1A5A4J2	
SDB1K02333M	53021	3-28	1A5A2C17		SKT4IWHT	98291	3-27	1A5A2J1	
SDS1K02474M	53021		1A5A7C36		SKT4IWHT	98291	3-27	1A5A2J2	
SDB1K02562M	53021	3-17	1A4A5C35		SKT4IWHT	98291	3-28	1A5A2J3	
SDB1K02682M	53021	3-17	1A4A5C35		SKT4IWHT	98291	3-31	1A5A6J1	
SDB1K02682M	53021	3-31	1A5A6C16		SKT4IWHT	98291	3-31	1A5A6J2	
SDB1K03154M	53021	3-48	1A8C3		SKT5BCWHT	98291		1A4A4J16	

SECTION IV INDEX-FEDERAL STOCK NUMBER AND REFERENCE NUMBER CROSS REFERENCE  
TO FIGURE AND ITEM NUMBER OR REFERENCE DESIGNATION (CONTINUED)

FEDERAL STOCK NUMBER	FIGURE NUMBER	ITEM NUMBER OR REF. DESIGNATION	FEDERAL STOCK NUMBER	FIGURE NUMBER	ITEM NUMBER OR REF. DESIGNATION
<u>REFERENCE NO.</u>	<u>MFG. CODE</u>	<u>FIG. NO.</u> <u>REFERENCE DESIGNATION</u>	<u>REFERENCE NO.</u>	<u>MFG. CODE</u>	<u>FIG. NO.</u> <u>REFERENCE DESIGNATION</u>
SKT5BCWHT	98291	3-6 1A4A3J3	ST42B	81350	3-36 1A3S3
SKT5BCWHT	98291	3-6 1A4A3J12	ST42D	81350	3-52 1A6S4
SKT5BCWHT	98291	3-6 1A4A3J13	ST42H	81350	3-52 1A6S3
SKT5BCWHT	98291	3-9 1A4A3A7J1	S290-7540-000	01281	3-12 1A4A2Y1
SKT5BCWHT	98291	3-9 1A4A3A7J2	S290-7541-000	01281	3-12 1A4A2Y3
SKT5BCWHT	98291	3-10 1A4A3A2J1	S290-7542-000	01281	3-12 1A4A2Y2
SKT5BCWHT	98291	3-10 1A4A3A2J2	S290-7543-000	01281	3-12 1A4A2Y4
SKT5BCWHT	98291	3-14 1A4A4J1	S418FCHHP37L02	40920	3-6 1A4A3MP16
SKT5BCWHT	98291	3-14 1A4A4J3	S418FCHHP37L02	40920	3-6 1A4A3MP17
SKT5BCWHT	98291	3-14 1A4A4J5	S418FCHHP37L02	40920	3-6 1A4A3MP18
SKT5BCWHT	98291	3-14 1A4A4J6	S5632FCHHP37L02	40920	3-6 1A4A3MP8
SKT5BCWHT	98291	3-14 1A4A4J7	S5632FCHHP37L02	40920	3-6 1A4A3MP19
SKT5BCWHT	98291	3-14 1A4A4J8	S614FCHHP37L02	40920	3-16 1A4A4MP12
SKT5BCWHT	98291	3-14 1A4A4J9	S614FCHHP37L02	40920	3-16 1A4A4MP13
SKT5BCWHT	98291	3-14 1A4A4J10	S618FCHHP37L02	40920	3-3 1A4MP73
SKT5BCWHT	98291	3-14 1A4A4J11	S618FCHHP37L02	40920	3-3 1A4MP74
SKT5BCWHT	98291	3-14 1A4A4J12	S63657	82068	3-27 1A5A2L1
SKT5BCWHT	98291	3-14 1A4A4J13	S6632FCHHP37L02	40920	3-3 1A4MP5
SKT5BCWHT	98291	3-14 1A4A4J14	S6632FCHHP37L02	40920	3-3 1A4MP6
SKT5BCWHT	98291	3-14 1A4A4J15	S6632FCHHP37L02	40920	3-3 1A4MP26
SKT5BCWHT	98291	3-16 1A4A4J2	S6632FCHHP37L02	40920	3-3 1A4MP40
SKT5BCWHT	98291	3-16 1A4A4J4	S6632FCHHP37L02	40920	3-3 P41
SK620A	06980	3-38 1A3XV3	S6632FCHHP37L02	40920	3-3 1A4MP43
SK620A	06980	3-38 1A3XV4	S6632FCHHP37L02	40920	3-3 1A4MP75
SP5B	80331	3-57 1A2LS1	S6632FCHHP37L02	40920	3-3 1A4MP76
SS77R3XRIE	43334	3-3 1A4MP28	S6632FCHHP37L02	40920	3-3 1A4MP82
SS77R3XRIE	43334	3-3 1A4MP34	TC2501	37942	3-51 1A9C3
SS77R3XRIE	43334	3-6 1A4A3MP27	TS102P01	81349	3-48 1A8XV1
SS77R3XRIE	43334	3-6 1A4A3MP28	TS102P01	81349	3-48 1A8XV2
ST42A	81349	3-21 1A5A7S4	TS3703	95088	3-23 1A5A5T2
ST42B	81349	3-36 1A3S2	TS3703	95088	3-25 1A5A4T2

SECTION IV INDEX-FEDERAL STOCK NUMBER AND REFERENCE NUMBER CROSS REFERENCE  
TO FIGURE AND ITEM NUMBER OR REFERENCE DESIGNATION (CONTINUED)

FEDERAL STOCK NUMBER	FIGURE NUMBER	ITEM NUMBER OR REF. DESIGNATION	FEDERAL STOCK NUMBER	FIGURE NUMBER	ITEM NUMBER OR REF. DESIGNATION
REFERENCE NO.	MFG. CODE	FIG. NO. REFERENCE DESIGNATION	REFERENCE NO.	MFG. CODE	FIG. NO. REFERENCE DESIGNATION
TS3703	95088	3-31 1A5A6T3	UG58AU	80058	3-58 1A2A2J3
TX10	42489	1A2A2MP7	UG58AU	80058	3-58 1A2A2J4
UG1094U	80058	1A1J3	UG274BU	80058	1A13A2CP1
UG1094U	80058	3-2 1A4J10	UG594AU	80058	1A13A2W1P1
UG1094U	80058	3-2 1A4J11	UG594AU	80058	1A13A2W1P2
UG1094U	80058	3-2 1A4J12	UG594AU	80058	3-58 1A2P4
UG1094U	80058	3-2 1A4J13	UG909BU	80058	3-38 1A3J1
UG1094U	80058	3-2 1A4J14	UG909BU	80058	3-49 1A1J1
UG1094U	80058	3-2 1A4J15	UG931U	80058	3-35 1A12J1
UG1094U	80058	3-22 1A5A7J8	UG931U	80058	3-38 1A3J3
UG1094U	80058	3-22 1A5A7J9	UG932U	80058	1A13A2W9P1
UG1094U	80058	3-22 1A5A7J10	UG932AU	80058	1A13A2W9P2
UG1094U	80058	3-43 1A7J7	UP9BJ39	14655	3-34 1A10C1
UG1094U	80058	3-48 1A8J1	UP9BJ39	14655	3-34 1A10C2
UG1094U	80058	3-48 1A8J2	VCJ1065D	73899	1A2A1C1
UG1094U	80058	3-49 1A1J2	VCJ1065D	73899	1A2A1C2
UG1094U	80058	3-51 1A9J2	VCM15C050K	72136	3-37 1A3C8
UG1094U	80058	3-53 1A6J2	VCM15E111G	72136	3-15 1A4A4C11
UG1094U	80058	3-53 1A6J3	VCM15E241K	72136	3-14 1A4A4C171
UG21EU	80058	1A14P1	VCM15E271G	72136	3-38 1A3C17
UG21EU	80058	1A14P2	VCM15E331G	72136	3-38 1A3C19
UG21EU	80058	1A2P5	VCM15E470J	72136	3-38 1A3C16
UG21EU	80058	3-58 1A2P3	VC42G	73899	3-27 1A5A2C5
UG57BU	81349	1A2J9	VC9GY	73899	3-12 1A4A2C21
UG58AU	80058	3-38 1A3J2	W8309	80223	3-17 1A4A5T2
UG58AU	80058	3-56 1A14J1	X061-1	81815	3-9 1A4A3A7T1
UG58AU	80058	3-58 1A2J1	X062-1	81815	3-9 1A4A3A7L1
UG58AU	80058	3-58 1A2J2	X062-1	81815	3-10 1A4A3A2L4
UG58AU	80058	3-58 1A2J9	X064-1	81815	3-6 1A4A3L3
UG58AU	80058	3-58 1A2J10	X065-1	81815	3-9 1A4A3A7T1
UG58AU	80058	3-58 1A2J11	X066	81815	3-9 1A4A3A7L2

SECTION IV INDEX-FEDERAL STOCK NUMBER AND REFERENCE NUMBER CROSS REFERENCE  
TO FIGURE AND ITEM NUMBER OR REFERENCE DESIGNATION (CONTINUED)

FEDERAL STOCK NUMBER	FIGURE NUMBER		ITEM NUMBER OR REF. DESIGNATION	FEDERAL STOCK NUMBER	FIGURE NUMBER		ITEM NUMBER OR REF. DESIGNATION
	REFERENCE NO.	MFG. CODE	FIG. NO. REFERENCE DESIGNATION		REFERENCE NO.	MFG. CODE	FIG. NO. REFERENCE DESIGNATION
X066	81815	3-10	1A4A3A2L3	1N1095	07688	3-35	1A12CR1
X068-1	81815	3-8	1A4A3A6T1	1N1095	07688	3-35	1A12CR2
X069-1	81815	3-19	1A5A1T1	1N1095	07688	3-35	1A12CR3
X070-1	81815	3-19	1A5A1T2	1N1095	07688	3-35	1A12CR4
X071-1	81815	3-23	1A5A5T1	1N1095	07688	3-35	1A12CR5
X071-1	81815	3-25	1A5A4T1	1N1095	07688	3-35	1A12CR6
X071-1	81815	3-25	1A5A4T4	1N1095	07688	3-35	1A12CR7
X071-1	81815	3-31	1A5A6T1	1N1095	07688	3-35	1A12CR8
X071-1	81815	3-31	1A5A6T2	1N1095	07688	3-35	1A12CR9
X072-1	81815	3-23	1A5A5T4	1N1095	07688	3-35	1A12CR10
X072-1	81815	3-31	1A5A6T5	1N1095	07688	3-35	1A12CR11
X074-1	81815	3-23	1A5A5L2	1N1095	07688	3-35	1A12CR12
X074-1	81815	3-25	1A5A4L2	1N1095	07688	3-35	1A12CR13
X075-1	81815	3-10	1A4A3A2T2	1N1095	07688	3-35	1A12CR14
X075-1	81815	3-10	1A4A3A2T3	1N1095	07688	3-35	1A12CR15
X077-1	81815	3-9	1A4A3A7T2	1N1095	07688	3-35	1A12CR16
X092-2	81815		1A4A4T2A	1N1095	07688	3-35	1A12CR17
X093-1	81815		1A4A4T2	1N1095	07688	3-35	1A12CR18
X215-4	81851		1A4A3A3FL2	1N1095	07688	3-35	1A12CR19
015-0681-000	13499	3-3	1A4M2	1N1095	07688	3-35	1A12CP20
02-310	80483	3-5	1A4A1T1	1N1095	07688	3-35	1A12CR21
02-311	80483	3-5	1A4A1T3	1N1095	07688	3-35	1A12CR22
02-312	80483	3-5	1A4A1T2	1N1095	07688	3-35	1A12CR23
0298-000	54753	3-10	1A4A3A2L1	1N1095	07688	3-35	1A12CR24
0298-000	54753	3-10	1A4A3A2L2	1N1095	07688	3-35	1A12CR25
1GA19A1	03497	3-38	1A3S10	1N1095	07688	3-35	1A12CR26
1N1086A	07688	3-34	1A10CR6	1N1095	07688	3-35	1A12CR27
1N1086A	07688	3-34	1A10CR7	1N1095	07688	3-35	1A12CR28
1N1095	07688	3-34	1A10CR1	1N1095	07688	3-35	1A12CR29
1N1095	07688	3-34	1A10CR5	1N1095	07688	3-35	1A12CR30
1N1095	07688	3-34	1A10CR8	1N1095	07688	3-35	1A12CR31

SECTION IV INDEX-FEDERAL STOCK NUMBER AND REFERENCE NUMBER CROSS REFERENCE  
TO FIGURE AND ITEM NUMBER OR REFERENCE DESIGNATION (CONTINUED)

FEDERAL STOCK T e x t REFERENCE NO.	FIGURE NUMBER			ITEM NUMBER OR REF. DESIGNATION			FEDERAL STOCK NUMBER REFERENCE NO.	FIGURE NUMBER			ITEM NUMBER OR REF. DESIGNATION		
	MFG. CODE	FIG. NO.	REFERENCE DESIGNATION	MFG. CODE	FIG. NO.	REFERENCE DESIGNATION		MFG. CODE	FIG. NO.	REFERENCE DESIGNATION			
IN1095	07688	3-35	1A12CR32	IN251	81349	3-6	1A4A3CR1						
IN1095	07688	3-35	1A12CR33	IN251	81349	3-6	1A4A3CR2						
IN1095	07688	3-35	1A12CR34	IN251	81349	3-6	1A4A3CR3						
IN1095	07688	3-35	1A12CR35	IN251	81349	3-6	1A4A3CR4						
IN1095	07688	3-35	1A12CR36	IN251	81349	3-6	1A4A3CR5						
IN1095	07688	3-35	1A12CR37	IN251	81349	3-6	1A4A3CR6						
IN1095	07688	3-35	1A12CR38	IN270	07688		1A4A3A7CR2						
IN1095	07688	3-35	1A12CR39	IN270	07688	3-10	1A4A3A2CR1						
IN1095	07688	3-35	1A12CR40	IN270	07688	3-10	1A4A3A2CR2						
IN1095	07688	3-35	1A12CR41	IN270	07688	3-10	1A4A3A2CR5						
IN1095	07688	3-35	1A12CR42	IN270	07688	3-10	1A4A3A2CR6						
IN1095	07688	3-35	1A12CR43	IN457	07688		1A4A4CR2						
IN1095	07688	3-35	1A12CR44	IN457	07688		1A4A4CR3						
IN1095	07688	3-37	1A3CR1	IN457	07688	3-5	1A4A1CR3						
IN1095	07688	3-51	1A9CR1	IN457	07688	3-5	1A4A1CR4						
IN1095	07688	3-51	1A9CR2	IN457	07688	3-5	1A4A1CR5						
IN1095	07688	3-51	1A9CR3	IN457	07688	3-5	1A4A1CR6						
IN1095	07688	3-51	1A9CR4	IN457	07688	3-5	1A4A1CR7						
IN1361A	07688	3-34	1A10CR9	IN457	07688	3-5	1A4A1CR8						
IN1489	07688	3-53	1A5CR4	IN457	07688	3-9	1A4A3A7CR1						
IN198	07688	3-5	1A4A1CR1	IN457	07688	3-10	1A4A3A2CR3						
IN198	07688	3-6	1A4A3CR7	IN457	07688	3-10	1A4A3A2CR4						
IN198	07688	3-8	1A4A3A6CR1	IN457	07688	3-20	1A5A7CR1						
IN198	07688	3-8	1A4A3A6CR2	IN457	07688	3-20	1A5A7CR4						
IN198	07688	3-8	1A4A3A6CR3	IN457	07688	3-20	1A5A7CR5						
IN198	07688	3-37	1A3CR4	IN457	07688	3-20	1A5A7CR6						
IN198	07688	3-53	1A6CR2	IN457	07688	3-20	1A5A7CR7						
IN198	07688	3-53	1A6CR3	IN457	07688	3-24	1A5A5CR1						
IN198	07688	3-53	1A6CR5	IN457	07688	3-24	1A5A5CR2						
IN198	07688	3-53	1A6CR6	IN457	07688	3-25	1A5A4CR1						
IN198	07688	3-54	1A6A1CR1	IN457	07688	3-26	1A5A4CR2						

SECTION IV INDEX-FEDERAL STOCK NUMBER AND REFERENCE NUMBER CROSS REFERENCE  
TO FIGURE AND ITEM NUMBER REFERENCE DESIGNATION (CONTINUED)

FEDERAL STOCK NUMBER	FIGURE NUMBER	ITEM NUMBER OR REF. DESIGNATION		FEDERAL STOCK NUMBER	FIGURE NUMBER	ITEM NUMBER OR REF. DESIGNATION	
REFERENCE NO.	MFG. CODE	FIG. NO.	REFERENCE DESIGNATION	REFERENCE NO.	MFG. CODE	FIG. NO.	REFERENCE DESIGNATION
1N457	07688	3-28	1A5A2CR1	116-260	74970	3-3	1A402
1N457	07688	3-31	1A5A6CR2	118P10402S3	56289	3-10	1A4A3A2C18
1N457	07688	3-32	1A5A6CR1	118P10402S3	56289	3-23	1A5A5C3
1N457	07688	3-32	1A5A6CR3	118P10402S3	56289	3-23	1A5A5C9
1N457	07688	3-37	1A3CR6	118P10402S3	56289	3-23	1A5A5C13
1N458	07688	3-20	1A5A7CR2	118P10402S3	56289	3-23	1A5A5C26
1N458	07688	3-20	1A5A7CR3	118P10402S3	56289	3-23	1A5A5C29
1N459	07688	3-37	1A3CR2	118P10402S3	56289	3-25	1A5A4C3
1N459	07688	3-37	1A3CR3	118P10402S3	56289	3-25	1A5A4C9
1N459	07688	3-37	1A3CR5	118P10402S3	56289	3-25	1A5A4C13
1N721A	07688	3-17	1A4A5CR3	118P10402S3	56289	3-25	1A5A4C26
1N816	07688	3-11	1A4A3A8CR1	118P10402S3	56289	3-25	1A5A4C29
1N816	07688	3-11	1A4A3A8CR2	118P10402S3	56289	3-31	1A5A6C2
1N82AG	81349		1A2A1CR1	118P10402S3	56289	3-31	1A5A6C8
1N82AG	81349		1A2A1CR2	118P10402S3	56289	3-31	1A5A6C11
1N91	07688		1A4A5CR2	118P10402S3	56289	3-31	1A5A6C21
1N91	07688	3-17	1A4A5C11	118P10402S3	56289	3-31	1A5A6C23
100W200X1CS	81030	3-3	1A4M1	118P10402S3	56289	3-31	1A5A6C26
10205-3	82142		1A2A1L1	118P33302S3	56289	3-9	1A4A3A7C6
10205-3	82142		1A2A1L2	118P33302S3	56289	3-9	1A4A3A7C8
10205-3	82142	3-38	1A3L5	118P33302S3	56289	3-9	1A4A3A7C9
10205-3	82142	3-38	1A3L6	118P33302S3	56289	3-9	1A4A3A7C11
10205-3	82142	3-38	1A3L7	118P33302S3	56289	3-9	1A4A3A7C13
11F-93550	78277	3-38	1A3K3	118P33302S3	56289	3-9	1A4A3A7C16
11F-93550	78277	3-43	1A7K1	118P33302S3	56289	3-10	1A4A3A2C14
11F-93550	78277	3-53	1A6K1	118P33302S3	56289	3-10	1A4A3A2C15
11SM3T	91929	3-35	1A12S1	118P33302S3	56289	3-10	1A4A3A2C17
112D506C7050J1	56289	3-17	1A4A5C21	118P33302S3	56289	3-10	1A4A3A2C19
1120HBL	81030	3-21	1A5A7M1	118P33302S3	56289	3-10	1A4A3A2C22
1120HBL00IDCMA	81030	3-36	1A3M1	118P33302S3	56289	3-23	1A5A5C4
116-217	74970	3-3	1A401	118P33302S3	56289	3-23	1A5A5C10



SECTION IV INDEX-FEDERAL STOCK NUMBER AND REFERENCE CROSS REFERENCE  
TO FIGURE AND ITEM NUMBER OR REFERENCE DESIGNATION

FEDERAL STOCK NUMBER	FIGURE			ITEM NUMBER OR REF. DESIGNATION			FEDERAL STOCK NUMBER	FIGURE			ITEM NUMBER OR REF. DESIGNATION		
	REFERENCE NO.	MFG. CODE	FIG. NO.	REFERENCE DESIGNATION	REFERENCE NO.	MFG. CODE		FIG. NO.	REFERENCE DESIGNATION	REFERENCE NO.	MFG. CODE	FIG. NO.	REFERENCE DESIGNATION
118P33302S3	56289	3-24	1A5A5C28		143-010-01	02660	3-20	1A5A7J4					
118P33302S3	56289	3-25	1A5A4C4		143-010-01	02660	3-20	1A5A7J6					
118P33302S3	56289	3-25	1A5A4C10		143-010-01	02660	3-20	1A5A7J7					
118P33302S3	56289	3-26	1A5A4C28		1450WBLK	72512		1A5A7O4					
118P33302S3	56289	3-31	1A5A6C3		1450WBLK	72512		1A5A7O5					
118P33302S3	56289	3-31	1A5A6C9		1450WBLK	72512		1A7C2					
118P33302S3	56289	3-31	1A5A6C12		1450WBLK	72512	3-47	1A8O2					
118P33302S3	56289	3-31	1A5A6C25		1450WBLK	72512	3-47	1A8O3					
118P33302S4	56289	3-24	1A5A5C17		1450WBLK	72512	3-52	1A6O4					
118P33302S4	56289	3-26	1A5A4C17		150D105X0035A2	56289	3-54	1A6A1C4					
118P68402S4	56289	3-10	1A4A3A2C28		150D106X0020B2	56289	3-9	1A4A3A7C7					
12AT7	49671	3-53	1A6V1		150D106X0020B2	56289	3-9	1A4A3A7C12					
12AU7	49671	3-53	1A6V2		150D106X0020B2	56289	3-9	1A4A3A7C15					
12103	80089	3-22	1A12L2		150D106X0020B2	56289	3-10	1A4A3A2C8					
122044	75915		1A7A4E201		150D106X0020B2	56289	3-10	1A4A3A2C10					
126-1082	02660	3-6	1A4A3J7		150D187X0006B2	56289	3-10	1A4A3A2C12					
132D106C5025U0	56289	3-40	1A7A1C101		150D224X0035A2	56289	3-8	1A4A3A6C7					
132D206X9010U4	56289	3-40	1A7A1C103		150D224X0035A2	56289	3-8	1A4A3A6C13					
14-234973	82386	3-57	1A2M1		150D224X0035A2	56289	3-23	1A5A5C23					
1400XBLK	72512		1A7O1		150D224X0035A2	56289	3-25	1A5A4C23					
1400XBLK	72512	3-47	1A8O1		150D225X0020A2	56289	3-23	1A5A5C24					
1410223-000	13499		1A5A4E1		150D225X0020A2	56289	3-25	1A5A4C24					
141-0223-000	13499		1A5A5E1		150D225X0035B2	56289	3-8	1A4A3A6C4					
141-0223-000	13499	3-31	1A5A6E1		150D475X0035B2	56289		1A5A6C29					
143-010-01	02660	3-2	1A4J3		150D475XD035B2	56289	3-6	1A4A3C40					
143-010-01	96906	3-2	1A4J4		150D606X0006B2	56289	3-24	1A5A5C21					
143-010-01	02660	3-2	1A4J5		150D606X0006B2	56289	3-24	1A5A5C22					
143-010-01	02660	3-2	1A4J6		150D606X0006B2	56289	3-26	1A5A4C21					
143-010-01	02660	3-20	1A5A7J3		150D6060006B2	56289	3-26	1A5A4C22					
					150D606X0006B2	56289	3-32	1A5A6C18					
					150D606X0006B2	56289	3-32	1A5A6C19					

SECTION IV INDEX-FEDERAL STOCK NUMBER AND REFERENCE NUMBER CROSS REFERENCE  
TO FIGURE AND ITEM NUMBER OR REFERENCE DESIGNATION (CONTINUED)

FEDERAL STOCK NUMBER	FIGURE NUMBER		ITEM NUMBER OR REF. DESIGNATION	FEDERAL STOCK NUMBER	FIGURE NUMBER		ITEM NUMBER OR REF. DESIGNATION
	MFG. CODE	FIG. NO.			MFG. CODE	FIG. NO.	
REFERENCE NO.	MFG. CODE	FIG. NO.	REFERENCE DESIGNATION	REFERENCE NO.	MFG. CODE	FIG. NO.	REFERENCE DESIGNATION
1537-92	99800		1A2A1L1	183-1127-000	13499	3-40	1A7A1C104
1537-92	99800		1A2A1L2	183-1127-000	13499	3-41	1A7A1C102
1537-92	99800	3-38	1A3L5	18-1127-000	13499	3-45	1A7A4C201
1537-92	99800	3-38	1A3L6	183-1601-000	00656	3-37	1A3C54
1537-92	99800	3-38	1A3L7	183-1601-000	00656	3-37	1A3C55
16842	80089	3-51	1A9T1	185146F1	76854	3-26	1A3S1
18-1117	09250	3-2	1A4L3	185147F2C	76854	3-38	1A3S4
18-1117	09250	3-2	1A4L5	185924F3	76854	3-43	1A7S1
18-1117	09250	3-2	1A4L8	185924F3	76854	3-47	1A8S1
18-1117	09250	3-2	1A4L11	186P10301S3	56289	3-10	1A4A3A2G1
18-1117	09250	3-38	1A3L3	186P10301S3	56289	3-29	1A5A3A1G1
18-119	09250		1A4A5L7	186P10301S3	56289	3-29	1A5A3A1G2
18-119	09250	3-6	1A4A3L1	186P10301S3	56289	3-30	1A5A3A2G1
18-119	09250	3-6	1A4A3L6	186P10301S3	56289	3-30	1A5A3A2G2
18-124	09250		1A4A4L33	186P10401T15	56289	3-6	1A4A3C26
18-124	09250	3-5	1A4A1L1	186P10402S15	56289	3-6	1A4A3C21
18-124	09250	3-14	1A4A4L32	186P10402S15	56289	3-6	1A4A3C23
18-124	09250	3-17	1A4A5L6	186P10402S15	56289	3-6	1A4A3C28
18-124	09250	3-29	1A5A3A1L1	186P10402S15	56289	3-6	1A4A3C31
18-124	09250	3-29	1A5A3A1L2	186P10404S15	56289	3-15	1A4A4C75
18-124	09250	3-30	1A5A3A2L1	186P10404S15	56289	3-15	1A4A4C76
18-124	09250	3-30	1A5A3A2L2	186P10491S15	56289	3-53	1A6C3
18-180	09250	3-19	1A5A1L1	186P15391S3	56289	3-6	1A4A3C2
18-180	09250	3-19	1A5A1L2	186P15391S3	56289	3-6	1A4A3C39
18-180	09250	3-27	1A5A2L5	186P15391S3	56289	3-23	1A5A5C2
18-180	09250	3-28	1A5A2L6	185P5391S3	56289	3-23	1A5A5C7
18-184	09250	3-12	1A4A2L1	186P15391S3	56289	3-25	1A5A4C2
18-184	09250	3-12	1A4A2L3	186P15391S3	56289	3-31	1A5A6C1
18-184	09250	3-27	1A5A2L3	186P15391S3	56289	3-31	1A5A6C7
18-273	09250	3-28	1A5A2L2	186P47203S3	56289	3-8	1A4A3A6C1
182645K1	76854	3-21	1A5A7S1	186P47403T15	56289	3-53	1A6C27

SECTION IV INDEX-FEDERAL STOCK NUMBER CROSS REFERENCE  
TO FIGURE AND ITEM NUMBER OR REFERENCE DESIGNATION (CONTINUED)

FEDERAL STOCK NUMBER	FIGURE NUMBER	ITEM NUMBER OR REF. DESIGNATION		FEDERAL STOCK NUMBER	FIGURE NUMBER	ITEM NUMBER OR REF. DESIGNATION	
<u>REFERENCE NO.</u>	<u>MFG. CODE</u>	<u>FIG. NO.</u>	<u>REFERENCE DESIGNATION</u>	<u>REFERENCE NO.</u>	<u>MFG. CODE</u>	<u>FIG. NO.</u>	<u>REFERENCE DESIGNATION</u>
186P68302S3	56289	3-8	1A4A3A6C14	2B10B12	92825	3-2	1A4E8
19C11A2	56289	3-10	1A4A3A2C26	2B10B12	92825	3-2	1A4E9
19C11A2	56289	3-10	1A4A3A2C27	2B10B12	92825	3-2	1A4E10
19C28A1	56289		1A4A3A2C35	2B10B12	92825	3-2	1A4E11
19C28A1	56289		1A4A3A2C36	2B10B12	92825	3-42	1A7E1
19C388	56289		1A4A3A2C35	2B10B12	92825	3-42	1A7E2
19C388	56289		1A4A3A2C36	2B10B12	92825	3-42	1A7E3
195388DHC	76854	3-57	1A2A2S1	2K40F22KPORM10PCT	44655	3-35	1A12R1
195389DHC	76854	3-57	1A2A2S2	2N1150	07688	3-12	1A4A2Q1
195670K1	76854	3-21	1A5A7S2	2N1150	07688	3-12	1A4A2Q2
19582F1	76854	3-53	1A6S2	2N1150	07688	3-24	1A5A5Q1
195983F4	76854	3-53	1A6S1	2N1150	07688	3-26	1A5A4Q1
196P105625P	56289	3-53	1A6C2	2N150	07688	3-32	1A5A6Q1
197467DHC	76854	3-57	1A2S3B	2N117	07688	3-5	1A4A1Q1
197468DH	76854	3-57	1A2S3A	2N117	07688	3-5	1A4A1Q2
2A1DB12	92825		1A5A7E4	2N117	07688	3-5	1A4A1Q3
2A1DB12	92825		1A5A7E5	2N117	07688	3-5	1A4A1Q4
2A1DB12	92825		1A5A7E6	2N117	07688	3-5	1A4A1Q5
2A1DB12	92825		1A5A7E7	2N117	07688	3-5	1A4A1Q6
2A1DB12	92825		1A5A7E8	2N117	07688	3-5	1A4A1Q7
2A1DB12	92825		1A5A7E9	2N158A	07688	3-40	1A7A1Q102
2A1DB12	92825		1A5A7E10	2N158A	07688	3-45	1A7A4Q201
2A1DB12	92825		1A8E15	2N158A	07688	3-45	1A7A4Q202
2A1DB12	92825	3-2	1A4E13	2N243	07688	3-24	1A5A5Q2
2A1DB12	92825	3-2	1A4E14	2N243	07688	3-24	1A5A5Q3
2B10B12	92825		1A8E10	2N243	07688	3-26	1A5A4Q2
2B10B12	92825		1A8E14	2N243	07688	3-26	1A5A4Q3
2B10B12	92825		1A8E16	2N243	07688	3-32	1A5A6Q2
2B10B12	92825	3-2	1A4E5	2N243	07688	3-32	1A5A6Q3
2B10B12	92825	3-2	1A4E6	2N264	07688	3-8	1A4A3A6Q1
2B10B12	92825	3-2	1A4E7	2N264	07688	3-8	1A4A3A6Q2

TM 11-5820-555-24P  
SECTION IV INDEX-FEDERAL STOCK NUMBER AND REFERENCE NUMBER CROSS REFERENCE  
TO FIGURE AND ITEM NUMBER OR REFERENCE DESIGNATION (CONTINUED)

FEDERAL STOCK NUMBER	FIGURE NUMBER		ITEM NUMBER OR REF. DESIGNATION	FEDERAL STOCK NUMBER	FIGURE NUMBER		ITEM NUMBER OR REF. DESIGNATION
	MFPG. CODE	FIG. NO.	REFERENCE DESIGNATION		MFPG. CODE	FIG. NO.	REFERENCE DESIGNATION
2N264	07688	3-8	1A4A3A6Q3	22H5Q12CJ	14655		1A4A4C88
2N264	07688	3-9	1A4A3A7Q1	22H5Q12CJ	14655	3-15	1A4A4C46
2N264	07688	3-9	1A4A3A7Q2	22H5Q15CJ	14655	3-6	1A4A3C11
2N264	07688	3-9	1A4A3A7Q3	22H5Q22CJ	14655		1A4A4C185
2N264	07688	3-10	1A4A3A2Q3	22H5Q22CJ	14655	3-12	1A4A2C16
2N264	07688	3-10	1A4A3A2Q4	22H5Q22CJ	14655	3-15	1A4A4C13
2N264	07688	3-10	1A4A3A2Q5	22H5Q22CJ	14655	3-15	1A4A4C94
2N264	07688	3-10	1A4A3A2Q6	22H5Q22CJ	14655	3-6	1A4A3C33
2N264	07688	3-17	1A4A5Q13	22H5Q22CJ	14655	3-6	1A4A3C6
2N274	07688	3-54	1A6A1Q1	22H5Q22CJ	14655	3-15	1A4A4C48
2N44	07688	3-40	1A7A1Q101	22H5Q3DG	14655		1A4A4C40
2N499	07688	3-17	1A4A5Q5	22H5Q3DG	14655	3-17	1A4A5C24
2N499	07688	3-17	1A4A5Q6	22H5Q33DG	14655		1A4A4C59
2N499	07688	3-17	1A4A5Q7	22H5Q33DG	14655		1A4A4C186
2N499	07688	3-17	1A4A5Q8	22H5Q33DG	14655	3-10	1A4A3A2C32
2N499	07688	3-17	1A4A5Q9	22H5Q33DJ	14655	3-10	1A4A3A2C33
2N499	07688	3-17	1A4A5Q10	22H5Q33DG	14655	3-12	1A4A2C1
2N499	07688	3-17	1A4A5Q11	22H5Q33DG	14655		1A4A4C148
2N499	07688	3-17	1A4A5Q12	22H5Q36DG	14655	3-15	1A4A4C93
2N527	07688	3-17	1A4A5Q3	22H5Q39DJ	14655	3-6	1A4A3C15
2N540	07688	3-17	1A4A5Q1	22H5Q39DJ	14655	3-28	1A5A2C8
2N540	07688	3-17	1A4A5Q2	22H5Q43DJ	14655		1A4A4C33
2N540	07688	3-17	1A4A5Q4	22H5Q43DJ	14655	3-15	1A4A4C12
20C109	01939		1A4A3C43	22H5Q47DJ	14655	3-17	1A4A5C31
20C109	01939	3-10	1A4A3A2C2	22H5Q51EG	14655		1A4A4C85
20C109	01939	3-10	1A4A3A2C7	22H5Q51EG	14655	3-6	1A4A3C46
105428H1	76854	3-57	1A2S1	22H5Q51EJ	14655	3-6	1A4A3C27
21603	80089	3-40	1A7A1T102	22H5Q56EG	14655		1A4A4C28
22H5Q1CJ	14655	3-6	1A4A3C14	22H5Q56EG	14655	3-12	1A4A2C26
22H5Q1CJ	14655	3-12	1A4A2C24	22H5Q56EJ	14655	3-12	1A4A2C13
22H5Q1CJ	14655	3-15	1A4A4C62	22H5Q62EG	14655	3-12	1A4A2C26

SECTION IV INDEX-FEDERAL STOCK NUMBER AND REFERENCE NUMBER CROSS REFERENCE  
TO FIGURE AND ITEM NUMBER OR REFERENCE DESIGNATION (CONTINUED)

FEDERAL STOCK NUMBER	FIGURE NUMBER	ITEM NUMBER OR REF. DESIGNATION	FEDERAL STOCK NUMBER	FIGURE NUMBER	ITEM NUMBER OR REF. DESIGNATION
REFERENCE NO.	MFG. CODE	FIG. NO. REFERENCE DESIGNATION	REFERENCE NO.	MFG. CODE	FIG. NO. REFERENCE DESIGNATION
22H5Q68EG	14655	1A4A4C64	22H5TU13EG	14655	3-17 1A4A5C9
22H5Q68EG	14655	3-6 1A4A3C8	22H5TU13EG	14655	3-29 1A5A3A1C5
22H5Q68EG	14655	3-12 1A4A2C22	22H5TU13EG	14655	3-30 1A5A3A2C5
22H5Q75EG	14655	1A4A4C68	22H5TU15EG	14655	1A4A4C6
22H5Q75EG	14655	1A4A4C81	22H5TU15EG	14655	1A4A4C18
22H5Q82EG	14655	3-6 1A4A3C4	22H5TU15EG	14655	1A4A4C49
22H5Q82EG	14655	3-6 1A4A3C40	22H5TU15EG	14655	1A4A4C78
22H5Q82EG	14655	3-9 1A4A3A7C1	22H5TU15EJ	14655	3-12 1A4A2C25
22H5Q91EG	14655	3-29 1A5A3A1C5	22H5TU15EJ	14655	3-27 1A5A2C11
22H5Q91EG	14655	3-30 1A5A3A2C5	22H5TU15EJ	14655	3-27 1A5A2C12
22H5T1EG	14655	3-7 1A4A3A3C10	22H5TU16EJ	14655	3-10 1A4A3A2C9
22H5T1EG	14655	3-17 1A4A5C6	22H5TU18EG	14655	1A4A4C131
22H5T1EG	14655	3-17 1A4A5C8	22H5TU18EG	14655	3-6 1A4A3C42
22H5T1EG	14655	3-17 1A4A5C12	22H5TU18EG	14655	3-6 1A4A3C44
22H5T1EG	14655	3-17 1A4A5C25	22H5TU18EG	14655	3-9 1A4A3A7C2
22H5T1EG	14655	3-17 1A4A5C33	22H5TU18EG	14655	3-23 1A5A5C5
22H5T1EG	14655	3-29 1A5A3A1C5	22H5TU18EG	14655	3-25 1A5A4C5
22H5T1EG	14655	3-30 1A5A3A2C5	22H5TU18EG	14655	3-29 1A5A3A1C3
22H5T1EJ	14655	3-28 1A5A2C15	22H5TU18EG	14655	3-29 1A5A3A1C4
22H5T11EG	14655	3-29 1A5A3A1C5	22H5TU18EG	14655	3-30 1A5A3A2C3
22H5T11EG	14655	3-30 1A5A3A2C5	22H5TU18EG	14655	3-30 1A5A3A2C4
22H5T11EJ	14655	3-12 1A4A2C4	22H5TU18EG	14655	3-31 1A5A6C5
22H5T11EJ	14655	3-12 1A4A2C18	22H5T2EG	14655	3-7 1A4A3A3C11
22H5T12EG	14655	3-29 1A5A3A1C5	22H5T2EG	14655	3-9 1A4A3A7C5
22H5T12EG	14655	3-30 1A5A3A2C5	22H5T2EG	14655	3-9 1A4A3A7C10
22H5T13EG	14655	1A4A4C2	22H5T2EG	14655	3-9 1A4A3A7C14
22H5T13EG	14655	1A4A4C9	22H5T2EG	14655	3-10 1A4A3A2C13
22H5T13EG	14655	1A4A4C14	22H5T2EG	14655	3-10 1A4A3A2C16
22H5T13EG	14655	1A4A4C73	22H5T2EG	14655	3-10 1A4A3A2C20
22H5T13EG	14655	3-15 1A4A4C121	22H5T2EG	14655	3-17 1A4A5C15
22H5T13EG	14655	3-15 1A4A4C180	22H5T2EG	14655	3-29 1A5A3A1C3

SECTION IV INDEX-FEDERAL STOCK NUMBER AND REFERENCE NUMBER CROSS REFERENCE  
TO FIGURE AND ITEM NUMBER OR REFERENCE DESIGNATION

FEDERAL STOCK NUMBER	FIGURE NUMBER		ITEM NUMBER OR REF. DESIGNATION		FEDERAL STOCK NUMBER	FIGURE NUMBER		ITEM NUMBER OR REF. DESIGNATION	
	REFERENCE NO.	MFG. CODE	FIG. NO.	REFERENCE DESIGNATION		REFERENCE NO.	MFG. CODE	FIG. NO.	REFERENCE DESIGNATION
22H5T2EG	14655		3-29	1A5A3A1C4	22H5T33EG	14655	3-32	1A5A6C22	
22H5T2EG	14655		3-30	1A5A3A2C3	22H5T33EG	14655	3-8	1A4A3A6C3	
22H5T2EG	14655		3-30	1A5A3A2C4	22H5T36EG	14655		1A4A4C79	
22H5T2EJ	14655		3-12	1A4A2C17	22H5T36EG	14655		1A4A4C83	
22H5T2EJ	14655		3-12	1A4A2C27	22H5T36EG	14655	3-17	1A4A5C38	
22H5T24EG	14655			1A5A3A1C3	22H5T39EG	14655	3-15	1A4A4C178	
22H5T24EG	14655			1A5A3A1C4	22H5T39EG	14655	3-17	1A4A5C38	
22H5T24EG	14655			1A5A3A2C3	22H5T43EG	14655		1A4A4C86	
22H5T24EG	14655			1A5A3A2C4	22H5T43EG	14655	3-7	1A4A3A3C8	
22H5T24EG	14655	3-19		1A5A1C1	22H5T43EG	14655	3-8	1A4A3A6C6	
22H5T24EJ	14655		3-10	1A4A3A2C34	22H5T43EG	14655	3-17	1A4A5C38	
22H5T27EG	14655			1A4A3A6C8	22H5T47EG	14655		1A4A4C82	
22H5T27EG	14655			1A4A3A6C9	22H5T47EG	14655		1A4A5C38	
22H5T27EG	14655	3-8		1A4A3A6C5	22H5T47EG	14655	3-6	1A4A3C24	
22H5T27EG	14655	3-19		1A5A1C10	22H5T47EG	14655	3-6	1A4A3C25	
22H5T27EG	14655	3-29		1A5A3A1C3	22H5T51EG	14655		1A4A4C53	
22H5T27EG	14655	3-29		1A5A3A1C4	22H5T51EG	14655	3-6	1A4A3C20	
22H5T27EG	14655	3-30		1A5A3A2C3	22H5T51EG	14655	3-8	1A4A3A6C13	
22H5T27EG	14655	3-30		1A5A3A2C4	22H5T51EG	14655	3-9	1A4A3A7C3	
22H5T3EG	14655	3-15		1A4A4C26	22H5T51EG	14655	3-17	1A4A5C38	
22H5T3EG	14655	3-17		1A4A5C38	22H5T51EG	14655	3-19	1A5A1C2	
22H5T3EG	14655	3-24		1A5A5C27	22H5T51EG	14655	3-23	1A5A5C14	
22H5T3EG	14655	3-26		1A5A4C27	22H5T51EG	14655	3-24	1A5A5C11	
22H5T3EG	14055	3-32		1A5A6C24	22H5T51EG	14655	3-26	1A5A4C11	
22H5T33EG	14655			1A4A4C118	22H5T51EG	14655	3-26	1A5A4C14	
22H5T33EG	14655			1A4A4C119	22H5T51EG	14655	3-32	1A5A6C10	
22H5T33EG	14655	3-15		1A4A4C177	22H5T51EG	14655	3-32	1A5A6C13	
22H5T33EG	14655	3-17		1A4A5C38	22H5T51EG	14655	3-10	1A4A3A2C31	
22H5T33EG	14655	3-24		1A5A5C25	22H5T51EJ	14655	3-12	1A4A2C32	
22H5T33EG	14655	3-26		1A5A4C25	22H5T51EJ	14655	3-27	1A5A2C1	
22H5T33EG	14655	3-32		1A5A6C14	22H5T51EJ	14655	3-28	1A5A2C9	

SECTION IV INDEX-FEDERAL STOCK NUMBER AND REFERENCE NUMBER CROSS REFERENCE  
 TO FIGURE AND ITEM NUMBER OR REFERENCE DESIGNATION (CONTINUED)

FEDERAL STOCK NUMBER	FIGURE NUMBER		ITEM NUMBER OR REF. DESIGNATION		FEDERAL STOCK NUMBER	FIGURE NUMBER		ITEM NUMBER OR REF. DESIGNATION	
	REFERENCE NO.	MFG. CODE	FIG. NO.	REFERENCE DESIGNATION		REFERENCE NO.	MFG. CODE	FIG. NO.	REFERENCE DESIGNATION
22H5722EG	14655			1A4A4C56	25763	73386	3-42	1A7T1	
22H5722EG	14655			1A4A4C89	25763	73386	3-42	1A7T4	
22H5722EG	14655	3-29		1A4A3A1C3	25763	73386	3-42	1A7T5	
22H5722EG	14655	3-29		1A5A3A1C4	25763	73386	3-47	1A8T1	
22H5722EG	14655	3-30		1A5A3A2C3	259-0886-000	13499	3-51	1A9S1	
22H5722EC	14655	3-30		1A5A3A2C4	26-4401-16S	02660	3-2	1A4J17	
220-1248-000	13499	3-41		1A7A1XQ101	26-4401-16S	02660	3-43	1A7J8	
224L1-203	80249	3-11		1A4A3A8R1	26-4401-24S	02660	3-53	1A6J1	
228730BF1	76854	3-38		1A3S11	26-4401-7705	02660	3-38	1A3J6	
228730BF1	76854	3-38		1A3S12	26-4401-6S	02660	3-46	1A11J1	
229-201-3	74970	3-57		1A2A2L1	26-4402-16S	02660	3-22	1A5A7J12	
229-201-3	74970	3-37		1A3L4	26-4402-16S	02660	3-34	1A10J1	
229-202-4	74970			1A3L16	26-4402-16S	02660	3-51	1A9J3	
240-0272-000	95105	3-2		1A4L1	26-4402-16S	02660	3-58	1A2J8	
240-0272-000	95105	3-2		1A4L17	26-4403-16S	02660	3-2	1A4J16	
240-0287-000	13499	3-53		1A6L1	26-4403-16S	02660	3-43	1A7J9	
240-4287-000	13499	3-53		1A6L2	26-4404-16S	02660	3-22	1A5A7J13	
24544	80089	3-17		1A4A5T3	26-4404-16S	02660	3-34	1A10J2	
24545	80089	3-17		1A4A5T1	26-4405-16S	02660	3-22	1A5A7J11	
25-100GRN	72765			1A6DS4	26-4405-16S	02660	3-48	1A8J4	
25-100RED	72765			1A6DS3	26-4501-16D	02660		1A13A2W11P1	
25-100RED	72765	3-33		1A10DS1	26-4501-16D	02660		1A13A2W17P1	
2500-42	99800	3-2		1A4L3	26-4501-16D	02660		1A13A2W19P1	
2500-42	99800	3-2		1A4L5	26-4501-24P	02660		1A13A2W14P1	
2500-42	99800	3-2		1A4L8	26-4501-8p	02660		1A13A2W26P1	
2500-42	99800	3-2		1A4L11	26-4502-16P	02660		1A13A2W16P1	
2500-42	99800	3-38		1A3L3	26-4502-16P	02660		1A13A2W18P1	
2500-62	99800	3-37		1A3L12	26-4502-16P	02660		1A13A2W22P1	
2500-76	99800	3-6		1A4A3L9	26-4502-16P	02660		1A13A2W24P1	
25390	80089	3-29		1A5A3A1T1	26-4503-16P	02660		1A13A2W13P1	
25390	80089	3-30		1A5A3A2T1	26-4503-16P	02660		1A13A2W20P1	

SECTION IV INDEX-FEDERAL STOCK NUMBER AND REFERENCE NUMBER CROSS REFERENCE  
TO FIGURE AND ITEM NUMBER OR REFERENCE DESIGNATION (CONTINUED)

FEDERAL STOCK NUMBER	FIGURE NUMBER	ITEM NUMBER OR REF. DESIGNATION	FEDERAL STOCK NUMBER	FIGURE NUMBER	ITEM NUMBER OR REF. DESIGNATION
REFERENCE No.	MFG. CODE	FIG. NO. REFERENCE DESIGNATION	REFERENCE NO.	MFG. CODE	FIG. NO. REFERENCE DESIGNATION
26-4504-16P	02660	1A13A2W21P1	2856005X50102P	72982	3-15 1A4A4C133
26-4504-16P	02660	1A13A2W23P1	2856005X50102P	72982	3-15 1A4A4C159
26-4505-16P	02660	1A13A2W12P1	2856005X50102P	72982	3-15 1A4A4C160
26-4505-16P	02660	1A13A2W15P1	2856005X50102P	72982	3-15 1A4A4C161
26582	80089	3-34 1A10L3	2856005X50102P	72982	3-15 1A4A4C162
2691A	12615	3-17 1A4A5E2	2856005X50102P	72982	3-15 1A4A4C163
2691A	12615	3-17 1A4A5E5	2856005X50102P	72982	3-15 1A4A4C164
2691A	12615	3-17 1A4A5E6	2856005X50102P	72982	3-15 1A4A4C165
2691A	12615	3-17 1A4A5E8	2856005X50102P	72982	3-15 1A4A4C166
2691A	12615	3-17 1A4A5E11	2856005X50102P	72982	3-15 1A4A4C167
2691A	12615	3-17 1A4A5E12	2856005X50102P	72982	3-15 1A4A4C168
2691A	12615	3-17 1A4A5E13	2856005X50102P	72982	3-15 1A4A4C169
2691A	12615	3-17 1A4A5E14	2856005X50102P	72982	3-15 1A4A4C172
278-0296-000	54753	3-10 1A4A3A2T1	2856005X50102P	72982	3-15 1A4A4C173
278-0297-000	54753	3-10 1A4A3A2T4	2856005X50102P	72982	3-15 1A4A4C175
27803	73386	3-45 1A7A4T201	288-0030-000	13499	3-13 1A4A4E28
28130	80089	3-42 1A7T7	29c296	56289	3-10 1A4A3A2C26
2856005X5U0102P	72982	1A4A4C103	29C296	56289	3-10 1A4A3A2C27
2856005X50102P	72982	3-15 1A4A4C67	29c296	56289	1A4A3A2C35
2856005X50102P	72982	3-15 1A4A4C90	29c297	56289	1A4A3A2C36
2856005X50102P	72982	3-15 1A4A4C96	29C35A3	56289	1A4A3A2C35
2856005X50102P	72982	3-15 1A4A4C97	29C35A3	56289	1A4A3A2C36
2856005X50102P	72982	3-15 1A4A4C98	29C35A3	56289	1A4A3A2C35
2856005X50102P	72982	3-15 1A4A4C101	29C35A3	56289	1A4A3A2C36
2856005X50102P	72982	3-15 1A4A4C106	290-5430-000	71034	3-17 1A4A5Y1
2856005X50102P	72982	3-15 1A4A4C107	292-5648G1A	49956	3-35 1A12T1
2856005X50102P	72982	3-15 1A4A4C110	292-5660G1	49956	3-35 1A12L1
2856005X50102P	72982	3-15 1A4A4C115	3B2WA	49671	3-47 1A8VI
2856005X50102P	72982	3-15 1A4A4C116	300-11796	74868	3-49 1A1KI
2856005X50102P	72982	3-15 1A4A4C117	3003TEMFLEX-105CLR3-81N	75037	1A13A2H7
2856005X50102P	72982	3-15 1A4A4C123	3010L1-102	80294	1A5A4R33



SECTION IV INDEX-FEDERAL STOCK NUMBER AND REFERENCE NUMBER CROSS REFERENCE  
TO FIGURE AND ITEM NUMBER OR REFERENCE DESIGNATION (CONTINUED)

<u>FEDERAL STOCK NUMBER</u>	<u>FIGURE NUMBER</u>	<u>ITEM NUMBER OR REF. DESIGNATION</u>		<u>FEDERAL STOCK NUMBER</u>	<u>FIGURE NUMBER</u>	<u>ITEM NUMBER OR REF. DESIGNATION</u>	
<u>REFERENCE NO.</u>	<u>MFG. CODE</u>	<u>FIG. NO.</u>	<u>REFERENCE DESIGNATION</u>	<u>REFERENCE NO.</u>	<u>MFG. CODE</u>	<u>FIG. NO.</u>	<u>REFERENCE DESIGNATION</u>
3010L1-102	80294		1A5A5R33	3188002	72982		1A4A4C29
3010L1-102	80294		1A5A6R31	3188002	72982		1A4A4C31
3010L-201	80294	3-29	1A5A3A1R7	3188002	72982		1A4A4C34
3010L1-201	80294	3-29	1A5A3A1R8	3188002	72982		1A4A4C36
3010L1-201	80294	3-30	1A5A3A2R7	3188002	72982		1A4A4C54
3010L1-201	80294	3-30	1A5A3A2R8	3188002	72982		1A4A4C57
30183	04796		1A13A2W16TBF	3188002	72982		1A4A4C69
30183	04796		1A13A2W18TBF	3188002	72982		1A4A4C71
30183	04796		1A13A2W22TBM	3188002	72982		1A4A4C80
30183	04796		1A13A2W22TBP	3188002	72982		1A4A4C84
310-0049-000	79807		1A13A1H3	3188003	72982		1A4A4C3
310-0050-000	79807		1A13H3	3188003	72982		1A4A4C10
3171000COP017R	72982		1A4A4C129	3188003	72982		1A4A4C16
3171000COP039R	72982		1A4A4C138	3188003	72982		1A4A4C24
3172000COP017R	72982	3-6	1A4A3C12	3188003	72982		1A4A4C51
3172000COP039R	72982	3-6	1A4A3C7	3188003	72982		1A4A4C77
31720002P034R	72982		1A4A4C7	3188003	72982		1A4A4C120
3172000U2P034R	72982		1A4A4C19	32D2141T	56289	3-51	1A9C1
3172000U2P034R	72982	3-6	1A4A3C3	32D2141T	56289	3-51	1A9C2
3173000U2P034R	72982		1A4A4C91	32400-0-140	73168	3-17	1A4A5CB1
3173000U2P034R	72982		1A4A4C176	325-0124-000	17264		1A13H4
3188001	72982		1A4A4C39	3260440100	01146	3-46	1A11S1
3188001	72982		1A4A4C41	327-029X5T0102Z	72982		1A2C1
3188001	72982		1A4A4C43	327-029X5T0102Z	72982		1A2C2
3188001	72982		1A4A4C60	327-029X5T0102Z	72982		1A2C3
3188001	72982		1A4A4C87	327-029X5T0102Z	72982		1A2C4
3188001	72982		1A4A4C125	327-029X5T0102z	72982	3-2	1A4C1
3188001	72982		1A4A4C141	327-029X5T0102Z	72982	3-2	1A4C2
3188001	72982		1A4A4C149	327-029X5T0102Z	72982	3-2	1A4C3
3188001	72982	3-6	1A4A3C30	327-029X5T0102Z	72982	3-2	1A4C4
3188001	72982	3-6	1A4A3C36	327-029X5T0102Z	72982	3-2	1A4C5

SECTION IV INDEX-FEDERAL STOCK NUMBER AND REFERENCE NUMBER CROSS REFERENCE  
TO FIGURE AND ITEM NUMBER OR REFERENCE DESIGNATION (CONTINUED)

FEDERAL STOCK NUMBER	FIGURE NUMBER		ITEM NUMBER OR REF. DESIGNATION		FEDERAL STOCK NUMBER	FIGURE NUMBER		ITEM NUMBER OR REF. DESIGNATION	
	REF. NO.	MFG. CODE	FIG. NO.	REFERENCE DESIGNATION		REF. NO.	MFG. CODE	FIG. NO.	REFERENCE DESIGNATION
327-029X5T0102Z		72982	3-2	1A4C6	327-029x5T0102Z	72982	3-20	1A5A7C18	
327-029X5T0102Z		72982	3-2	1A4C7	327-029X5T0102Z	72982	3-20	1A5A7C19	
327-029X5T0102Z		72982	3-2	1A4C8	327-029X5T0102Z	72982	3-20	1A5A7C20	
327-029X5T0102Z		72982	3-2	1A4C9	327-029X5T0102Z	72982	3-20	1A5A7C21	
327-029X5T0102Z		72982	3-2	1A4C10	327-029X5T0102Z	72982	3-20	1A5A7C22	
327-029X5T0102Z		72982	3-2	1A4C11	327-029X5T0102Z	72982	3-20	1A5A7C23	
327-029X5T0102Z		72982	3-2	1A4C12	327-029X5T0102Z	72982	3-20	1A5A7C24	
327-029X5T0102Z		72982	3-2	1A4C13	327-029X5T0102Z	72982	3-20	1A5A7C25	
327-029X5T0102Z		72982	3-2	1A4C14	327-029X5T0102Z	72982	3-20	1A5A7C26	
327-029X5T0102Z		72982	3-2	1A4C15	327-029X5T0102Z	72982	3-20	1A5A7C27	
327-029X5T0102Z		72982	3-2	1A4C16	327-029X5T0102Z	72982	3-20	1A5A7C28	
327-029X5T0102Z		72982	3-2	1A4C17	327-029X5T0102Z	72982	3-20	1A5A7C29	
327-029X5T0102Z		72982	3-2	1A4C18	327-029X5T0102Z	72982	3-20	1A5A7C30	
327-029X5T0102Z		72982	3-2	1A4C19	327-029X5T0102Z	72982	3-20	1A5A7C31	
327-029x5T0102Z		72982	3-20	1A5A7C1	327-029X5T0102Z	72982	3-20	1A5A7C32	
327-029X5T0102Z		72982	3-20	1A5A7C2	327-029X5T0102Z	72982	3-20	1A5A7C33	
327-029X5T0102Z		72982	3-20	1A5A7C3	327-029X5T0102Z	72982	3-20	1A5A7C34	
327-029X5T0102Z		72982	3-20	1A5A7C4	327-029X5T0102Z	72982	3-20	1A5A7C35	
327-029X5T0102Z		72982	3-20	1A5A7C5	327-029X5T0102Z	72982	3-37	1A3C39	
327-029X5T0102Z		72982	3-20	1A5A7C6	327-029X5T0102Z	72982	3-37	1A3C40	
327-029X5T0102Z		72982	3-20	1A5A7C7	327-029X5T0102Z	72982	3-37	1A3C56	
327-029X5T0102Z		72982	3-20	1A5A7C8	327-029X5T0102Z	72982	3-37	1A3C69	
327-029X5T0102Z		72982	3-20	1A5A7C9	327-029X5T0102Z	72982	3-37	1A3C74	
327-029X5T0102Z		72982	3-20	1A5A7C10	327-029X5T0102Z	72982	3-38	1A3C42	
327-029X5T0102Z		72982	3-20	1A5A7C11	327-029X5T0102Z	72982	3-38	1A3C45	
327-029X5T0102Z		72982	3-20	1A5A7C12	327-029X5T0102Z	72982	3-38	1A3C46	
327-029X5T0102Z		72982	3-20	1A5A7C13	327-029X5T0102Z	72982	3-38	1A3C47	
327-029X5T0102Z		72982	3-20	1A5A7C14	327-029X5T0102Z	72982	3-38	1A3C57	
327-029X5T0102Z		72982	3-20	1A5A7C15	327-029X5T0102Z	72982	3-38	1A3C58	
327-029X5T0102Z		72982	3-20	1A5A7C16	327-029X5T0102Z	72982	3-38	1A3C59	
327-029X5T0102Z		72982	3-20	1A5A7C17	327-029X5T0102Z	72982	3-38	1A3C60	

SECTION IV INDEX-FEDERAL STOCK NUMBER AND REFERENCE NUMBER CROSS REFERENCE  
 TO FIGURE AND ITEM NUMBER OR REFERENCE DESIGNATION (CONTINUED)

FEDERAL STOCK NUMBER	FIGURE NUMBER	ITEM NUMBER OR REF DESIGNATION	FEDERAL STOCK NUMBER	FIGURE NUMBER	ITEM NUMBER OR REF. DESIGNATION
<u>REFERENCE NO.</u>	<u>MFG. CODE</u>	<u>FIG. NO.</u> <u>REFERENCE DESIGNATION</u>	<u>REFERENCE NO.</u>	<u>MFG. CODE</u>	<u>FIG. NO.</u> <u>REFERENCE DESIGNATION</u>
327-029X5TO102Z	72982	3-38 1A3C61	338023X2H0620J	72982	1A4A4C52
327-029X5TO102Z	72982	3-38 1A3C62	338023S2H0750J	72982	1A4A4C20
327-029X5TO102Z	72982	3-38 1A3C63	338026C0H360J	72982	1A4A4C22
327-029X5TO102Z	72982	3-38 1A3C64	338026R2H0390G	72982	1A4A4C35
327-029X5TO102Z	72982	3-38 1A3C65	338026R2H0560J	72982	1A4A4C30
327-029X5TO102Z	72982	3-38 1A3C66	348026R2H0680G	72982	1A4A4C137
327-029X5TO102Z	72982	3-38 1A3C67	340166	79515	3-36 1A3XF1
327-029X5TO102Z	72982	3-38 1A3C68	343-2949-002	13499	1A4A4L26
327-029X5TO102Z	72982	3-49 1A1C1	36818-18	80583	3-54 1ACA1C11
327-029X5TO102Z	72982	3-54 1A6A1C1	39016	76487	3-37 1A3MP11
327-029X5TO102Z	72982	3-54 1A6A1C2	3990-200	09922	3-6 1A4A3J4
327-029X5TO102Z	72982	3-54 1A6A1C3	3990-200	09922	3-6 1A4A3J5
33-817	02660	3-12 1A4A2XY1	399L-200	09922	3-6 1A4A3J6
33C2	01939	3-2 1A4C41	3990-200	09922	3-6 1A4A3J8
33C2	01939	3-2 1A4C42	3990-200	09922	3-6 1A4A3J9
33C2	01939	3-2 1A4C44	40-3587	04221	3-51 1A9K1
33C2	01939	3-37 1A3C72	40C157A1	56289	1A4A3A2C35
33C2	01939	3-38 1A3C4	40C157A1	56289	1A4A3A2C36
33C2	01939	3-38 1A3C5	40C78	56289	3-10 1A4A3A2C26
33C2	01939	3-43 1A7C23	40C78	56289	3-10 1A4A3A2C27
33C2	01939	3-48 1A8C4	41-642	06978	3-23 1A5A5L1
33C2	01939	3-53 1A6C1	41-642	06978	3-25 1A5A4L1
33C2	01939	3-53 1A6C10	41-642	06978	3-31 1A5A6L1
33C2	01939	3-53 1A6C11	41C92A5	01939	3-49 1A1C2
33C2	01939	3-53 1A6C18	43A159	25140	3-14 1A4A4B1
331026C0H0509C	72982	1A4A3C43	435-1014-000	13499	3-34 1A10C6
331026C0H0509C	72982	1A4A3C45	4422-11-117	82142	1A4A4L35
331026C0H0509C	72982	3-6 1A4A3C41	4422-11-117	82142	1A4A4L37
331026C0H0209C	72982	3-6 1A4A3C32	458-0108-00	13499	3-47 1A3M1
331026C0K0209C	72982	3-6 1A4A3C34	50	72765	3-36 1A3XDS1
338023P2H0430J	72982	1A4A4C55	50	72765	3-49 1A1XDS1
			50	72765	3-52 1A6XDS1

SECTION IV INDEX-FEDERAL STOCK NUMBER AND REFERENCE NUMBER CROSS REFERENCE  
TO FIGURE AND ITEM NUMBER OR REFERENCE DESIGNATION (CONTINUED)

FEDERAL STOCK NUMBER T e x t	FIGURE NUMBER ITEM NUMBER OR REF. DESIGNATION			FEDERAL STOCK NUMBER	FIGURE NUMBER ITEM NUMBER OR REF. DESIGNATION		
	REFERENCE NO.	MFG. CODE	FIG. NO. REFERENCE DESIGNATION		REFERENCE NO.	MFG. CODE	FIG. NO. REFERENCE DESIGNATION
50	7765	3-52	1A6XDS2	522-2363-005	13499	3-1	1A1
506-2068-002	13499	3-	1A4MP15	526-6582-001	13499	3-17	1A4A5L4
506-2068-002	13499	3-3	1A4MP16	526-6930-000	13499	3-24	1A5A5T3
506-2068-002	13499	3-3	1A4MP50	526-693-000	13499	3-26	1A5A4T3
506-2068-002	13499	3-3	1A4MP51	526-6936000	13499	3-32	1A5A6T4
506-2068-002	13499	3-3	1A4MP56	526-7466-001	13499	3-12	1A4A2FL1
506-2068-002	13499	3-3	1A4MP57	526-9307-000	13499	3-31	1A5A6FL1
506-2068-002	13499	3-3	1A4MP58	526-9309-000	13499	3-9	1A4A3A7FL1
506-2068-002	13499	3-3	1A4MP59	526-9311-000	13499	3-25	1A5A4FL1
506-2068-002	13499	3-3	1A4MP80	526-9311-000	13499	3-30	1A5A3A2FL1
506-2068-002	13499	3-3	1A4MP81	526-9312-000	13499	3-23	1A5A5FL1
51-111	72619		1A12DS2	526-9312-000	13499	3-29	1A5A3A1FL1
513502XP56-1	72765	3-35	1A12XDS1	528-0176-005	13499	3-4	1A4A3
515951	44038	3-14	1A4A4K1	53C45	56289		1A4A3A2C35
52-991	72619		1A3DS4	53C45	56289		1A4A3A2C36
522-0388-003	13499	3-39	1A7A4	53C46	56289		1A4A3A2C35
522-0395-003	13499	3-39	1A7A1	53C46	56289		1A4A3A2C36
522-0395-003	13499	3-39	1A7A2	540-6241-002	13499	3-51	1A201
522-0395-003	13499	3-39	1A7A3	541-1505-002	13499		1A7A1Z101
522-0860-013	13499	3-1	1A4	541-6076-002	13499		1A13A2H3
522-0861-034	13499	3-1	1A5	541-6519-002	13499		1A8E9
522-0862-003	13499	3-1	1A10	541-6523-002	13499	3-41	1A7A1TB101
522-0863-006	13499	3-1	1A12	541-6532-003	13499	3-6	1A4A3E19
522-0864-000	13499	3-1	1A3	541-6532-003	13499	3-6	1A4A3E20
522-0963-000	13499	3-1	1A7	541-6532-003	13499	3-6	1A4A3E21
522-0983-005	13499	3-1	1A11	541-6533-003	13499	3-6	1A4A3E22
522-1074-000	13499	3-1	1A8	541-6541-002	13499		1A7A4Z201
522-1398-000	13499	3-1	1A2	541-6550-003	13499	3-6	1A4A3E15
522-1741-000	13499		1A14	541-6550-003	13499	3-6	1A4A3E18
522-1768-014	13499		1A4A3A1	541-6550-003	13499	3-16	1A4A4E9
522-2052-011	13499	1		541-6551-003	13499		1A8E6

SECTION IV INDEX-FEDERAL STOCK NUMBER AND REFERENCE NUMBER CROSS REFERENCE  
TO FIGURE AND ITEM NUMBER OR REFERENCE DESIGNATION (CONTINUED)

FEDERAL STOCK NUMBER		FIGURE NUMBER		ITEM NUMBER OR REF. DESIGNATION		FEDERAL STOCK NUMBER		FIGURE NUMBER		ITEM NUMBER OR REF. DESIGNATION	
REFERENCE NO.	MFG. CODE	FIG. NO.	REFERENCE DESIGNATION	REFERENCE NO.	MFG. CODE	FIG. NO.	REFERENCE DESIGNATION	REFERENCE NO.	MFG. CODE	FIG. NO.	REFERENCE DESIGNATION
541-6551-003	13499	3-6	1A4A3E17	542-3152-004	13499	3-8	1A4A3A6FL1				
341-6531-003	13499	3-16	1A4A4E2	542-3153-004	13499	3-7	1A4A3A3FL1				
541-6551-003	13499	3-16	1A4A4E4	542-3233-002	13499		1A13A1MP7				
541-6551-003	13499	3-16	1A4A4E5	542-3234-002	13499		1A13A1MP9				
541-6551-003	13499	3-16	1A4A4E7	542-3237-002	13499		1A13A1H7				
541-6551-003	13499	3-16	1A4A4E8								
541-6551-003	13499	3-16	1A4A4E10	542-4782-002	13499	3-12	1A4A2E1				
541-6532-003	13499		1A8E7	542-4782-002	13499	3-12	1A4A2E2				
541-6553-003	13499	3-6	1A4A3E16	542-4782-002	13499	3-12	1A4A2E3				
541-6554-003	13499		1A5A7E1	542-4782-002	13499	3-12	1A4A2E4				
541-6554-003	13499	3-16	1A4A4E1	542-4782-002	13499	3-26	1A5A4E2				
541-6554-003	13499	3-16	1A4A4E3	542-4782-002	13499	3-26	1A5A4E3				
541-6554-003	13499	3-52	1A6E1	542-4782-002	13499	3-26	1A5A4E4				
541-6554-003	13499	3-52	1A6E2	542-4782-002	13499	3-27	1A5A2E2				
541-6555-003	13499		1A3E1	542-4782-002	13499	3-28	1A5A2E1				
541-6555-003	13499		1A3E2	542-4782-002	13499	3-28	1A5A2E3				
541-6555-003	13499	3-16	1A4A4E6	542-4782-002	13499	3-32	1A5A6E2				
541-8211-002	13499		1A13A1MP3	542-4782-002	13499	3-32	1A5A6E3				
541-8211-002	13499		1A13A1MP4	542-4782-002	13499	3-32	1A5A6E4				
541-8253-003	13499		1A13A1MP5	542-5381-002	13499	3-6	1A5A3MP9				
542-0371-002	13499	3-19	1A5A1E1	542-5381-002	13499	3-6	1A4A3MP25				
542-0375-002	13499	3-19	1A5A1E2	542-5720-003	13499		1A4A3A5				
542-0375-002	13499	3-24	1A5A5E2	542-6948-002	13499		1A3DS7				
542-0375-002	13499	3-24	1A5A5E3	542-6948-002	13499		1A3DS8				
542-0375-002	13499	3-24	1A5A5E4	542-7288-002	13499	3-17	1A4A5HR1				
542-0916-002	13499	3-57	1A2A1T1	542-7294-002	13499	3-17	1A4A5L1				
542-2000-003	13499		1A13A2W13TBC	542-7386-002	13499	3-34	1A10TB1				
542-2000-003	13499		1A13A2W20TBK	542-7388-002	13499	3-34	1A10TB2				
542-3020-002	13499		1A13A1MP8	542-7414-002	13499		1A3MP9				
542-3021-002	13499		1A13A1MP10	542-7414-002	13499		1A3MP10				
542-3022-002	13499		1A13A1H8	542-7425-003	13499		1A12A2DS2				

TM 11-5820-555-24P

SECTION IV INDEX-FEDERAL STOCK NUMBER AND REFERENCE NUMBER CROSS REFERENCE  
TO FIGURE AND ITEM NUMBER OR REFERENCE DESIGNATION (CONTINUED)

FEDERAL STOCK NUMBER	FIGURE NUMBER	ITEM NUMBER OR REF. DESIGNATION		FEDERAL STOCK NUMBER	FIGURE NUMBER	ITEM NUMBER OR REF. DESIGNATION	
REFERENCE NO.	MFG. CODE	FIG. NO.	REFERENCE DESIGNATION	REFERENCE NO.	MFG. CODE	FIG. NO.	REFERENCE DESIGNATION
542-7428-003	13499		1A3DS5	543-1031-003	13499	3-19	1A5A1TB1
542-7428-003	13499		1A3DS6	543-1089-002	13499	3-17	1A4A5R38
542-7439-003	13499		1A3MP1	543-1351-004	13499	3-18	1A5A3
542-7439-003	13499		1A3MP2	543-1352-003	13499		1A5A3A1
542-7447-003	13499		1A301	543-1353-003	13499		1A5A3A2
542-7447-003	13499	3-57	1A2A201	543-1354-002	13499		1A5A3A1TB1
542-7697-004	13499	3-4	1A4A1	543-1460-003	13499	3-35	1A12S2
542-7699-004	13499	3-5	1A4A1TB1	543-1465-004	13499	3-35	1A12TB2
542-7700-004	13499	3-5	1A4A1Z1	543-1500-004	13499	3-18	1A5A2
542-7705-004	13499	3-5	1A4A1TB2	543-1501-004	13499	3-4	1A4A2
542-7706-004	13499	3-5	1A4A1Z2	543-1633-002	13499	3-6	1A4A3MP29
542-7729-004	13499		1A4A5	543-1633-002	13499	3-6	1A4A3MP30
542-7788-005	13499	3-18	1A5A7	543-1642-002	13499	3-6	1A4A3MP15
543-0274-005	13499	3-18	1A5A5	543-1644-002	13499	3-6	1A4A3MP35
543-0275-005	13499	3-18	1A5A4	543-1646-002	13499	3-6	1A4A3MP5
543-0276-005	13499	3-18	1A5A6	543-1648-002	13499	3-6	1A4A3MP32
543-0304-002	13499	3-37	1A3TB1	543-1650-002	13499	3-6	1A4A3MP1
543-0305-002	13499	3-37	1A3MP8	543-1651-002	13499	3-6	1A4A3MP2
543-0311-002	13499	3-37	1A3MP7	543-1653-002	13499	3-6	1A4A3MP33
543-0316-002	13499	3-37	1A3L11	543-1655-002	13499	3-6	1A4A3MP6
543-0392-002	13499		1A3MP5	543-1688-002	13499	3-6	1A4A3MP13
543-0404-003	13499	3-37	1A3S6	543-1688-002	13499	3-6	1A4A3MP24
5430427-003	13499	3-37	1A3S7	543-1690-002	13499	3-6	1A4A3T2
543-0432-003	13499		1A3MP6	543-1691-002	13499	3-6	1A4A3L2
543-0452-002	13499	3-37	1A3Z3	543-1692-002	13499	3-6	1A4A3L4
543-0452-002	13499	3-37	1A3Z4	543-1692-002	13400	3-6	1A4A3L5
543-0452-002	13499	3-38	1A3Z1	543-1694-002	13499		1A4A3A3L1
543-0452-062	13499	3-38	1A3Z2	543-1694-002	13499		1A4A3A3L2
543-0457-003	13499	3-37	1A3L8	543-1694-002	13499		1A4A3A6L1
543-0459-003	13499	3-37	1A3S5	543-1694-002	13499		1A4A3A6L2
543-0460-003	13499	3-37	1A3L9	543-1696-002	13499		1A4A3A3L3

SECTION IV INDEX-FEDERAL STOCK NUMBER AND REFERENCE NUMBER CROSS REFERENCE  
TO FIGURE AND ITEM NUMBER OR REFERENCE DESIGNATION (CONTINUED)

FEDERAL STOCK NUMBER	FIGURE NUMBER	ITEM NUMBER OR REF. DESIGNATION		FEDERAL STOCK NUMBER	FIGURE NUMBER	ITEM NUMBER OR REF. DESIGNATION	
REFERENCE NO.	MFG. CODE	FIG. NO.	REFERENCE DESIGNATION	REFERENCE NO.	MFG. CODE	FIG. NO.	REFERENCE DESIGNATION
543-1696-002	13499		1A4A3A3L4	543-2000-003	13499		1A13A2W15TBE
543-1696-002	13499		1A4A3A3L5	543-2000-003	13499		1A13A2W17TBE
543-1696-002	13499		1A4A3A3L6	543-2000-003	13499		1A13A2W19TBJ
543-1696-002	13499		1A4A3A3L7	543-2000-003	13499		1A13A2W21TBL
543-1696-002	13499		1A4A3A6L3	543-2000-003	13499		1A13A2W23TBN
543-1696-002	13499		1A4A3A6L4	543-2000-003	13499		1A13A2W25TBR
543-1696-002	13499		1A4A3A6L5	543-2000-003	13499		1A13A2W26TBS
543-1696-002	13499		1A4A3A6L6	543-2293-003	13499	3-16	1A4A4Z16
543-1696-002	13499		1A4A3A6L7	543-2499-003	13499	3-12	1A4A2TB1
543-1724-002	13499	3-6	1A4A3TB2				
543-1736-002	13499	3-6	1A4A3MP36	543-2510-004	13499	3-12	1A4A2Z1
543-1737-002	13499	3-6	1A4A3MP22	543-2514-004	13499		1A4A2Z3
5431753-002	13499	3-6	1A4A3T1	543-2515-004	13499		1A4A2Z2
543-1771-003	13499	3-6	1A4A3Z1	543-2839-002	13499		1A5A7TB1
543-1775-003	13499	3-6	1A4A3Z4	543-2862-002	13499	3-14	1A4A4S10
543-1776-003	13499	3-6	1A4A3Z5	543-2863-002	13499	3-14	1A4A4S9
543-1778-003	13499	3-9	1A4A3A7TB1	543-2864-002	13499	3-14	1A4A4S8
543-1779-003	13499	3-6	1A4A3L6	543-2865-002	13499	3-14	1A4A4S6
543-1779-003	13499	3-6	1A4A3L9	543-2866-002	13499	3-14	1A4A4S4
543-1780-003	13499	3-6	1A4A3L7	543-2868-002	13499	3-14	1A4A4S12
543-1780-003	13499	3-6	1A4A3L8	543-2880-002	13499	3-16	1A4A4MP1
543-1781-003	13499	3-6	1A4A3FL1	543-2880-002	13499	3-16	1A4A4MP2
543-1806-002	13499	3-6	1A4A3MP12	543-2880-002	13499	3-16	1A4A4MP3
543-1844-003	13499	3-28	1A5A2TB1	543-2880-002	13499	3-16	1A4A4MP4
543-1845-003	13499	3-27	1A5A2TB2	543-2882-002	13499	3-16	1A4A4MP5
543-1847-003	13499	3-27	1A5A2L4	543-2882-002	13499	3-16	1A4A4MP6
543-1848-003	13499		1A5A2Z1	543-2888-002	13499		1A4A4MP7
543-1849-003	13499		1A5A2Z2	543-2888-002	13499		1A4A4MP8
543-2000-003	13499		1A13A2W11TBA	543-2920-002	13499	3-14	1A4A4S1
543-2000-003	13499		1A13A2W12TBB	543-2929-002	13499	3-14	1A4A4T2
543-2000-003	13499		1A13A2W14TBD	543-2930-002	13499	3-14	1A4A4T1

SECTION IV INDEX-FEDERAL STOCK NUMBER AND REFERENCE NUMBER CROSS REFERENCE  
TO FIGURE AND ITEM NUMBER OR REFERENCE DESIGNATION (CONTINUED)

FEDERAL STOCK NUMBER	FIGURE NUMBER	ITEM NUMBER OR REF. DESIGNATION		FEDERAL STOCK NUMBER	FIGURE NUMBER	ITEM NUMBER OR REF. DESIGNATION	
REFERENCE NO.	MFG. CODE	FIG. NO.	REFERENCE DESIGNATION	REFERENCE NO.	MFG. CODE	FIG. NO.	REFERENCE DESIGNATION
543-2933-002	13499	3-14	1A4A4S2	543-3006-003	13499	3-16	1A4A4Z29
543-2934-002	13499	3-14	1A4A4S14	543-3066-002	13499	3-3	1A4AMP37
543-2945-002	13499		1A4A4L7	543-3075-002	13499	3-3	1AAMP39
543-2945-002	13499		1A4A4L8	543-3075-002	13499	3-3	1AAMP46
543-2945-002	13499		1A4A4L14	543-3077-002	13499	3-3	1AAMP61
543-2945-002	13499		1A4A4L15	543-3077-002	13499	3-3	1AAMP62
543-2945-002	13499		1A4A4L18	543-3078-002	13499	3-3	1AAMP47
543-2946-002	13499		1A4A4L9	543-3078-002	13499	3-3	1AAMP71
543-2946-002	13499		1A4A4L10	543-3078-002	13499	3-3	1AAMP72
543-2946-002	13499		1A4A4L19	543-3078-002	13499	3-3	1AAMP77
543-2947-002	13499		1A4A4L11	543-3080-002	13499	3-3	1AAMP19
543-2947-002	13499		1A4A4L12	543-3083-000	13499	3-3	1AAMP10
543-2947-002	13499		1A4A4L20	543-3087-002	13499	3-3	1AAMP68
543-2948-002	13499		1A4A4L28	543-3099-002	13499	3-3	1AAMP38
543-2949-002	13499		1A4A4L27	543-3099-002	13499	3-3	1AAMP69
543-2949-002	13499		1A4A4L29	543-3099-002	13499	3-3	1AAMP70
543-2953-003	13499	3-14	1A4ATB1	543-3100-002	13499	3-3	1AAMP12
543-2964-003	13499	3-16	1A4AMP10	543-3102-002	13499	3-3	1AAMP17
543-2984-003	13499	3-16	1A4AZ7	543-3103-002	13499	3-3	1AAMP18
543-2985-003	13499	3-16	1A4AZ8	543-3113-002	13499	3-3	1AAMP22
543-2986-003	13499	3-16	1A4AZ9	543-3121-002	13499	3-3	1AAMP60
543-2941-003	13499	3-16	1A4AZ10	543-3123-002	13499	3-3	1AAMP63
543-2988-003	13499	3-16	1A4AZ11	543-3123-002	13499	3-3	1AAMP64
543-2989-003	13499	3-16	1A4AZ12	543-3124-002	13499	3-3	1AAMP48
543-2990-003	13499	3-16	1A4AZ13	543-3126-002	13499	3-3	1AAMP65
543-2994-003	13499	3-16	1A4AZ17	543-3127-002	13499	3-3	1AAMP67
543-2999-003	13499	3-16	1A4AZ22	543-3128-002	13499	3-3	1AAMP49
543-3000-003	13499	3-16	1A4AZ23	543-3130-002	13499	3-3	1AAMP66
543-3001-003	13499	3-16	1A4AZ24	543-3136-002	13499	3-3	1AAMP29
543-3004-003	13499	3-16	1A4AZ27	543-3145-002	13499	3-3	1AAMP7
543-3005-003	13499	3-16	1A4AZ28	543-3146-002	13499	3-3	1AAMP8



SECTION IV INDEX-FEDERAL STOCK NUMBER AND REFERENCE NUMBER CROSS REFERENCE  
TO FIGURE AND ITEM NUMBER OR REFERENCE DESIGNATION (CONTINUED)

FEDERAL STOCK NUMBER	FIGURE NUMBER	ITEM NUMBER OR REF. DESIGNATION	FEDERAL STOCK NUMBER	FIGURE NUMBER	ITEM NUMBER OR REF. DESIGNATION
REFERENCE NO.	MFG. CODE	FIG. NO. REFERENCE DESIGNATION	REFERENCE NO.	MFG. CODE	FIG. NO. REFERENCE DESIGNATION
543-3150-002	13499	3-3 1A4MP9	544-2583-003	13499	1A13A2W25
543-3152-002	13499	3-3 1A4DS5	544-2618-003	13499	3-12 1A4A2TB2
543-3162-002	13499	3-3 1A4MP30	544-2634-004	13499	3-9 1A4A3A7
543-3165-002	13499	3-3 1A4MP31	544-2638-004	13499	3-8 1A4A3A6TB1
543-3166-002	13499	3-3 1A4MP32	544-2640-004	13499	1A4A3A6
543-3178-002	13499	3-3 1A4MP23	544-2765-003	13499	3-16 1A4A4Z18
543-3192-003	13499	3-3 1A4A4MP36	544-2766-003	13499	3-16 1A4A4Z19
543-3250-002	13499	3-57 1A2A202	544-2767-003	13499	3-16 1A4A4Z20
543-3266-002	13499	1A3TB3	544-5648-004	13499	3-17 1A4A5E15
543-3409-000	13499	3-46 1A11F1	544-6037-002	13499	3-3 1A4MP79
543-3440-002	13499	1A13A2W2	544-7199-000	13499	1A2W1
543-3440-002	13499	1A13A2W5	544-7203-002	13499	1A2A2L2
543-3440-002	13499	1A13A2W6	544-7205-002	13499	1A2A2MP6
543-3440-002	13499	1A13A2W7	544-7228-002	13499	3-37 1A3L1Q
543-3440-002	13499	1A13A2W8	544-7230-000	13499	1A2A2
543-3441-002	13499	1A13A2W9	544-7236-003	13499	3-6 1A4A3Z3
543-3442-002	13499	1A13A2W4	544-9001-000	13499	1A13A1
543-5181-003	13499	3-18 1A5A1	544-9002-004	13499	1A13A1MP1
543-6094-000	13499	3-1 1A9	544-9003-004	13499	1A13A1MP2
543-8129-000	13499	3-1 1A6	544-9007-004	13499	1A13MP8
544-2577-002	13499	1A13A2W26	544-9010-000	13499	3-1 1A13
544-2579-002	13499	1A13A2W13	544-9012-002	13499	1A13MP7
544-2579-002	13499	1A13A2W20	544-9013-003	13499	1A13MP3
544-2580-002	13499	1A13A2W12	544-9014-004	13499	1A13MP1
544-2580-002	13499	1A13A2W15	544-9015-004	13499	1A13MP2
544-2581-002	13499	1A13A2W16	544-9019-000	13499	1A13A2
544-2581-002	13499	1A13A2W18	544-9020-002	13499	1A13A2W14
544-2581-002	13499	1A13A2W22	544-9021-002	13499	1A13A2W1
544-2581-002	13499	1A13A2W24	544-9112-002	13499	3-37 1A3E3
544-2582-002	13499	1A13A2W21	544-9112-002	13499	3-37 1A3E4
544-2582-002	13499	1A13A2W23	544-9113-003	13499	3-37 1A3E5

SECTION IV INDEX-FEDERAL STOCK NUMBER AND REFERENCE NUMBER CROSS REFERENCE  
TO FIGURE AND ITEM NUMBER OR REFERENCE DESIGNATION (CONTINUED)

FEDERAL STOCK NUMBER	FIGURE NUMBER		ITEM NUMBER OR REF. DESIGNATION	FEDERAL STOCK NUMBER	FIGURE NUMBER		ITEM NUMBER OR REF. DESIGNATION
	REFERENCE NO.	MFG. CODE	FIG. NO. REFERENCE DESIGNATION		REFERENCE NO.	MFG. CODE	FIG. NO. REFERENCE DESIGNATION
544-9113-003	13499	3-37	1A3E6	545-9080-003	13499	3-16	1A4A4Z14
544-9788-003	13499	3-12	1A4A2T1	545-9081-003	13499	3-16	1A4A4Z15
545-3048-002	13499		1A13MP5	545-9082-003	13499	3-16	1A4A4Z21
545-3049-002	13499		1A13MP6	545-9083-003	13499	3-16	1A4A4Z25
545-3124-000	13499		1A6A1	545-9084-003	13499	3-16	1A4A4Z26
545-3133-002	13499	3-53	1A6TB1	545-9085-003	13499	3-16	1A4A4Z30
545-3143-003	13499	3-54	1A6A1L1	545-9120-002	13499		1A13A2W10
545-5840-003	13499	3-6	1A4A3Z2	545-9120-002	13499		1A13A2W27
545-5865-005	13499		1A4A3A2TB1	546-2148-005	13499	3-4	1A4A4
545-5866-005	13499		1A4A3A2	546-3425-000	13499		1A13A2W3
545-5928-000	13499		1A14W1	546-7884-004	13499	3-11	1A4A3A8TB1
545-5930-002	13499	3-56	1A14H1	547-1327-002	13499		1A1W3
545-5932-002	13499	3-56	1A14H2	547-1328-002	13499		1A1W2
545-5933-003	13499	3-56	1A14MP2	547-1329-002	13499		1A1W1
545-5935-004	13499	3-56	1A14MP1	547-1380-002	13499		1A5A701
545-7743-002	13499	3-3	1A4MP27	547-1380-002	13499	3-52	1A601
545-7745-002	13499	3-3	1A4MP33	547-1380-002	13499	3-52	1A602
545-9071-002	13499	3-14	1A4A4S15	547-1380-002	13499	3-52	1A603
545-9073-002	13499		1A4A4L1	547-3766-004	13499		1A4A3A3
545-9073-002	13499		1A4A4L2	548-1282-002	13499		1A4A4MP5
545-9073-002	13499		1A4A4L3	548-1284-002	13499	3-14	1A4A4MP11
545-9073-002	13499		1A4A4L4	548-8058-004	13499		1A4A3A8
545-9073-002	13499		1A4A4L5	55C23	56289	3-37	1A3C75
545-9073-002	13499		1A4A4L6	55C43	56289	3-10	1A4A3A2C26
545-9073-002	13499		1A4A4L17	55C43	56289	3-10	1A4A3A2C27
545-9074-003	13499	3-16	1A4A4Z1	553-7199-003	13499		1A3MP17
545-9075-003	13499	3-16	1A4A4Z2	553-7201-003	13499		1A3MP18
545-9076-003	13499	3-16	1A4A4Z3	55701BC0P039R	72982	3-15	1A4A4C25
545-9077-003	13499	3-16	1A4A4Z4	557043U2P034R	72982	3-17	1A4A5C11
545-9078-003	13499	3-16	1A4A4Z5	557043U2P034R	72982	3-17	1A4A5C17
545-9079-003	13499	3-16	1A4A4Z6	5570432P034R	72982	3-17	1A4A5C26

TM 11-5820-555-24P  
SECTION IV INDEX-FEDERAL STOCK NUMBER AND REFERENCE NUMBER CROSS REFERENCE  
TO FIGURE AND ITEM NUMBER OR REFERENCE DESIGNATION (CONTINUED)

FEDERAL STOCK NUMBER	FIGURE NUMBER	ITEM NUMBER OR REF. DESIGNATION	FEDERAL STOCK NUMBER	FIGURE NUMBER	ITEM NUMBER OR REF. DESIGNATION		
REFERENCE NO.	MFG. CODE	FIG. NO.	REFERENCE DESIGNATION	REFERENCE NO.	MFG. CODE	FIG. NO.	REFERENCE DESIGNATION
557043U2P034R	72982	3-17	1A4A5C30	5840	94151	3-28	1A5A2V3
5636	82219	3-7	1A4A3A3V1	5899	82219		1A5A4V1
5636	82219	3-7	1A4A3A3V2	5899	82219	3-19	1A5A1V1
5636	82219	3-8	1A4A3A6V1	5899	82219	3-23	1A5A5V1
5636	82219	3-12	1A4A2V1	5899	82219	3-24	1A5A5V2
5636	82219	3-12	1A4A2V2	5899	82219	3-24	1A5A5V4
5636	82219	3-12	1A4A2V3	5899	82219	3-26	1A5A4V2
5636	82219	3-12	1A4A2V4	5899	82219	3-26	1A5A4V4
5636	82219	3-24	1A5A5V3	5899	82219	3-31	1A5A6V1
5636	82219	3-26	1A5A4V3	5899	82219	3-32	1A5A6V2
5654	89185	3-6	1A4A3V1	5899	82219	3-32	1A5A6V3
5654	89185	3-6	1A4A3V3	5899	82219	3-32	1A5A6V4
5654	89185	3-16	1A4A4V9	6BE6	49671	3-47	1A8V2
5670	89185	3-6	1A4A3V4	6CL6	49671	3-16	1A4A4V6
57-802	78488		1A4A3A8E23	6CL6	86684	3-37	1A3V1
57-802	78488		1A4A3A8E24	6CL6	86684	3-37	1A3V2
57-802	78488		1A4A3A8E25	600-120-1xA	95238	3-6	1A4A3J1
57-802	78488		1A4A3A8E26	600E20SP	74970	3-57	1A2A2C1
57-802	78488		1A4A3A8E27	601Y110M	75382	3-35	1A12TE1
57-802	78488	3-13	1A4A4E24	6021	49956	3-11	1A4A3A8V1
5749	89185	3-16	1A4A4V2	6021	49956	3-27	1A5A2V2
5749	89185	3-16	1A4A4V4	633-013-352G	72932	3-27	1A5A2C4
5749	89185	3-16	1A4A4V5	650C0	96214	3-53	1A6CR1
5749	89185	3-16	1A4A4V7	678506	14674	3-37	1A3C32
5749	89185	3-16	1A4A4V8	678507	14674	3-37	1A3C29
5749	89185	3-16	1A4A4V10	678508	14674	3-37	1A3C30
5750	89185	3-6	1A4A3V2	678509	14674	3-37	1A3C31
5814A	89185	3-16	1A4A4V1	67867	73831	3-34	1A10L1
5814A	89185	3-16	1A4A4V3	710-3855-000	83827	3-37	1A3R18
5814A	89185	3-21	1A5A7V1	71241	56289	3-37	1A3C50
5840	94151	3-27	1A5A2V1	7470-0229	94991	3-6	1A4A3XV1

SECTION IV INDEX-FEDERAL STOCK NUMBER AND REFERENCE NUMBER CROSS REFERENCE  
TO FIGURE AND ITEM NUMBER OR REFERENCE DESIGNATION (CONTINUED)

FEDERAL STOCK NUMBER	FIGURE NUMBER		ITEM NUMBER OR REF. DESIGNATION	FEDERAL STOCK NUMBER	FIGURE NUMBER		ITEM NUMBER OR REF. DESIGNATION
	MFG. CODE	FIG. NO.	REFERENCE DESIGNATION		REFERENCE NO.	MFG. CODE	FIG. NO.
7470-0229	94991	3-6	1A4A3XV2	8506S100N	71590		1A2A2C4
7470-0229	94991	3-6	1A4A3XV3	850S100N	71590		1A2A2C5
7470-9231	94991	3-16	1A4A4XV2	850S100N	71590		1A2A2C6
7470-0231	94991	3-16	1A4A4XV4	850S100N	71590		1A2A2C7
7470-0231	94991	3-16	1A4A4XV5	850S100N	71590		1A2A2C8
7470-0231	94991	3-16	1A4A4XV7	850S100N	71590		1A2A2C9
7470-0231	94991	3-16	1A4A4XV8	850S100N	71590		1A2A2C10
7470-0231	94991	3-16	1A4A4XV9	850S100N	71590		1A2A2C11
7470-0231	94991	3-16	1A4A4XV10	850S12Z	71590	3-37	1A3C10
7490-0189	80368	3-6	1A4A3XV4	850S12Z	71590	3-37	1A3C33
7490-0189	80368	3-20	1A5A7XV1	850S47Z	71590	3-37	1A3C11
7490-0189	80368	3-38	1A3XV1	850S47Z	71590	3-37	1A3C22
7490-0189	80368	3-38	1A3XV2	850S47Z	71590	3-37	1A3C23
7490-0191	94991	3-16	1A4A4XV1	850S47Z	71590	3-37	1A3C24
7490-0191	94991	3-16	1A4A4XV3	850S75Z	71590	3-37	1A3C21
7490-0191	94991	3-16	1A4A4XV6	850S75Z	71590	3-37	1A3C25
74900191	94991	3-53	1A6XV1	850S75Z	71590	3-37	1A3C26
74900191	94991	3-53	1A6XV2	850S75Z	71590	3-37	1A3C27
7580W4CX250R	06980	3-38	1A3V3	850S75Z	71590	3-37	1A3C28
7580W4CX250R	06980	3-38	1A3V4	851-500P3KC101J	72982	3-10	1A4A2A2C26
77R4DXR1KA	43334	3-6	1A4A3MP14	851-500P3KC101J	72982	3-10	1A4A2A2C27
80PC2F	02660	3-42	1A7J5	86P33301S3	56289	3-12	1A4A2C19
808X5T0501M	72982	3-38	1A3C9	86709BM	04009	3-3	1A4S2
81-111PC	72619		1A1E1	88-8TM	02660	3-37	1A3XK1
81410-1PC	72619	3-33	1A10X11	891SP50P10PCTM5PCT	10646	3-56	1A3C81
82661K	76854	3-3	1A4S1	90A781	54715	3-55	1A13A3HT1
83-3243	04221	3-20	1A5A7K1	90A782	54715	3-55	1A13A3MK1
83-3277	04221	3-22	1A2K1	90A789	54715	3-55	1A13A3S1
85C1	01939	3-37	1A3C7	913-3103-000	00656	3-40	1A7A1C105
850S100N	71590		1A2A2C2	922-0528-000	13499		1A3C12
850S100N	71590		1A2A2C3	930-4340-000	00656	3-35	1A12C1

SECTION IV INDEX-FEDERAL STOCK NUMBER AND REFERENCE NUMBER CROSS REFERENCE  
TO FIGURE AND ITEM NUMBER OR REFERENCE DESIGNATION (CONTINUED)

FEDERAL STOCK NUMBER	FIGURE NUMBER	ITEM NUMBER OR REF. DESIGNATION		FEDERAL STOCK NUMBER	FIGURE NUMBER	ITEM NUMBER OR REF. DESIGNATION
<u>REFERENCE NO.</u>	<u>MFG. CODE</u>	<u>FIG. NO.</u>	<u>REFERENCE DESIGNATION</u>			
930-4340-000	00656	3-35	1A12C2			
931-6541-000	00656	3-15	1A4A4C74			
938X1188	83722		1A4A4L13			
94-1551	04221	3-37	1A3K2			
95-2943	04221	3-2	1A4K1			
95-2943	04221	3-16	1A4A4K2			
95-2944	04221	3-12	1A4A2K1			
95-2944	04221	3-12	1A4A2K2			

TM 11-5820-555-24P  
SECTION V INDEX-REFERENCE DESIGNATION  
CROSS REFERENCE TO PAGE NUMBER

REFERENCE DESIGNATION	PAGE NUMBER	REFERENCE DESIGNATION	PAGE NUMBER	REFERENCE DESIGNATION	PAGE NUMBER
1	2-1, 3-1	1A2C2	3-264	1A2A1CR1	3-259
1A1	2-6, 3-222	1A2C3	3-264	1A2A1CR2	3-258
1A1C1	3-226	1A2C4	3-264	1A2A1L1	3-260
1A1C2	3-226	1A2J1	3-259	1A2A1L2	3-260
1A1DS1	2-6, 3-224	1A2J2	3-259	1A2AIR1	3-260
1A1DS2	2-6, 3-224	1A2J8	3-265	1A2AIR2	3-260
1A1E1	2-6, 3-224	1A2J9	3-258	1A2A1R3	3-261
1A1E3	3-224	1A2J9	3-266	1A2A1R4	3-262
1A1E4	3-224	1A2J10	3-266	1A2A1R5	3-260
1A1E5	3-224	1A2J11	3-266	1A2A1R6	3-260
1A1J1	3-225	1A2K1	3-258	1A2AIT1	3-259
1A1J2	3-224	1A2LS1	3-263	1A2A2	2-7, 3-255
1A1J3	3-224	1A2M1	3-264	1A2AC1	3-256
1A1K1	3-225	1A2O1	2-8, 3-258	1A2A2C2	3-256
1A1K2	3-225	1A2P3	3-258	1A2A2C3	3-256
1A1P3	3-225	1A2P4	3-258	1A2A2C4	3-257
1A1P4	3-225	1A2P5	2-266	1A2A1C5	3-257
1A1P5	3-225	1A2R1	3-266	1A2A1C6	3-257
1A1P6	3-225	1A2R2	3-266	1A2A2C7	3-257
1A1R1	3-226	1A2S1	3-264	1A2A2C8	3-257
1A1R2	3-226	1A2S2	3-258	1A2A2C9	3-257
1A1R3	3-226	1A2S3A	3-265	1A2A2C10	3-257
1A1S1	3-224	1A2S3B	3-265	1A2A2C11	3-257
1A1W1	3-225	1A2W1	3-258	1A2A2J3	3-257
1A1W2	3-225	1A2A1	3-258	1A2A2J4	3-257
1A1W3	3-225	1A2A1C1	3-259	1A2A2L1	3-255
1A1XDS1	3-224	1A2A1C2	3-259	1A2A2L2	3-256
1A1XF1	3-224	1A2A1C3	3-259	1A2A2MP6	3-256
1AXF2	3-224	1A2A1C4	3-259	1A2A2MP7	3-256
1A2	3-254	1A2A1C5	3-259	1A2A201	2-7, 3-255
1A2C1	3-264	1A2A1C6	3-259		

SECTION V INDEX-REFERENCE DESIGNATION  
CROSS REFERENCE TO PAGE NUMBER

REFERENCE DESIGNATION	PAGE NUMBER	REFERENCE DESIGNATION	PAGE NUMBER	REFERENCE DESIGNATION	PAGE NUMBER
1A2A202	3-256	1A3C28	3-191	1A3C62	3-181
1A2A203	3-256	1A3C29	3-185	1A3C63	3-181
1A2A204	2-8, 3-256	1A3C30	3-185	1A3C64	3-181
1A2A2S1	3-256	1A3C31	3-185	1A3C65	3-181
1A2A2S2	3-256	1A3C32	3-185	1A3C66	3-181
1A3	2-4, 3-173	1A3C33	3-190	1A3C67	3-181
1A3C1	3-191	1A3C36	3-191	1A3C68	3-181
1A3C2	3-191	1A3C37	3-191	1A3C69	3-191
1A3C3	3-191	1A3C39	3-191	1A3C70	3-192
1A3C4	3-193	1A3C40	3-191	1A3C71	3-192
1A3C5	3-193	1A3C41	3-192	1A3C72	3-200
1A3C6	3-191	1A3C42	3-191	1A3C73	3-200
1A3C7	3-191	1A3C43	3-192	1A3C74	3-191
1A3C8	3-190	1A3C44	3-192	1A3CRI	3-184
1A3C9	3-190	1A3C45	3-191	1A3CR2	3-185
1A3C10	3-190	1A3C46	3-191	1A3CR3	3-185
1A3C11	3-190	1A3C47	3-191	1A3CR4	3-199
1A3C12	3-191	1A3C48	3-192	1A3CR5	3-200
1A3C15	3-186	1A3C49	3-192	1A3CR6	3-200
1A3C16	3-186	1A3C50	3-189	1A3DSI	2-4, 3-174
1A3C17	3-186	1A3C51	3-185	1A3DS4	2-4, 3-175
1A3C18	3-186	1A3C52	3-189	1A3DS5	3-176
1A3C19	3-186	1A3C53	3-184	1A3DS6	3-175
1A3C20	3-190	1A3C54	3-184	1A3DS7	3-176
1A3C21	3-191	1A3C55	3-189	1A3DS8	3-176
1A3C22	3-190	1A3C56	3-191	1A3E1	3-192
1A3C23	3-190	1A3C57	3-181	1A3E2	3-192
1A3C24	3-190	1A3C58	3-181	1A3E3	3-183
1A3C25	3-191	1A3159	3-181	1A3E4	3-183
1A3C26	3-191	1A3C60	3-181	1A3E5	3-186
1A3C27	3-191	1A3C61	3-181	1A3E6	3-186

SECTION V INDEX-REFERENCE DESIGNATION  
CROSS REFERENCE TO PAGE NUMBER (CONTINUED)

REFERENCE DESIGNATION	PAGE NUMBER	REFERENCE DESIGNATION	PAGE NUMBER	REFERENCE DESIGNATION	PAGE NUMBER
1A3F1	2-4, 3-177	1A3MP11	3-189	1A3R28	3-186
1A3J1	3-181	1A3MP17	3-199	1A3R29	3-184
1A3J2	3-187	1A3MP18	3-200	1A3R30	3-180
1A3J3	3-181	1A301	2-4, 3-173	1A3R31	3-180
1A3J4	3-175	1A3R1	3-193	1A3R32	3-180
1A3J5	3-175	1A3R2	3-193	1A3R33	3-180
1A3J6	3-181	1A3R3	3-193	1A3R34	3-180
1A3K1	3-192	1A3R4	3-193	1A3R35	3-180
1A3K2	3-191	1A3R5	3-190	1A3R36	3-200
1A3K3	3-193	1A3R6	3-193	1A3R37	3-193
1A3L1	3-190	1A3R7	3-193	1A3R39	3-199
1A3L3	3-190	1A3R8	3-193	1A3R40	3-199
1A3L4	3-191	1A3R9	3-192	1A3R41	3-199
1A3L5	3-190	1A3R10	3-192	1A3R42	3-199
1A3L6	3-190	1A3R11	3-193	1A3R43	3-199
1A3L7	3-190	1A3R12	3-193	1A3R44	3-199
1A3L8	3-183	1A3R13	3-193	1A3R45	3-199
1A3L9	3-182	1A3R14	3-193	1A3R46	3-199
1A3L10	3-191	1A3R15	3-184	1A3R47	3-199
1A3L11	3-183	1A3R16	3-190	1A3R48	3-200
1A3L12	3-199	1A3R17	3-184	1AR49	3-200
1A3L16	3-191	1A3R18	3-184	1A3S1	3-175
1A3M1	3-175	1A3R19	3-192	1A3S2	3-175
1A3MP1	3-176	1A3R20	3-184	1A3S3	3-175
1A3MP2	3-176	1A3R21	3-184	1A3S4	3-186
1A3MP5	3-186	1A3A22	3-185	1A3S5	3-179
1A3MP6	3-187	1A3R23	3-184	1A3S6	3-178
1A3MP7	3-187	1A3R24	3-193	1A3S7	3-196
1A3MP8	3-187	1A3R25	3-193	1A3S8	3-196
1A3MP9	3-173	1A3R26	3-186	1A3S9	3-175
1A3MP10	3-173	1AR27	3-186	1A3S10	3-192



SECTION V INDEX-REFERENCE DESIGNATION  
 CROSS REFERENCE TO PAGE NUMBER (CONTINUED)

REFERENCE DESIGNATION	PAGE NUMBER	REFERENCE DESIGNATION	PAGE NUMBER	REFERENCE DESIGNATION	PAGE NUMBER
1A3S11	3-199	1A4C11	3-16	1A4DS1	2-1, 3-1
1A3S12	3-199	1AC12	3-16	1A4DS2	2-1, 3-1
1A3T1	3-192	1A4C13	3-16	1A4D53	2-1, 3-1
1A3TB1	3-184	3A4C14	3-16	1ADS4	2-1, 3-1
1ATB3	3-180	1A4C15	3-16	1A4DS5	3-12
1A3V1	2-4, 3-192	1A4C16	3-16	1A4E1	3-1
1A3V2	2-4, 3-192	1A4C17	3-16	1A4E2	3-1
1A3V3	3-192	1A4C18	3-16	1A4E3	3-1
1A3V4	3-192	1A4C19	3-16	1A4E4	3-1
1A3DS1	3-175	1A4C21	3-17	1A4E5	3-18
1A3XF1	3-175	1A4C22	3-17	1A4E6	3-18
1A3XK1	3-189	1A4C23	3-20	1A4E7	3-18
1A3XV1	3-189	1A4C25	3-20	1A4E8	3-18
1A3XV2	3-190	1A4C26	3-20	1A4E9	3-18
1A3XV3	3-190	1A4C28	3-20	1A4E10	3-18
1A3XV4	3-190	1A4C29	3-17	1A4E11	3-18
1A3Z1	3-188	1A4C30	3-17	1A4E13	3-18
1A3Z2	3-188	1A4C31	3-20	1A4E14	3-18
1A3Z3	3-188	1A4C32	3-20	1A4J1	3-6
1A3Z4	3-189	1A4C33	3-17	1A4J2	3-6
1A4	2-1, 3-1	1A4C34	3-17	1A4J3	3-1
1A4C1	3-16	1A4C35	3-20	1A4J4	3-6
1A402	3-16	1A4C36	3-20	1A4J5	3-1
1A403	3-16	1A4C37	3-17	1A4J6	3-1
1A4C4	3-16	1A4C38	3-20	1A4J7	3-6
1A4C5	3-16	1A4C40	3-17	1A4J10	3-3
1A4C6	3-16	1A4C41	3-17	1A4J11	3-3
1A4C7	3-16	1A4C42	3-17	1AJ12	3-3
1A4C8	3-16	1A4C43	3-17	1A4J13	3-3
1A4C9	3-16	1A4C44	3-17	1A4J14	3-3
1A4C10	3-16	1A4C45	3-17	1A4J15	3-3

SECTION V INDEX-REFERENCE DESIGNATION  
 CROSS REFERENCE TO PAGE NUMBER (CONTINUED)

REFERENCE DESIGNATION	REFERENCE DESIGNATION	REFERENCE DESIGNATION
1A4J16	1A4MP17	1A4MP60
1A4J17	1A4MP18	1A4MP61
1A4K1	1A4MP19	1A4MP62
<b>1A4L1</b>	1A4MP22	1A4MP63
1A4L3	1A4MP23	1A4MP64
1A4L4	1A4MP26	1A4MP65
1A4L5	A14MP27	1A4MP66
1A4L6	1A4MP28	1A4MP67
<b>1A4L7</b>	1A4MP29	1A4MP68
<b>1A4L8</b>	1A4MP30	1A4MP69
1A4L9	1A4MP31	1A4MP70
1A4L10	1A4MP32	1A4MP71
1A4L11	1A4MP33	1A4MP72
1A4L12	1A4MP34	1A4MP73
14L13	1A4MP38	1A4MP74
1A4L17	1A4MP39	1A4MP75
1A4M1	1A4MP40	1A4MP76
1A4M2	1A4MP41	1A4MP77
1A4MP2	1A4MP42	1A4MP79
1A4MP3	1A4MP43	1AAMP80
1A4MP4	1A4MP45	1A4MP81
1A4MP5	1A4MP46	1A4MP82
1A4MP6	1A4MP47	1A401
1A4MP7	1AMP48	1A402
1A4MP8	1A4MP49	1A4R1
1A4MP9	1A4MP50	1A4R2
1A4MP10	1A4MP51	1A R 3
1A4MP11	1A4MP56	1A4R4
1A4MP12	1A4MP57	1A4R5
1A4MP15	1A4MP58	1A4S1
1A4MP16	1A4MP59	1A4S2

SECTION V INDEX-REFERENCE DESIGNATION  
 CROSS REFERENCE TO PAGE NUMBER (CONTINUED)

REFERENCE DESIGNATION	PAGE NUMBER	REFERENCE DESIGNATION	PAGE NUMBER	REFERENCE DESIGNATION	PAGE NUMBER
1A4XDS1	2-1, 3-1	1A4A1L1	3-23	1A4A1Z1	3-21
1A4XDS2	2-1, 3-1	1A4A1Q1	3-21	1A4A1Z2	3-23
1A4XDS3	2-1, 3-1	1A4A1Q2	3-21	1A4A2	3-58
1A4XDS4	2-1, 3-1	1A4A1Q3	3-21	1A4A2C1	3-60
1A4A1	3-20	1A4A1Q4	3-21	1A4A2C2	3-61
1A4A1C1	3-23	1A4A1Q5	3-21	1A4A2C3	3-61
1A4A1C2	3-23	1A4A1Q6	3-23	1A4A1C4	3-61
1A4A1C3	3-22	1A4A1Q7	3-23	1A4A1C5	3-60
1A4A1C4	3-23	1A4A1R1	3-22	1A4A2C6	3-61
1A4A1C5	3-23	1A4A1R2	3-22	1A4A2C7	3-61
1A4A1C6	3-23	1A4A1R3	3-22	1A4A2C8	3-61
1A4A1C7	3-23	1A4A1R4	3-22	1A4A2C9	3-61
1A4A1C8	3-24	1A4A1R5	3-23	1A4A2C10	3-61
1A4A1C9	3-24	1A4A1R6	3-22	1A4A2C11	3-61
1A4A1C10	3-24	1A4A1R7	3-22	1A4A2C12	3-61
1A4A1C11	3-24	1A4A1R8	3-22	1A4A2C13	3-61
1A4A1C12	3-24	1A4A1R9	3-22	1A4A2C14	3-61
1A4A1C13	3-24	1A4A1R10	3-22	1A4A2C15	3-61
1A4A1C14	3-24	1A4A1R11	3-22	1A4A2C16	3-61
1A4A1C15	3-24	1A4A1R12	3-23	1A4A2C17	3-61
1A4A1C16	3-23	1A4A1R13	3-23	1A4A2C18	3-62
1A4A1CR1	3-22	1A4A1R14	3-23	1A4A2C19	3-63
1A4A1CR3	3-22	1A4A1R15	3-23	1A4A2C20	3-63
1A4A1CR4	3-22	1A4A1R16	3-24	1A4A2C21	3-63
1A4A1CR5	3-22	1A4A1R17	3-24	1A4A2C22	3-62
1A4A1CR6	3-22	1A4A1R18	3-23	1A4A2C23	3-63
1A4A1CR7	3-23	1A4A1T1	3-23	1A4A2C24	3-62
1A4A1CR8	3-23	1A4A1T2	3-23	1A4A2C25	3-63
1A4A1J1	3-22	1A4A1T3	3-23	1A4A2C26	3-63
1A4A1J2	3-22	1A4A1TB1	3-22	1A4A2C27	3-63
1A4A1J3	3-22	1A4A1TB2	3-23	1A4A2C28	3-63

TM 11-5820-555-24P  
SECTION V INDEX-REFERENCE DESIGNATION  
CROSS REFERENCE PAGE NUMBER

REFERENCE DESIGNATION	PAGE NUMBER	REFERENCE DESIGNATION	PAGE NUMBER	REFERENCE DESIGNATION	PAGE NUMBER
1A4A2C29	3-63	1A4A2R16	3-62	1A4A3C11	3-38
1A4A2C30	3-63	1A4A2R17	3-62	1A4A3C12	3-39
1A4A2C31	3-61	1A4A2R18	3-62	1A4A3C13	3-33
1A4A2C32	3-63	1A4A2R19	3-63	1A4A3C14	3-39
1A4A2E1	3-58	1A4A2R20	3-62	1A4A3C15	3-33
1A4A2E2	3-58	1A4A2R21	3-62	1A4A3C16	3-33
1A4A2E3	3-58	1A4A2T1	3-62	1A4A3C17	3-33
1A4A2E4	3-58	1A4A2TB1	3-60	1A4A3C18	3-57
1A4A2FL1	3-64	1A4A2TB2	3-62	1A4A3C19	3-30
1A4A2J1	3-59	1A4A2V1	3-60	1A4A3C20	3-33
1A4A2K1	3-61	1A4A2V2	3-60	1A4A3C21	3-33
1A4A2K2	3-61	1A4A2V3	3-62	1A4A3C22	3-33
1A4A2L1	3-59	1A4A2V4	3-62	1A4A3C23	3-33
1A4A2L3	3-62	1A4A2XY1	3-59	1A4A3C24	3-33
1A4A2Q1	3-60	1A4A2Y1	3-63	1A4A3C25	3-33
1A4A2Q2	3-60	1A4A2Y2	3-63	1A4A3C26	3-33
1A4A2R1	3-60	1A4A2Y3	3-63	1A4A3C27	3-31
1A4A2R2	3-61	1A4A2Y4	3-63	1A4A3C28	3-33
1A4A2R3	3-60	1A4A2Z1	3-62	1A4A3C29	3-39
1A4A2R4	3-60	1A4A2Z2	3-61	1A4A3C30	3-39
1A4A2R5	3-60	1A4A2Z3	3-59	1A4A3C31	3-33
1A4A2R6	3-60	1A4A3	3-24	1A4A3C32	3-33
1A4A2R7	3-60	1A4A3C2	3-35	1A4A3C33	3-33
1A4A2R7	3-60	1A4A3C3	3-37	1A4A3C34	3-33
1A4A2R9	3-60	1A4A3C4	3-37	1A4A3C35	3-39
1A4A2R10	3-60	1A4A3C5	3-33	1A4A3C36	3-39
1A4A2R11	3-60	1A4A3C6	3-33	1A4A3C37	3-30
1A4A2R12	3-60	1A4A3C7	3-38	1A4A3C38	3-33
1A4A2R13	3-61	1A4A3C8	3-38	1A4A3C39	3-35
1A4A2R14	3-60	1A4A3C9	3-33	1A4A3C40	3-34
1A4A2R15	3-63	1A4A3C10	3-33	1A4A3C41	3-40

SECTION V INDEX-REFERENCE DESIGNATION  
CROSS REFERENCE TO PAGE NUMBER

REFERENCE DESIGNATION	PAGE NUMBER	REFERENCE DESIGNATION	PAGE NUMBER	REFERENCE DESIGNATION	PAGE NUMBER
1A4A3C42	3-40	1A4A3J12	3-39	1A4A3MP30	3-27
1A4A3C43	3-36	1A4A3J13	3-38	1A4A3MP32	3-28
1A4A3C44	3-36	1A4A3L1	3-34	1A4A3MP33	3-28
1A4A3C45	3-40	1A4A3L2	3-38	1A4A3MP35	3-28
1A4A3C46	3-40	1A4A3L3	3-32	1A4A3MP36	3-28
1A4A3CR1	3-30	1A4A3L4	3-39	1A4A3P1	3-35
1A4A3CR2	3-30	1A4A3L5	3-39	1A4A3R2	3-34
1A4A3CR3	3-31	1A4A3L6	3-34	1A4A3R3	3-32
1A4A3CR4	3-31	1A4A3L7	3-40	1A4A3R4	3-32
1A4A3CR5	3-31	1A4A3L8	3-40	1A4A3R5	3-33
1A4A3CR6	3-31	1A4A3L9	3-36	1A4A3R6	3-32
1A4A3CR7	3-30	1A4A3MP1	3-27	1A4A3R7	3-32
1A4A3E15	3-25	1A4A3MP2	3-27	1A4A3R8	3-32
1A4A3E16	3-26	1A4A3MP5	3-28	1A4A3R9	3-32
1A4A3E17	3-26	1A4A3MP6	3-29	1A4A3R10	3-32
1A4A3E18	3-25	1A4A3MP8	3-27	1A4A3R11	3-32
1A4A3E19	3-31	1A4A3MP9	3-29	1A4A3R13	3-33
1A4A3E20	3-31	1A4A3MP12	3-28	1A4A3R14	3-33
1A4A3E21	3-31	1A4A3MP13	3-37	1A4A3R15	3-32
1A4A3E22	3-31	1A4A3MP14	3-37	1A4A3R16	3-32
1A4A3E30	3-31	1A4A3MP15	3-31	1A4A3R17	3-32
1A4A3FL1	3-39	1A4A3MP16	3-27	1A4A3R18	3-32
1A4A3J1	3-34	1A4A3MP17	3-27	1A4A3R20	3-32
1A4A3J2	3-31	1A4A3MP18	3-27	1A4A3R21	3-32
1A4A3J3	3-38	1A4A3MP19	3-27	1A4A3R22	3-32
1A4A3J4	3-34	1A4A3MP22	3-28	1A4A3R23	3-33
1A4A3J5	3-34	1A4A3MP24	3-37	1A4A3R28	3-35
1A4A3J6	3-35	1A4A3MP25	3-29	1A4A3R29	3-32
1A4A3J7	3-34	1A4A3MP27	3-24	1A4A3R31	3-32
1A4A3J8	3-35	1A4A3MP28	3-24	1A4A3R32	3-34
1A4A3J9	3-35	1A4A3MP29	3-27	1A4A3R33	3-58

SECTION V INDEX-REFERENCE DESIGNATION  
 CROSS REFERENCE TO PAGE NUMBER (CONTINUED)

REFERENCE DESIGNATION	PAGE NUMBER	REFERENCE DESIGNATION	PAGE NUMBER	REFERENCE DESIGNATION	PAGE NUMBER
1A4A3T1	3-37	1A4A3A2C17	3-54	1A4A3A2Q4	3-52
1A4A3T2	3-38	1A4A3A2C18	3-54	1A4A3A2Q5	3-52
1A4A3TB2	3-32	1A4A3A2C19	3-54	1A4A3A2Q6	3-52
1A4A3V1	2-1, 3-24	1A4A3A2C20	3-53	1A4A3A2R4	3-52
1A4A3V2	2-1, 3-24	1A4A3A2C22	3-54	1A4A3A2R5	3-54
1A4A3v3	2-1, 3-24	1A4A3A2C26	3-53	1A4A3A2R6	3-53
1A4A3v4	2-1, 3-24	1A4A3A2C27	3-53	1A4A3A2R7	3-52
1A4A3XV1	3-30	1A4A3A2C28	3-51	1A4A3A2R8	3-52
1A4A3xv2	3-30	1A4A3AC29	3-53	1A4A3A2R10	3-52
1A4A3XV3	3-30	1A4A3A2C30	3-53	1A4A3A2R11	3-52
1A4A3xv4	3-30	1A4A3A2C31	3-53	1A4A3A2R12	3-52
1A4A3Z1	3-37	1A4A3A2C32	3-53	1A4A3A2R13	3-52
1A4A3Z2	3-38	1A4A3A2C33	3-53	1A4A3A2R14	3-52
1A4A3Z3	3-38	1A4A3A2C34	3-54	1A4A3A2R15	3-52
1A4A3z4	3-39	1A4A3A2C35	3-55	1A4A3A2R16	3-52
1A4A3Z5	3-39	1A4A3A2C36	3-55	1A4A3A2R17	3-52
1A4A3AI	3-58	1A4A3A2C37	3-53	1A4A3A2R18	3-52
1A4A3A2	3-50	1A4A3A2CR1	3-51	1A4A3A2R19	3-52
1A4A3A2C1	3-54	1A4A3A2CR2	3-51	1A4A3A2R21	3-52
1A4A3A2C2	3-53	1A4A3A2CR3	3-51	1A4A3A2R24	3-52
1A4A3A2C5	3-53	1A4A3A2cR4	3-52	1A4A3A2R25	3-52
1A4A3A2C6	3-53	1A4A3A2CRS	3-51	1A4A3A2R26	3-52
1A4A3A2C7	3-53	1A4A3A2CR6	3-51	1A4A3A2R27	3-53
1A4A3A2C8	3-51	1A4A3A2F9	3-52	1A4A3A2R28	3-52
1A4A3A2C9	3-54	1A4A3A2J1	3-51	1A4A3A2R29	3-52
1A4A3A2C10	3-51	1A4A3A2J2	3-51	1A4A3A2R30	3-54
1A4A3A2C12	3-54	1A4A3A2L1	3-51	1A4A3A2R31	3-52
1A4A3A2C13	3-53	1A4A3A2L2	3-51	1A4A3A2T1	3-51
1A4A3A2C14	3-54	1A4A3A2L3	3-51	1A4A3A2T2	3-51
1A4A3A2C15	3-54	1A4A3A2L4	3-51	1A4A3A2T3	3-51
1A4A3A2C16	3-53	1A4A3A2Q3	3-52	1A4A3A2T4	3-51

T M 1 - 5 8 2 0 - 5 5 5 - 2 4 P  
SECTION V INDEX-REFERENCE DESIGNATION  
CROSS REFERENCE TO PAGE NUMBER (continued)

REFERENCE DESIGNATION	PAGE NUMBER	REFERENCE DESIGNATION	PAGE NUMBER	REFERENCE DESIGNATION	PAGE NUMBER
1A4A3A2TB1	3-50	1A4A3A3R6	3-41	1A4A2A6FL1	<del>3-45</del>
1A4A3A3	3-41	1A4A3A3R7	3-41	1A4A3A6L1	3-46
1A4A3A3C1	3-41	1A4A3A3R8	3-41	1A4A3A6L2	3-46
1A4A3A3C3	3-41	1A4A3A3R9	3-41	1A4A3A6L3	3-46
1A4A3A306	3-41	1A4A3A3R10	3-41	1A4A3A6L4	3-46
1A4A3A3C7	3-41	1A4A3A3R11	3-41	1A4A3A6L5	3-46
1A4A3A3C8	3-41	1A4A3A3T1	3-41w	1A4A3A6L6	<del>3-46</del>
1A4A3A309	<del>3-42</del>	1A4A3A3V1	3-42	1A4A3A6L7	3-46
1A4A3A3C10	3-41	1A4A3A3V2	3-42	1A4A3A6Q1	3-45
1A4A3A3C11	3-41	1A4A3A5	3-57	1A4A3A6Q2	3-45
1A4A3A3C12	3-44	1A4A3A6	3-44	1A4A3A6Q3	3-45
1A4A3A3C13	3-44	1A4A3A6C1	3-48.	1A4A3A6R3	3-47
1A4A3A3C14	3-44	1A4A3A6C3	3-48	1A4A3A6R4	3-47
1A4A3A3C15	3-43	1A4A3A6C4	3-45	1A4A3A6R5	3-47
1A4A3A3C16	3-43	1A4A3A6C5	3-48	1A4A3A6R7	3-47
1A4A3A3C17	3-44	1A4A3A606	3-46	1A4A3A6R8	3-48
1A4A3A3C18	3-43	1A4A3A6C7	3-45	1A4A3A6R10	3-47
1A4A3A3FL1	3-42	1A4A3A6C8	3-45	1A4A3A6R11	3-47
1A4A3A3FL2	3-44	1A4A3A6C9	3-45	1A4A3A6R12	3-47
1A4A3A3L1	3-43	1A4A3A6C10	3-46	1A4A3A6R13	3-47
1A4A3A3L2	3-43	1A4A3A6C11	3-45	1A4A3A6R14	3-47
1A4A3A3L3	3-43	1A4A3A6C12	3-47	1A4A3A6R15	3-47
1A4A3A314	3-43	1A4A3A6C13	3-45	1A4A3A6R16	3-47
1A4A23A3L5	3-43	1A4A3A6C14	3-47	1A4A3A617	3-47
1A4A3A3L6	3-43	1A4A3A6C15	3-46	1A4A3A6R20	3-47
1A4A3A3L7	3-43	1A4A3A6C16	3-46	1A4A3A6T1	3-44
1A4A3A3R1	3-41	1A4A3A6C17	3-47	1A4A3A6TB1	3-44
1A4A3A3R2	3-41	1A4A3A3C18	3-46	1A4A3A6V1	3-48
1A4A3A3R3	3-41	1A4A3A6CR1	3-45	1A4A3A7	3-48
1A4A3A3R4	3-41	1A4A3A6CR2	3-45	1A4A3A7C1	3-49
1A4A3A3RT5	3-41	1A4A3A6CR3	3-45	1A4A3A7C2	3-49

TM-11-5820-555-24P  
SECTION v INDEX-REFERENCE DESIGNATION

CROSS REFERENCE TO PAGE NUMBER (continued)

REFERENCE DESIGNATION	PAGE NUMBER	REFERENCE DESIGNATION	PAGE NUMBER	REFERENCE DESIGNATION	PAGE NUMBER
1A4A3A7C3	3-50	1A4A3A7R11	3-49	1A4A4C6	3-85
1A4A3A7C5	3-49	1A4A3A7R12	3-49	1A4A4C7	3-85
1A4A3A7C6	3-50	1A4A3AR13	3-50	1A4AAC8	3-81
1A4A3A7C7	3-48	1A4A3A7R14	3-49	1A4A4C9	3-85
1A4A3A7C8	3-50	1A4A3A7R15	3-50	1A4A4C10	3-85
1A4A3A7C9	3-50	1A4A3A7T1	3-48	1A4A4C11	<b>3-66</b>
1A4A3A7C10	3-49	1A4A3A7T2	3-48	1A4A4C12	3-81
1A4A3A7C11	3-50	1A4A3A7TB1	3-48	1A4A4C13	3-67
1A4A3A7C12	3-48	1A4A3A8	3-55	1A4A4C14	3-86
1A4A3AC13	3-50	1A4A3A8CR1	3-56	1A4A4C15	3-81
1A4A3A7C14	3-50	1A4A3A8CR2	3-56	1A4A4C16	3-86
1A4A3A7c15	3-48	1A4A3A8E23	3-57	1A4A4c17	3-65
1A4A3A7c16	3-50	1A4A3A8E24	3-57	1A4A4C188	3-86
1A4A3A7cR1	3-50	1A4A3A8E25	3-57	1A4A4C19	3-86
1A4A3A7CR2	3-48	1A4A3A8E26	3-57	1A4A4C20	3-87
1A4A3A7FL1	3-48	1A4A3A8E27	3-57	1A4A4C21	3-81
1A4A3A7J1	3-49	1A4A3A8R1	3-56	1A4A4C22	3-87
1A4A3A7J2	3-49	1A4A3A8R2	3-56	1A4A4C23	3-65
1A4A3A7L1	3-48	1A4A3A8R3	3-56	1A4A4C24	3-87
1A4A3A7L2	3-48	1A4A3A8R5	3-56	1A4A4C25	3-73
1A4A3A7Q1	3-48	1A4A3A8R6	3-56	1A4A4C26	3-81
1A4A3A7Q2	3-48	1A4A3A8R7	3-56	1A4A4C27	3-67
1A4A3A7Q3	3-48	1A4A3A8TB1	3-55	1A4A4C28	3-87
1A4A3A7R1	3-49	1A4A3A8V1	3-56	1A4A4C29	3-87
1A4A3A7R2	3-49	1A4A4	2-1, 3-64	1A4A4C30	3-88
1A4A3A7R3	3-49	1A4A4B1	3-77	1A4A4C31	<b>3-87</b>
1A4A3A7R5	3-49	1A4A4C1	3-65	1A4A4C32	<b>3-88</b>
1A4A3A7R6	3-49	1A4A4C2	3-85	1A4A4C33	3-88
1A4A3A7R8	3-49	1A4A4C3	3-85	1A4A4C34	3-88
1A4A3A7R9	3-50	1A4A4C4	3-65	1A4A4C35	3-88
1A4A3A7R10	3-50	1A4A4C5	3-81	1A4A4C36	3-88



**SECTION v INDEX-REFERENCE DESIGNATION  
CROSS REFERENCE TO PAGE NUMBER (CONTINUED)**

REFERENCE DESIGNATION	PAGE NUMBER	REFERENCE DESIGNATION	PAGE NUMBER	REFERENCE DESIGNATION	PAGE NUMBER
1A4A4C37	3-68	1A4A4C68	3-92	1A4A4C100	3-65
1A4A4C38	3-73	1A4A4C69	3-92	1A4A4c101	3-78
1A4A4C39	3-89	1A4A4c70	3-68	1A4A4C102	3-65
1A4A4C40	3-89	1A4A4C71	3-93	1A4A4C103	3-78
1A4A4C41	3-89	1A4A4C73	3-93	1A4A4C104	3-65
1A4A4C42	3-90	1A4A4c74	3-68	1A4A4c106	3-78
1A4A4C43	3-89	1A4A4c75	3-70	1A4A4C107	3-78
1A4A4C44	3-65	1A4A4C76	3-70	1A4A4C108	3-65
1A4A4C45	3-65	1A4A4c77	3-93	1A4A4C109	<del>3-66</del>
1A4A4C46	3-68	1A4A4c78	3-93	1A4A4c110	3-78
1A4A4C47	3-65	1A4A4c79	3-93	1A4A4C111	3-65
1A4A4C48	3-68	1A4A4C80	3-94	1A4A4C112	3-65
1A4A4C49	3-90	1A4A4c81	3-94	1A4A4c115	3-78
1A4A4C50	3-90	1A4A4C82	3-94	1A4A4C116	3-65
1A4A4C51	3-90	1A4A4C83	3-94	1A4A4c117	3-78
1A4A4C52	3-90	1A4A4C84	3-94	1A4A4C118	3-95
1A4A4C53	3-90	1A4A4C85	3-94	1A4A4C119	3-95
1A4A4C54	3-90	1A4A4C86	3-94	1A4A4C120	3-95
1A4A4c55	3-91	1A4A4C87	3-95	1A4A4c121	<del>3-66</del>
1A4A4C56	3-91	1A4A4C88	3-95	1A4A4c122	3-65
1A4A4C57	3-91	1A4A4C89	3-95	1A4A4C123	3-78
1A4A4C58	3-92	1A4A4C90	3-78	1A4A4c125	3-96
1A4A4C59	3-91	1A4A4C91	3-96	1A4A4C129	3-96
1A4A4c60	3-91	1A4A4C92	3-65	1A4A4C130	3-96
1A4A4C61	<del>3-66</del>	1A4A4C93	3-81	1A4A4C131	3-96
1A4A4C62	3-81	1A4A4C94	3-67	1A4A4C132	3-65
1A4A4C63	3-65	1A4A4c95	3-65	1A4A4C133	3-78
1A4A4c64	3-92	1A4A4C96	3-78	1A4A4C134	3-65
1A4A4C65	3-92	1A4A4C97	3-78	1A4A4C135	3-65
1A4A4C66	3-68	1A4A4C98	3-78	1A4A4c137	3-97
1A4A4C67	3-78	1A4A4C99	3-65	1A4A4C138	3-97

SECTION v INDEX-REFERENCE DESIGNATION  
CROSS REFERENCE TO PAGE NUMBER (continued)

REFERENCE DESIGNATION	PAGE NUMBER	REFERENCE DESIGNATION	PAGE NUMBER	REFERENCE DESIGNATION	PAGE NUMBER
1A4A4C139	3-67	1A4A4C184	3-81	1A4A4J13	3-76
1A4A4C140	3-97	1A4A4C185	3-68	1A4A4J14	3-76
1A4A4C141	3-97	1A4A4C186	3-72	1A4A4J15	3-76
1A4A4C142	3-66	1A4A4CR1	3-83	1A4A4J16	3-76
1A4A14C144	3-67	1A4A4CR2	3-80	1A4A4K1	3-70
1A4A4C145	3-67	1A4A4CR3	3-80	1A4A4K2	3-98
1A4A4C146	3-80	1A4A4E1	3-98	1A4A4L1	3-84
1A4A4C148	3-98	1A4A4E2	3-99	1A4A4L2	3-85
1A4A4C149	3-98	1A4A4E3	3-98	1A4A4L3	3-85
1A4A4C159	3-78	1A4A4E4	3-99	1A4A4L4	3-86
1A4A4C160	3-78	1A4A4E5	3-99	1A4A4L5	3-86
1A4A4C161	3-78	1A4A4E6	3-99	1A4A4L6	3-86
1A4A4C162	3-78	1A4A4E7	3-99	1A4A4L7	3-87
1A4A4C163	3-78	1A4A4E8	3-99	1A4A4L8	3-87
1A4A4C164	3-78	1A4A4E9	3-99	1A4A4L9	3-88
1A4A4C165	3-78	1A4A4E10	3-99	1A4A4L10	3-88
1A4A4C166	3-78	1A4A4E22	3-76	1A4A4L11	3-89
1A4A4C167	3-78	1A4A4E24	3-100	1A4A4L12	3-89
1A4A4C168	3-79	1A4A4E28	3-101	1A4A4L13	3-89
1A4A4C169	3-79	1A4A4J1	3-76	1A4A4L14	3-92
1A4A4C171	3-83	1A4A4J2	3-85	1A4A4L15	3-92
1A4A4C172	3-79	1A4A4J3	3-76	1A4A4L17	3-93
1A4A4C173	3-79	1A4A4J4	3-86	1A4A4L18	3-94
1A4A4C174	3-66	1A4A4J5	3-76	1A4A4L19	3-94
1A4A4C175	3-79	1A4A4J6	3-76	1A4A4L20	3-95
1A4A4C176	3-97	1A4A4J7	3-76	1A4A4L21	3-71
1A4A4C177	3-71	1A4A4J8	3-76	1A4A4L22	3-65
1A4A4C178	3-72	1A4A4J9	3-76	1A4A4L23	3-65
1A4A4C179	3-66	1A4A4J10	3-76	1A4A4L24	3-65
1A4A4C180	3-66	1A4A4J11	3-76	1A4A4L25	3-65
1A4A4C183	3-66	1A4A4J12	3-76	1A4A4L26	3-96

SECTION v INDEX-REFERENCE DESIGNATION  
CROSS REFERENCE TO PAGE NUMBER (CONTINUED)

REFERENCE DESIGNATION	PAGE NUMBER	REFERENCE DESIGNATION	PAGE NUMBER	REFERENCE DESIGNATION	PAGE NUMBER
1A4A4L27	3-96	1A4A4R7	3-66	1A4A4R39	3-71
1A4A4L28	3-97	1A4A4R8	3-66	1A4A4R40	3-66
1A4A4L29	3-97	1A4A4R9	3-67	1A4A4R55	3-67
1A4A4L32	3-83	1A4A4R10	3-66	1A4A4R56	3-66
1A4A4L33	3-69	1A4A4R11	3-66	1A4A4R57	3-68
1A4A4L34	3-65	1A4A4R12	3-66	1A4A4R58	3-83
1A4A4L35	3-81	1A4A4R13	3-68	1A4A4R59	3-78
1A4A4L36	3-72	1A4A4R15	3-67	1A4A4R60	3-67
1A4A4L37	3-81	1A4A4R16	3-68	1A4A4R62	3-67
1A4A4MP1	3-81	1A4A4R17	3-66	1A4A4R63	3-80
1A4A4MP2	3-81	1A4A4R18	3-66	1A4A4R65	3-68
1A4A4MP3	3-81	1A4A4R19	3-67	1A4A4R66	3-72
1A4A4MP4	3-81	1A4A4R20	3-67	1A4A4R67	3-80
1A4A4MP5	3-82	1A4A4R21	3-67	1A4A4S1	3-75
1A4A4MP6	3-82	1A4A4R22	3-67	1A4A4S2	3-72
1A4A4MP7	3-100	1A4A4R23	3-66	1A4A4S4	3-73
1A4A4MP8	3-100	1A4A4R24	3-67	1A4A4S6	3-73
1A4A4MP10	3-82	1A4A4R25	3-66	1A4A4S8	3-74
1A4A4MP11	3-84	1A4A4R26	3-66	1A4A4S9	3-74
1A4A4MP12	3-83	1A4A4R27	3-67	1A4A4S10	3-71
1A4A4MP13	3-83	1A4A4R28	3-73	1A4A4S12	3-75
1A4A4MP36	3-101	1A4A4R29	3-67	1A4A4S14	3-71
1A4A4MP37	3-101	1A4A4R30	3-67	1A4A4S15	3-72
1A4A4P1	3-79	1A4A4R31	3-66	1A4A4T1	3-80
1A4A4P2	3-79	1A4A4R32	3-67	1A4A4T2	3-80
1A4A4R1	3-66	1A4A4R33	3-67	1A4A4T2A	3-80
1A4A4R2	3-66	1A4A4R34	3-66	1A4A4TB1	3-83
1A4A4R3	3-66	1A4A4R35	3-66	1A4A4V1	2-1, 3-98
1A4A4R4	3-67	1A4A4R36	3-67	1A4A4V2	2-2, 3-98
1A4A4R5	3-67	1A4A4R37	3-67	1A4A4V3	2-2, 3-98
1A4A4R6	3-67	1A4A4R38	3-67	1A4A4V4	2-2, 3-98

SECTION v INDEX-REFERENCE DESIGNATION  
CROSS REFERENCE TO PAGE NUMBER (CONTINUED)

REFERENCE DESIGNATION	PAGE NUMBER	REFERENCE DESIGNATION	PAGE NUMBER	REFERENCE DESIGNATION	PAGE NUMBER
1A4A4V5	2-2, 3-98	1A4A4Z16	3-91	1A4A5C16	3-105
1A4A4V6	2-2, 3-98	1A4A4Z17	3-91	1A4A5C17	3-106
1A4A4V7	2-2, 3-98	1A4A4Z18	3-92	1A4A5C18	3-106
1A4A4V8	2-2, 3-98	1A4A4Z19	3-92	1A4A5C19	3-106
1A4A4V9	2-2, 3-98	1A4A4Z20	3-92	1A4A5C20	3-111
1A4A4V10	2-2, 3-98	1A4A4Z21	3-93	1A4A5C21	3-106
1A4A4XV1	3-69	1A4A4Z22	3-93	1A4A5C22	3-106
1A4A4XV2	3-70	1A4A4Z23	3-94	1A4A5C23	3-106
1A4A4XV3	3-69	1A4A4Z24	3-94	1A4A5C24	3-105
1A4A4XV4	3-70	1A4A4Z25	3-95	1A4A5C25	3-105
1A4A4XV5	3-70	1A4A4Z26	3-95	1A4A5C26	3-106
1A4A4XV6	3-69	1A4A4Z27	3-96	1A4A5C27	3-106
1A4A4XV7	3-70	1A4A4Z28	3-96	1A4A5C29	3-106
1A4A4XV8	3-70	1A4A4Z29	3-97	1A4A5C30	3-106
1A4A4XV9	3-70	1A4A4Z30	3-97	1A4A5C31	3-106
1A4A4XV10	3-70	1A4A5	3-102	1A4A5C32	3-105
1A4A4Z1	3-84	1A4A5C1	3-105	1A4A5C33	3-105
1A4A4Z2	3-85	1A4A5C2	3-108	1A4A5C34	3-106
1A4A4Z3	3-85	1A4A5C3	3-105	1A4A5C35	3-112
1A4A4Z4	3-85	1A4A5C4	3-105	1A4A5C36	3-105
1A4A4Z5	3-86	1A4A5C5	3-106	1A4A5C37	3-106
1A4A4Z6	3-86	1A4A5C6	3-105	1A4A5C38	3-111
1A4A4Z7	3-16	1A4A5C7	3-105	1A4A5CB1	3-107
1A4A4Z8	3-87	1A4A5C8	3-105	1A4A5CR1	3-107
1A4A4Z9	3-88	1A4A5C9	3-105	1A4A5CR2	3-107
1A4A4Z10	3-88	1A4A5C10	3-105	1A4A5CR3	3-106
1A4A4Z11	3-88	1A4A5C11	3-106	1A4A5E1	3-107
1A4A4Z12	3-89	1A4A5C12	3-105	1A4A5E2	3-107
1A4A4Z13	3-89	1A4A5C13	3-105	1A4A5E3	3-107
1A4A4Z14	3-90	1A4A5C14	3-105	1A4A5E4	3-107
1A4A4Z15	3-90	1A4A5C15	3-105	1A4A5E5	3-107

SECTION v INDEX-REFERENCE DESIGNATION  
 CROSS REFERENCE TO PAGE NUMBER (CONTINUED)

REFERENCE DESIGNATION	PAGE NUMBER	REFERENCE DESIGNATION	PAGE NUMBER	REFERENCE DESIGNATION	PAGE NUMBER
1A4A5E6	3-107	1A4A5R1	3-108	1A4A5R36	3-106
1A4A5E7	3-107	1A4A5R2	3-109	1A4A5R37	3-104
1A4A5E8	3-107	1A4A5R3	3-108	1A4A5R38	3-104
1A4A5E9	3-107	1A4A5R4	3-109	1A4A5R39	3-104
1A4A5E10	3-107	1A4A5R5	3-108	1A4A5R40	3-109
1A4A5E11	3-107	1A4A5R6	3-108	1A4A5T1	3-108
1A4A5E12	3-108	1A4A5R7	3-108	1A4A5T2	3-108
1A4A5E13	3-108	1A4A5R8	3-108	1A4A5T3	3-108
1A4A5E14	3-108	1A4A5R13	3-104	1A4A5Y1	3-109
1A4A5E15	3-104	1A4A5R14	3-105	1A5	2-2, 3-111
1A4A5HR1	3-109	1A4A5R15	3-104	1A5A1	3-113
1A4A5L1	3-102	1A4A5R16	3-105	1A5A1C1	3-114
1A4A5L2	3-103	1A4A5R17	3-104	1A5A1C2	3-114
1A4A5L3	3-103	1A4A5R18	3-104	1A5A1C3	3-114
1A4A5L4	3-103	1A4A5R19	3-105	1A5A1C4	3-114
1A4A5L5	3-104	1A4A5R20	3-108	1A5A1C5	3-114
1A4A5L6	3-104	1A4A5R21	3-109	1A5A1C6	3-114
1A4A5L7	3-104	1A4A5R22	3-108	1A5A1C7	3-115
1A4A5Q1	3-108	1A4A5R23	3-104	1A5A1C8	3-115
1A4A5Q2	3-108	1A4A5R24	3-105	1A5A1C9	3-115
1A4A5Q3	3-106	1A4A5R25	3-104	1A5A1C10	3-114
1A4A5Q4	3-108	1A4A5R26	3-104	1A5A1E1	3-113
1A4A5Q5	3-103	1A4A5R27	3-105	1A5A1E2	3-113
1A4A5Q6	3-103	1A4A5R28	3-104	1A5A1J1	3-115
1A4A5Q7	3-103	1A4A5R29	3-104	1A5A1J2	3-115
1A4A5Q8	3-103	1A4A5R30	3-104	1A5A1L1	3-114
1A4A5Q9	3-103	1A4A5R31	3-104	1A5A1L2	3-114
1A4A5Q10	3-103	1A4A5R32	3-105	1A5A1R1	3-114
1A4A5Q11	3-103	1A4A5R33	3-104	1A5A1R2	3-114
1A4A5Q12	3-103	1A4A5R34	3-105	1A5A1R3	3-114
1A4A5Q13	3-103	1A4A5R35	3-104	1A5A1R4	3-114

TM 11-5820-555-24P  
SECTION V INDEX-REFERENCE DESIGNATION  
CROSS REFERENCE TO PAGE NUMBER

REFERENCE DESIGNATION	PAGE NUMBER	REFERENCE DESIGNATION	PAGE NUMBER	REFERENCE DESIGNATION	PAGE NUMBER
1A5A1R5	3-114	1A5A2L1	3-140	1A5A3A1FL1	3-145
1A5A1T1	3-114	1A5A2L2	3-142	1A5A3A1J1	3-145
1A5A1T2	3-114	1A5A2L3	3-140	1A5A3A1J2	3-145
1A5A1TB1	3-115	1A5A2L4	3-141	1A5A3AIL1	3-144
1A5A1V1	3-114	1A5A2L5	3-140	1A5A3AIL2	3-144
1A5A2	3-138	1A5A2L6	3-142	1A5A3AIR1	3-144
1A5A2C1	3-140	1A5A2R1	3-140	1A5A3AIT1	3-144
1A5A2C2	3-140	1A5A2R2	3-142	1A5A3A1TB1	3-145
1A5A2C3	3-143	1A5A2R3	3-27	1A5A3A2	3-146
1A5A2C4	3-140	1A5A2R4	3-141	1A5A3A2C1	3-146
1A5A2C5	3-140	1A5A2R5	3-140	1A5A3A2C2	3-146
1A5A2C6	3-141	1A5A2R7	3-141	1A5A3A2C3	3-146
1A5A2C7	3-140	1A5A2R8	3-141	1A5A3A2C4	3-146
1A5A2C8	3-141	1A5A2R10	3-142	1A5A3A2C5	3-149
1A5A2C9	3-141	1A5A2R11	3-142	1A5A3A2CR1	3-146
1A5A2C10	3-141	1A5A2R12	3-142	1A5A3A2FL1	3-147
1A5A2C11	3-140	1A5A2TB1	3-140	1A5A3A2J1	3-147
1A5A2C12	3-140	1A5A2TB2	3-141	1A5A3A2J2	3-147
1A5A2C13	3-141	1A5A2V1	3-140	1A5A3A2L1	3-146
1A5A2C14	3-140	1A5A2V2	3-140	1A5A3A2L2	3-146
1A5A2C15	3-142	1A5A2V3	3-142	1A5A3A2R1	3-146
1A5A2C16	3-141	1A5A2Z1	3-140	1A5A3A2R2	3-146
1A5A2C17	3-141	1A5A2Z2	3-141	1A5A3A2R3	3-146
1A5A2C18	3-140	1A5A3	3-143	1A5A3A2R4	3-146
1A5A2CR1	3-142	1A5A3A1	3-144	1A5A3A2R5	3-146
1A5A2E1	3-139	1A5A3A1C1	3-144	1A5A3A2R6	3-146
1A5A2E2	3-139	1A5A3A1C2	3-144	1A5A3A2R7	3-146
1A5A2E3	3-139	1A5A3A1C3	3-127	1A5A3A2R8	3-146
1A5A2J1	3-139	1A5A3A1C4	3-144	1A5A3A2R9	3-146
1A5A2J2	3-139	1A5A3A1C5	3-149	1A5A3A2R10	3-146
1A5A2J3	3-139	1A5A3A1CR1	3-144	1A5A3A2R11	3-146

SECTION v INDEX-REFERENCE DESIGNATION  
CROSS REFERENCE TO PAGE NUMBER (CONTINUED)

REFERENCE DESIGNATION	PAGE NUMBER	REFERENCE DESIGNATION	PAGE NUMBER	REFERENCE DESIGNATION	PAGE NUMBER
1A5A3A2R12	3-146	1A5A4C29	3-136	1A5A4R17	3-134
1A5A3A2R13	3-147	1A5A4C30	3-138	1A5A4R19	3-135
1A5A3A2R14	3-147	1A5A4CR1	3-133	1A5A4R20	3-135
1A5A3A2T1	3-146	1A5A4CR2	3-133	1A5A4R21	3-135
1A5A4	3-132	1A5A4E1	3-132	1A5A4R22	3-135
1A5A4C1	3-136	1A5A4E2	3-134	1A5A4R23	3-135
1A5A4C2	3-136	1A5A4E3	3-134	1A5A4R24	3-134
1A5A4C3	3-136	1A5A4E4	3-134	1A5A4R25	3-135
1A5A4C4	3-136	1A5A4FL1	3-134	1A5A4R26	3-135
1A5A4C5	3-136	1A5A4J1	3-136	1A5A4R27	3-134
1A5A4C6	3-115	1A5A4J2	3-136	1A5A4R28	3-135
1A5A4C8	3-135	1A5A4L1	3-137	1A5A4R29	3-135
1A5A4C9	3-136	1A5A4L2	3-137	1A5A4R30	3-135
1A5A4C10	3-136	1A5A4P1	3-133	1A5A4R31	3-138
1A5A4C11	3-136	1A5A4Q1	3-133	1A5A4R32	3-136
1A5A4C12	3-136	1A5A4Q2	3-133	1A5A4R33	3-133
1A5A4C13	3-136	1A5A4Q3	3-133	1A5A4T1	3-137
1A5A4C14	3-136	1A5A4R1	3-138	1A5A4T2	3-134
1A5A4C15	3-136	1A5A4R2	3-134	1A5A4T3	3-134
1A5A4C16	3-133	1A5A4R3	3-134	1A5A4T4	3-137
1A5A4C17	3-136	1A5A4R4	3-135	1A5A4V1	3-133
1A5A4C18	3-136	1A5A4R5	3-134	1A5A4V2	3-133
1A5A4C20	3-132	1A5A4R6	3-138	1A5A4V3	3-133
1A5A4C21	3-133	1A5A4R7	3-135	1A5A4V4	3-133
1A5A4C22	3-133	1A5A4R9	3-135	1A5A5	3-126
1A5A4C23	3-133	1A5A4R10	3-135	1A5A5C1	3-130
1A5A4C24	3-133	1A5A4R12	3-134	1A5A5C2	3-129
1A5A4C25	3-136	1A5A4R13	3-135	1A5A5C3	3-130
1A5A4C26	3-136	1A5A4R14	3-135	1A5A5C4	3-130
1A5A4C27	3-136	1A5A4R15	3-135	1A5A5C5	3-129
1A5A4C28	3-136	1A5A4R16	3-135	1A5A5C6	3-130

TM 11-5820-555-24P  
SECTION v INDEX REFERENCE DESIGNATION  
CROSS REFERENCE TO PAGE NUMBER (CONTINUED)

REFERENCE DESIGNATION	PAGE NUMBER	REFERENCE DESIGNATION	PAGE NUMBER	REFERENCE DESIGNATION	PAGE NUMBER
1A5A5C7	3-129	1A5A5J2	3-130	1A5A5R28	3-129
1A5A5C8	3-129	1A5A5L1	3-131	1A5A5R29	3-129
1A5A5C9	3-130	1A5A5L2	3-131	1A5A5R30	3-128
1A5A5C10	3-130	1A5A5P1	3-127	1A5A5R31	3-132
1A5A5C11	3-129	1A5A5Q1	3-127	1A5A5R32	3-129
1A5A5C12	3-129	1A5A5Q2	3-127	1A5A5R33	3-127
1A5A5C13	3-130	1A5A5Q3	3-127	1A5A5T1	3-130
1A5A5C14	3-129	1A5A5R1	3-132	1A5A5T2	3-128
1A5A5C15	3-130	1A5A5R2	3-128	1A5A5T3	3-128
1A5A5C16	3-126	1A5A5R3	3-128	1A5A5T4	3-130
1A5A5C17	3-130	1A5A5R4	3-129	1A5A5V1	3-126
1A5A5C18	3-129	1A5A5R5	3-128	1A5A5V2	3-126
1A5A5C20	3-126	1A5A5R6	3-132	1A5A5V3	3-126
1A5A5C21	3-126	1A5A5R7	3-129	1A5A5V4	3-126
1A5A5C22	3-126	1A5A5R9	3-128	1A5A6	3-150
1A5A5C23	3-126	1A5A5R10	3-128	1A5A6C1	3-154
1A5A5C24	3-126	1A5A5R12	3-128	1A5A6C2	3-154
1A5A5C25	3-129	1A5A5R13	3-128	1A5A6C3	3-154
1A5A5C26	3-130	1A5A5R14	3-129	1A5A6C4	3-154
1A5A5C27	3-129	1A5A5R15	3-128	1A5A6C5	3-153
1A5A5C28	3-130	1A5A5R16	3-128	1A5A6C6	3-153
1A5A5C29	3-130	1A5A5R17	3-128	1A5A6C7	3-154
1A5A5C30	3-132	1A5A5R19	3-129	1A5A6C8	3-154
1A5A5CR1	3-127	1A5A5R20	3-129	1A5A6C9	3-154
1A5A5CR2	3-127	1A5A5R21	3-129	1A5A6C10	3-154
1A5A5E1	3-126	1A5A5R22	3-128	1A5A6C11	3-154
1A5A5E2	3-128	1A5A5R23	3-128	1A5A6C12	3-154
1A5A5E3	3-128	1A5A5R24	3-128	1A5A6C13	3-154
1A5A5E4	3-128	1A5A5R25	3-128	1A5A6C14	3-153
1A5A5FL1	3-128	1A5A5R26	3-128	1A5A6C16	3-154
1A5A5J1	3-130	1A5A5R27	3-128	1A5A6C18	3-151



TM 11-5820-555-24P  
**SECTION V INDEX-REFERENCE DESIGNATION**  
**CROSS REFERENCE TO PAGE NUMBER (CONTINUED)**

<u>REFERENCE DESIGNATION</u>	<u>PAGE NUMBER</u>	<u>REFERENCE DESIGNATION</u>	<u>PAGE NUMBER</u>	<u>REFERENCE DESIGNATION</u>	<u>PAGE NUMBER</u>
1A5A6C19	3-151	1A5A6R5	3-152	1A5A6T5	3-155
1A5A6C20	3-151	1A5A6R6	3-156	1A5A6V1	3-151
1A5A6C21	3-154	1A5A6R7	3-153	1A5A6V2	3-151
1A5A6C22	3-153	1A5A6R8	3-152	1A5A6V3	3-151
1A5A6C23	3-154	1A5A6R9	3-152	1A5A6V4	3-151
1A5A6C24	3-153	1A5A6R10	3-153	1A5A7	3-116
1A5A6C25	3-154	1A5A6R11	3-152	1A5A7C1	3-123
1A5A6C26	3-154	1A5A6R12	3-152	1A5A7C2	3-123
1A5A6C27	3-154	1A5A6R13	3-152	1A5A7C3	3-123
1A5A6C28	3-156	1A5A6R14	3-153	1A5A7C4	3-123
1A5A6C29	3-156	1A5A6R15	3-152	1A5A7C5	3-123
1A5A6C30	3-156	1A5A6R16	3-152	1A5A7C6	3-123
1A5A6CR1	3-151	1A5A6R18	3-153	1A5A7C7	3-123
1A5A6CR2	3-151	1A5A6R19	3-153	1A5A7C8	3-123
1A5A6CR3	3-151	1A5A6R20	3-153	1A5A7C9	3-123
1A5A6E1	3-150	1A5A6R21	3-153	1A5A7C10	3-123
1A5A6E2	3-152	1A5A6R22	3-153	1A5A7C11	3-123
1A5A6E3	3-152	1A5A6R23	3-155	1A5A7C12	3-123
1A5A6E4	3-152	1A5A6R24	3-153	1A5A7C13	3-123
1A5A6FL1	3-152	1A5A6R25	3-152	1A5A7C14	3-123
1A5A6J1	3-154	1A5A6R26	3-152	1A5A7C15	3-123
1A5A6J2	3-154	1A5A6R27	3-153	1A5A7C16	3-123
1A5A6L1	3-155	1A5A6R28	3-153	1A5A7C17	3-123
1A5A6P1	3-151	1A5A6R29	3-152	1A5A7C18	3-123
1A5A6Q1	3-151	1A5A6R30	3-156	1A5A7C19	3-123
1A5A6Q2	3-151	1A5A6R31	3-151	1A5A7C20	3-123
1A5A6Q3	3-151	1A5A6R32	3-156	1A5A7C21	3-123
1A5A6R1	3-156	1A5A6T1	3-155	1A5A7C22	3-123
1A5A6R2	3-152	1A5A6T2	3-155	1A5A7C23	3-123
1A5A6R3	3-152	1A5A6T3	3-152	1A5A7C24	3-123
1A5A6R4	3-153	1A5A6T4	3-152	1A5A7C25	3-123

TM 11-5820-555-24P  
SECTION V INDEX-REFERENCE DESIGNATION  
CROSS REFERENCE TO PAGE NUMBER

REFERENCE DESIGNATION	PAGE NUMBER	REFERENCE DESIGNATION	PAGE NUMBER	REFERENCE DESIGNATION	PAGE NUMBER
1A5A7C26	3-123	1A5A7J4	3-122	1A5A7R17	3-124
1A5A7C27	3-123	1A5A7J5	3-122	1A5A7R18	3-119
1A5A7C28	3-124	1A5A7J6	3-122	1A5A7R19	3-119
1A5A7C29	3-124	1A5A7J7	3-122	1A5A7R20	3-119
1A5A7C30	3-124	1A5A7J8	3-122	1A5A7R21	3-119
1A5A7C31	3-124	1A5A7J9	3-122	1A5A7R22	3-125
1A5A7C32	3-124	1A5A7J10	3-122	1A5A7R23	3-125
1A5A7C33	3-124	1A5A7J11	3-122	1A5A7R24	3-125
1A5A7C34	3-124	1A5A7J12	3-122	1A5A7R25	3-121
1A5A7C35	3-124	1A5A7J13	3-122	1A5A7R31	3-125
1A5A7C36	3-124	1A5A7J14	3-122	1A5A7S1	3-116
1A5A7C37	3-120	1A5A7K1	3-116	1A5A7S2	3-116
1A5A7C38	3-120	1A5A7K2	3-125	1A5A7S4	3-125
1A5A7CR1	3-119	1A5A7M1	3-116	1A5A7S5	3-125
1A5A7CR2	3-119	1A5A701	3-116	1A5A7T1	3-116
1A5A7CR3	3-119	1A5A704	3-125	1A5A7T2	3-116
1A5A7CR4	3-119	1A5A705	3-125	1A5A7T3	3-116
1A5A7CR5	3-119	1A5A7R2	3-118	1A5A7T4	3-116
1A5A7CR6	3-119	1A5A7R3	3-118	1A5A7TB1	3-119
1A5A7CR7	3-119	1A5A7R4	3-118	1A5A7V1	2-2, 3-117
1A5A7E1	3-118	1A5A7R5	3-119	1A5A7XV1	3-117
1A5A7E4	3-117	1A5A7R6	3-120	1A6	2-6, 3-232
1A5A7E5	3-117	1A5A7R7	3-120	1A6C1	3-237
1A5A7E6	3-117	1A5A7R8	3-120	1A6C2	3-237
1A5A7E7	3-117	1A5A7R9	3-120	1A6C3	3-237
1A5A7E8	3-117	1A5A7R10	3-120	1A6C4	3-237
1A5A7E9	3-117	1A5A7R11	3-120	1A6C5	3-237
1A5A7E10	3-117	1A5A7R12	3-119	1A6C6	3-237
1A5A7J1	3-122	1A5A7R13	3-119	1A6C7	3-237
1A5A7J2	3-122	1A5A7R15	3-118	1A6C8	3-237
1A5A7J3	3-122	1A5A7R16	3-118	1A6C9	3-236

SECTION V INDEX-REFERENCE DESIGNATION  
CROSS REFERENCE TO PAGE NUMBER (CONTINUED)

REFERENCE DESIGNATION	PAGE NUMBER	REFERENCE DESIGNATION	PAGE NUMBER	REFERENCE DESIGNATION	PAGE NUMBER
1A6C10	3-237	1A6M1	3-235	1A6R27	3-243
1A6C11	3-237	1A601	3-235	1A6R28	3-239
1A6C13	3-236	1A602	3-235	1A6R29	3-239
1A6C14	3-236	1A603	3-235	1A6R30	3-243
1A6C15	3-236	1A604	3-235	1A6S1	3-236
1A6C16	3-236	1A6R1	3-237	1A6S2	3-236
1A6C17	3-239	1A6R2	3-237	1A6S3	3-235
1A6C18	3-239	1A6R3	3-237	1A6S4	3-235
1A6C19	3-239	1A6R4	3-237	1A6T1	3-236
1A6C20	3-239	1A6R5	3-238	1A6TB1	3-239
1A6C21	3-239	1A6R6	3-237	1A6V1	2-6, 3-236
1A6C22	3-239	1A6R7	3-237	1A6V2	2-6, 3-236
1A6C27	3-243	1A6R8	3-237	1A6XDS1	3-235
1A6CR1	3-236	1A6R9	3-237	1A6XDS2	3-235
1A6CR2	3-236	1A6R10	3-237	1A6XV1	3-236
1A6CR3	3-236	1A6R11	3-243	1A6XV2	3-236
1A6CR4	3-236	1A6R12	3-237	1A6A1	3-240
1A6CR5	3-236	1A6R13	3-237	1A6A1C1	3-242
1A6CR6	3-236	1A6R14	3-238	1A6A1C2	3-242
1A6DS1	2-6, 3-235	1A6R15	3-237	1A6A1C3	3-242
1A6DS2	2-6, 3-235	1A6R16	3-237	1A6A1C4	3-240
1A6DS3	2-6, 3-236	1A6R17	3-237	1A6A1C5	3-241
1A6CS4	3-236	1A6R18	3-235	1A6A1C6	3-241
1A6E1	3-235	1A6R19	3-235	1A6A1C7	3-241
1A6E2	3-235	1A6R20	3-237	1A6A1C8	3-241
1A6J1	3-236	1A6R21	3-237	1A6A1C9	3-241
1A6J2	3-236	1A6R22	3-242	1A6A1C10	3-242
1A6J3	3-236	1A6R23	3-243	1A6A1C11	3-240
1A6K1	3-236	1A6R24	3-243	1A6A1CR1	3-241
1A6L1	3-236	1A6R25	3-243	1A6A1L1	3-241
1A6L2	3-239	1A6R26	3-243	1A6A1Q1	3-241

SECTION v INDEX-REFERENCE DESIGNATION  
 CROSS REFERENCE TO PAGE NUMBER (CONTINUED)

REFERENCE DESIGNATION	PAGE NUMBER	REFERENCE DESIGNATION	PAGE NUMBER	REFERENCE DESIGNATION	PAGE NUMBER
1A6AIR1	3-241	1A7R9	3-207	1A7A1C104	3-201
1A6AIR3	3-241	1A7R10	3-206	1A7A1C105	3-203
1A6AIR7	3-241	1A7R11	3-206	1A7A1Q101	3-202
1A7	2-5, 3-201	1A7R12	3-206	1A7A1Q102	3-202
1A7C22	3-205	1A7R14	3-206	1A7AIR101	3-203
1A7C23	3-210	1A7R15	3-206	1A7AIR102	3-203
1A7E1	3-205	1A7R16	3-206	1A7AIR103	3-203
1A7E2	3-205	1A7R17	3-207	1A7AIR104	3-203
1A7E3	3-205	1A7R18	3-207	1A7AIR105	3-203
1A7J1	3-205	1A7R19	3-207	1A7AIR106	3-203
1A7J2	3-205	1A7R20	3-207	1A7AIR108	3-203
1A7J3	3-205	1A7R21	3-206	1A7AIR4109	3-202
1A7J4	3-205	1A7R22	3-207	1A7AIR110	3-203
1A7J5	3-206	1A7R23	3-207	1A7A1T101	3-203
1A7J6	3-206	1A7R24	3-207	1A7A1T102	3-203
1A7J7	3-206	1A7R25	3-207	1A7A1TB101	3-203
1A7J8	3-210	1A7R26	3-210	1A7A1XQ101	3-203
1A7J9	3-210	1A7R27	3-210	1A7A1ZI01	3-202
1A7K1	3-210	1A7R28	3-210	1A7A2	3-201
1A7L1	3-206	1A7S1	3-206	1A7A3	3-201
1A7L2	3-206	1A7T1	3-205	1A7A4	2-5, 3-210
1A701	3-208	1A7T2	3-205	1A7A4C201	3-211
1A702	3-210	1A7T3	3-205	1A7A4E201	3-211
1A7R1	3-206	1A7T4	3-205	1A7A4F201	2-5, 3-210
1A7R2	3-206	1A7T5	3-205	1A7A4Q201	3-211
1A7R3	3-206	1A7T6	3-205	1A7A4Q202	3-211
1A7R4	3-206	1A7T7	3-205	1A7A4R201	3-212
1A7R5	3-206	1A7A1	3-201	1A7A4R202	3-212
1A7R6	3-206	1A7A1C101	3-203	1A7A4R203	3-212
1A7R7	3-206	1A7A1C102	3-201	1A7A4R204	3-212
1A7R8	3-207	1A7A1C103	3-203	1A7A4R205	3-212



SECTION v INDEX-REFERENCE DESIGNATION  
CROSS REFERENCE TO PAGE NUMBER (CONTINUED)

REFERENCE DESIGNATION	PAGE NUMBER	REFERENCE DESIGNATION	PAGE NUMBER	REFERENCE DESIGNATION	PAGE NUMBER
1A7A4T201	3-211	1A8R10	3-220	1A10C2	3-158
1A7A4Z201	3-211	1A8S1	3-220	1A10C3	3-158
1A8	2-6, 3-216	1A8T1	3-220	1A10C4	3-162
1A8C1	3-220	1A8V1	2-6, 3-218	1A10C5	3-158
1A8C2	3-220	1A8V2	2-6, 3-218	1A10C6	3-158
1A8C3	3-220	1A8XV1	3-219	1A10CR1	3-259
1A8C4	3-220	1A8XV2	3-219	1A10CR5	3-159
1A8E6	3-218	1A9	2-6, 3-227	1A10CR6	3-160
1A8E7	3-218	1A9C1	3-227	1A10CR7	3-160
1A8E9	3-218	1A9C2	3-227	1A10CR8	3-160
1A8E10	3-219	1A9C3	3-227	1A10CR9	3-162
1ABE14	3-219	1A9CR1	3-228	1A10DS1	2-3, 3-158
1A8E15	3-219	1A9CR2	3-228	1A10F1	2-3, 3-158
1A8E16	3-219	1A9CR3	3-228	1A10T1	2-3, 3-158
1A8J1	3-219	1A9CR4	3-228	1A10J1	3-162
1A8J2	3-219	1A9J1	3-228	1A10J2	3-162
1A8J3	3-221	1A9J2	3-228	1A10L1	3-160
1A8J4	3-221	1A9J3	3-229	1A10L2	3-160
1A8M1	3-219	1A9K1	3-229	1A10L3	3-158
1A801	3-219	1A9L1	3-228	1A10R1	3-160
1A802	3-222	1A9R1	3-229	1A10R2	3-160
1A803	3-222	1A9R2	3-229	1A10R3	3-160
1A8R1	3-220	1A9R3	3-229	1A10R4	3-160
1A8R2	3-219	1A9R4	3-229	1A10R5	3-160
1MR3	3-220	1A9R5	3-229	1A10R6	3-160
1A3R4	3-220	1A9S1	3-227	1A10R7	3-160
1A8R5	3-220	1A9T1	3-228	1A10R8	3-160
1A8R6	3-220	1A9T2	3-228	1A10R9	3-162
1A8R7	3-220	1A9T3	3-229	1A10R10	3-162
1A8R8	3-219	1A10	2-2, 3-156	1A10S1	3-158
1A8R9	3-220	1A10C1	3-158	1A10T1	3-158

SECTION v INDEX-REFERENCE DESIGNATION  
 CROSS REFERENCE TO PAGE NUMBER (CONTINUED)

REFERENCE DESIGNATION	PAGE NUMBER	REFERENCE DESIGNATION	PAGE NUMBER	REFERENCE DESIGNATION	PAGE NUMBER
1A10TB1	3-160	1A12C21	3-170	1A12CR4	3-167
1A10TB2	3-160	1A12C22	3-170	1A12CR5	3-168
1A10TB3	3-159	1A12C23	3-170	1A12CR6	3-168
1A10XF1	3-158	1A12C24	3-170	1A12CR7	3-168
1A10XI1	2-3, 3-158	1A12C25	3-170	1A12CR8	3-168
1A11	2-5, 3-213	1A12C26	3-170	1A12CR9	3-145
1A11B1	3-213	1A12C27	3-170	1A12CR10	3-168
1A11C1	3-215	1A12C28	3-170	1A12CR11	3-168
1A11F1	2-5, 3-213	1A12C29	3-170	1A12CR12	3-168
1A11J1	3-215	1A12C30	3-170	1A12CR13	3-168
1A11S1	3-213	1A12C31	3-170	1A12CR14	3-168
1A11XF1	3-213	1A12C32	3-170	1A12CR15	3-168
1 A 1 2	2-3, 3-163	1A12C33	3-170	1A12CR16	3-168
1A12C1	3-163	1A12C34	3-170	1A12CR17	3-168
1A12C2	3-163	1A12C35	3-170	1A12CR18	3-168
1A12C5	3-169	1A12C36	3-170	1A12CR19	3-168
1A12C6	3-169	1A12C37	3-170	1A12CR20	3-168
1A12C7	3-169	1A12C38	3-170	1A12CR21	3-168
1A12C8	3-169	1A12C39	3-170	1A12CR22	3-168
1A12C9	3-169	1A12C40	3-170	1A12CR23	3-168
1A12C10	3-169	1A12C41	3-170	1A12CR24	3-168
1A2C11	3-169	1A12C42	3-170	1A12CR25	3-168
1A12C12	3-169	1A12C43	3-170	1A12CR26	3-168
1A12C13	3-169	1A12C44	3-170	1A12CR27	3-168
1A12C14	3-169	1A12C45	3-171	1A12CR28	3-168
1A12C15	3-169	1A12C46	3-171	1A12CR29	3-168
1A12C16	3-169	1A12C47	3-171	1A12CR30	3-168
1A12C17	3-169	1A12C48	3-171	1A12CR31	3-168
1A12C18	3-170	1A12CR1	3-167	1A12CR32	3-169
1A12C19	3-170	1A12CR2	3-167	1A12CR33	3-169
1A12C20	3-170	1A12CR3	3-167	1A12CR34	3-169

SECTION v INDEX-REFERENCE DESIGNATION  
CROSS REFERENCE TO PAGE NUMBER (CONTINUED)

REFERENCE DESIGNATION	PAGE NUMBER	REFERENCE DESIGNATION	PAGE NUMBER	REFERENCE DESIGNATION	PAGE NUMBER
1A12CR35	3-169	1A12A2DS2	3-255	1A13A1MP8	3-245
1A12CR36	3-169	1A13	3-243	1A13A1MP9	3-245
1A12CR37	3-169	1A13F1	2-7, 3-250	1A13A1MP10	3-245
1A12CR38	3-169	1A13F2	2-7, 3-250	1A13A2	3-245
1A12CR39	3-169	1F13H1	3-243	1A13A2CP1	3-249
1A12CR40	3-169	1A13H2	3-244	1A13A2H1	3-249
1A12CR41	3-169	1A13H3	3-244	1A13A2H2	3-249
1A12CR42	3-169	1A13H4	3-243	1A13A2H3	3-249
1A12CR43	3-169	1A13H5	3-244	1A13A2H4	3-249
1A12CR44	3-169	1A13H6	3-244	1A13A2H7	3-249
1A12DS1	2-3, 3-165	1A13H7	3-244	1A13A2W1	3-246
1A12DS2	2-3, 3-167	1A13MP1	3-243	1A13A2W1P1	3-246
1A12F1	2-3, 3-171	1A13MP2	3-243	1A13A2W1P2	3-246
1A12F2	2-3, 3-169	1A13MP3	3-243	1A13A2W2	3-245
1A12F3	2-3, 3-163	1A13MP5	3-244	1A13A2W2P1	3-245
1A12J1	3-163	1A13MP6	3-244	1A13A2W2P2	3-245
1A12K1	3-163	1A13MP7	3-244	1A13A2W3	3-249
1A12L1	3-163	1A13MP8	3-243	1A13A2W3P1	3-250
1A12L2	3-163	1A13R1	3-250	1A13A2W3P2	3-250
1A12MP1	3-171	1A13A1	3-244	1A13A2W4	3-246
1A12R1	3-163	1A13A1H1	3-244	1A13A2W4P1	3-246
1A12R2	3-163	1A13A1H2	3-244	1A13A2W4P2	3-246
1A12R3	3-163	1A13A1H3	3-244	1A13A2W5	3-245
1A12R4	3-163	1A13A1H7	3-244	1A13A2W5P1	3-245
1A12S1	3-171	1A13A1H8	3-245	1A13A2W5P2	3-245
1A12S2	3-171	1A13A1MP1	3-244	1A13A2W6	3-245
1S12T2	3-163	1A13A1MP2	3-244	1A13A2W6P1	3-245
1S12TB1	3-163	1A13A1MP3	3-244	1A13A2W6P2	3-245
1A12TB2	3-167	1A13A1MP4	3-244	1A13A2W7	3-245
1A12XDS1	3-167	1A13A1MP5	3-244	1A13A2W7P1	3-245
1A12XF1	3-167	1A13A1MP7	3-244	1A13A2W7P2	3-246

T M 1 1 - 5 8 2 0 - 5 5 5 - 2 4 P

SECTION v INDEX-REFERENCE DESIGNATION

CROSS REFERENCE TO PAGE NUMBER (continued)

REFERENCE DESIGNATION	PAGE NUMBER	REFERENCE DESIGNATION	PAGE NUMBER	REFERENCE DESIGNATION	PAGE NUMBER
1A13A2W8	3-245	1A13A2W19P1	3-247	1A14E2	3-252
1A13A2W8P1	3-246	1A13A2W19TBJ	3-247	1A14E3	3-252
1A13A2W8P2	3-246	1A13A2W20	3-247	1A14E4	3-252
1A13A2W9	3-246	1A13A2W20P1	3-247	1A14H1	3-253
1A13A2W9P1	3-246	1A13A2W20TBK	3-247	1A14H2	3-252
1A13A2W9P2	3-246	1A13A2W21	3-248	1A14J1	3-253
1A13A2W10	3-249	1A13A2W21P1	3-248	1A14MP1	3-253
1A13A2W10P1	3-249	1A13A2W21TBL	3-248	1A14MP2	3-253
1A13A2W10P2	3-249	1A13A2W22	3-248	1A14P1	3-252
1A13A2W11P1	3-247	1A13A2W22P1	3-248	1A14P2	3-252
1A13A2W11TBA	3-247	1A13A2W22TBM	3-248	1A14R1	3-253
T1A13A2W12	3-247	1A13A2W22TBP	3-248	1A14W1	3-252
1A13A2W12P1	3-247	1A13A2W23	3-248		
1A13A2W12TBB	3-247	1A13A2W23P1	3-248		
T1A13A2W13	3-247	1A13A2W23TBN	3-248		
1A13A2W13P1	3-247	1A13A2W24	3-248		
1A13A2W13TBC	3-247	1A13A2W24P1	3-248		
1A13A2W14	3-249	1A13A2W25	3-248		
1A13A2W14P1	3-249	1A13A2W25TBR	3-249		
1A13A2W14TBD	3-249	1A13A2W26	3-246		
1A13A2W15	3-247	1A13A2W26P1	3-246		
1A13A2W15P1	3-247	1A13A2W26TBS	3-246		
1A13A2W15TBE	3-247	1A13A2W27	3-249		
1A13A2W16	3-248	1A13A2W27P1	3-249		
1A13A2W16P1	3-248	1A13A2W27P2	3-249		
1A13A2W16TBF	3-248	1A13A3	3-250		
T1A13A2W17P1	3-247	1A13A3HT1	3-250		
1A13A2W17TBG	3-247	1A13A3MK1	3-250		
1A13A2W18	3-248	1A13A3S1	3-250		
1A13A2W18P1	3-248	1A14	2-7, 3-252		
1A13A2W18TBH	3-248	1A14E1	3-252		



By Order of the Secretary of the Army:

CREIGHTON W. ABRAMS  
*General, United States Army*  
*Chief of Staff*

Official:

VERNE L. BOWERS  
*Major General, United States Army*  
*The Adjutant General*

**Distribution:**

*Active Army:*

CNGB (1)  
**USASA (2)**  
**ACSC-E (2)**  
**USAMB (10)**  
AMC (1)  
**ARADCOM (2)**  
ARADCOM Rgn (1)  
OS Maj Comd (3)  
**USASTRATCOM (10)**  
USASTRATCOM-PAC (2)  
USASTRATCOM-EUR (50)  
USASTRATCOM-SO (2)  
USASTRATCOM-CONUS (5)  
USAINTS (3)  
HISA (ECOM) (31)  
USAREUR (10)  
7th USA (5)  
MAAG (Europe) (1)

NG: None

**USAR:** None

For explanation of abbreviations used, see AR 310-50.

**Army Dep (1) except**

**SAAD (10)**

**TOAD (10)**

LBAD (5)

**LEAD (7)**

**USA Dep (Eur) (2) except**

**Pirmaseans (10)**

**Sig Sec USA Dep (Eur) (4)**

**Sig Dep (Eur) (4)**

**USARMIS (Eur) (1)**

**Units org under for1 TOE: (2 cys ea)**

1 1-97

**11-98**

**11-117**

1 1-127

**11-158**

**1 1-302**

1 1-500 (AA-AC)

**END**

**11-26-82**

**DATE**





DEPARTMENT OF THE ARMY

MICROFORM  
TEST TARGET

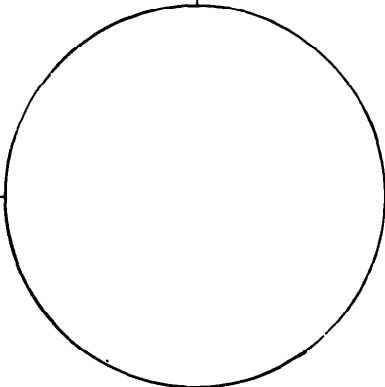
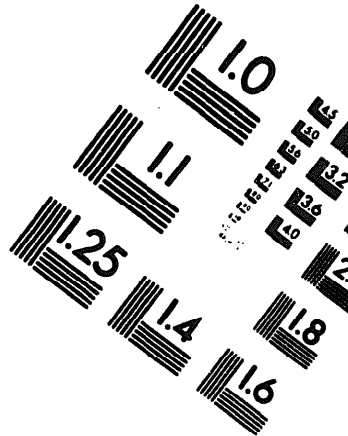
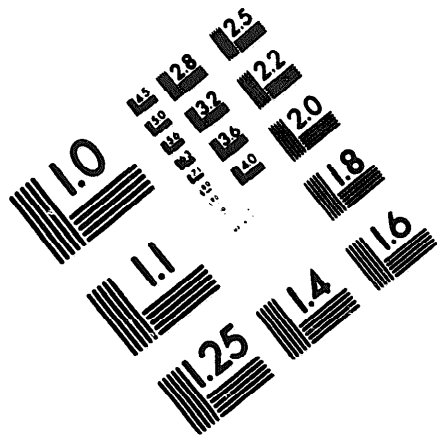

150 MM

1.0 mm (e= .81 mm)

ABCDEFGHIJKLMNQRSTUWXYZ1234567890  
abcdefghijklmnopqrstuvwxyz\$%&/'%# 1/2 1/4 3/4 —=+ x&@\*

1.5 mm (e= 1.09 mm)

ABCDEFGHIJKLMNQRSTUWXYZ1234567890  
abcdefghijklmnopqrstuvwxyz\$%&/'%# 1/2 1/4 3/4 —=+ x&@\*

2.0 mm (e= 1.37 mm)

ABCDEFGHIJKLMNQRSTUWXYZ  
abcdefghijklmnopqrstuvwxyz  
1234567890\$%&/'%# 1/2 1/4 3/4 —=+ x&@\*

2.5 mm (e= 1.77 mm)

ABCDEFGHIJKLMNQRSTUWXYZ  
abcdefghijklmnopqrstuvwxyz  
1234567890\$%&/'%# 1/2 1/4 3/4 —=+ x&@\*

1.0 mm (e= .81 mm)

ABCDEFGHIJKLMNQRSTUWXYZ1234567890  
abcdefghijklmnopqrstuvwxyz\$%&/'%# 1/2 1/4 3/4 —=+ x&@\*

1.5 mm (e= 1.09 mm)

ABCDEFGHIJKLMNQRSTUWXYZ1234567890  
abcdefghijklmnopqrstuvwxyz\$%&/'%# 1/2 1/4 3/4 —=+ x&@\*

2.0 mm (e= 1.37 mm)

ABCDEFGHIJKLMNQRSTUWXYZ  
abcdefghijklmnopqrstuvwxyz  
1234567890\$%&/'%# 1/2 1/4 3/4 —=+ x&@\*

2.5 mm (e= 1.77 mm)

ABCDEFGHIJKLMNQRSTUWXYZ  
abcdefghijklmnopqrstuvwxyz  
1234567890\$%&/'%# 1/2 1/4 3/4 —=+ x&@\*

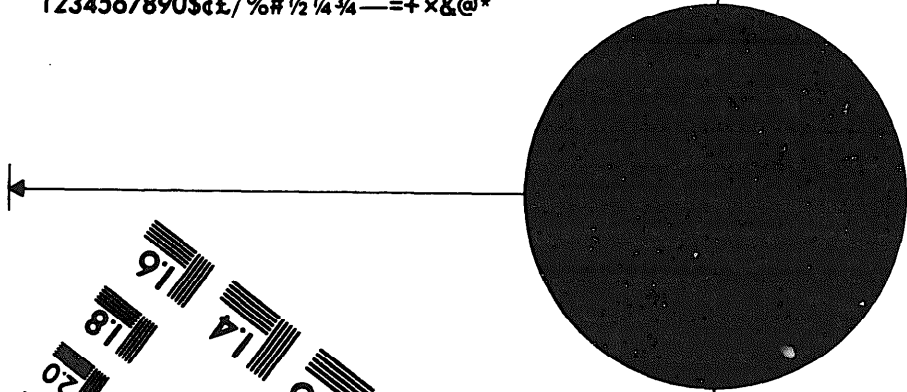
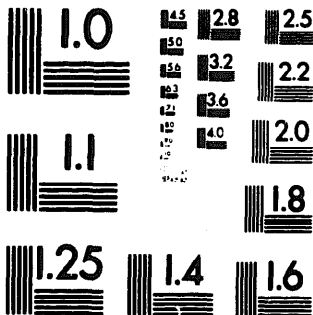

200 MM

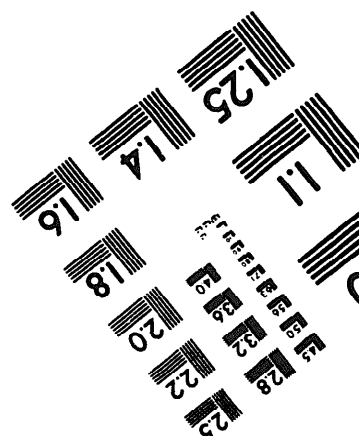
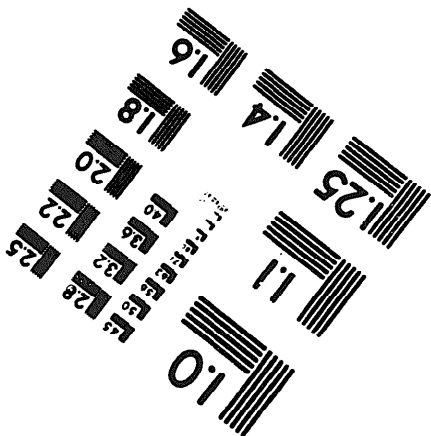

250 MM